



Barovier&Toso

VENEZIA 1295

Work Book



Enlightening Uniqueness

In sette secoli di storia abbiamo visto mode andare e venire. Alcune minimaliste, altre più barocche, ma tutte ugualmente prese ad inseguire il tempo che passa, nella disperata ricerca del "nuovo".

A Venezia il tempo, invece, scorre lento. Non c'è fretta, solo tempo e spazio necessari per affinare un'arte.

Così, abbiamo deciso di prenderci il nostro tempo, per fare qualcosa di unico e originale. Qualcosa che possa durare per sempre. Qualcosa che vada oltre il fascino effimero di una stagione.

Ci vuole forza per plasmare il vetro dalla sabbia e dal fuoco. Ci vuole pazienza per arrivare alla forma perfetta senza compromessi e ci vuole cuore, tanto cuore, per portare una tradizione leggendaria di illuminazione di lusso fino ai giorni nostri, in un perfetto equilibrio tra passato, presente e futuro.

Ma ancora una volta possiamo permetterci il lusso del tempo. E forse, anche voi.

In seven centuries of history, we have seen fashions come and go. Some were minimal, others more baroque, but every one of them chased time in a desperate search for the "new."

Time in Venice, instead, goes by slowly. There is no rush, no craze, just a great deal of space and time to develop your craft.

So we took our time and in that time we have learned that we would rather do something unique and enlightening that lasts forever instead of something new that only fascinates you for one season.

It takes strength to bring glass out from the fire and heat. It takes patience to strive for nothing less than the perfect shape. And it takes heart, a lot of it, to grow a legendary luxury lighting tradition into the new world, working with innovators and traditionalists alike.

But again, we can afford the luxury of time. And perhaps, so can you.





Cristallo Veneziano | *Venetian Crystal*

Le creazioni Barovier&Toso sono opere uniche, in Cristallo Veneziano soffiato a bocca e realizzate a mano da maestri vetrai di Murano, depositari di una tradizione secolare che solca la storia da generazioni.

È ad Angelo Barovier che si deve l'invenzione di una rivoluzionaria formula che permise di ottenere un materiale inedito, dalle straordinarie caratteristiche di estrema trasparenza e brillantezza. Fu con decreto della Repubblica di Venezia, intorno al 1455, che Angelo Barovier ottenne addirittura l'esclusiva nella produzione del "Cristallo Veneziano".

Ciò che ancora oggi rende unica quella ricetta materica, giunta fino a noi e ulteriormente perfezionata, è la totale assenza di piombo e arsenico. Questo distingue il nostro Cristallo Veneziano da qualunque altro cristallo in commercio e rende la tecnica del cristallo soffiato, come anche tutto il processo produttivo, eseguibile in totale sicurezza da parte dei maestri vetrai.

Il Cristallo Veneziano è un materiale unico, sostenibile e sicuro, capace di dar forma ad opere di grande valore artistico, le creazioni Barovier&Toso.

Barovier&Toso produce esclusivamente Cristallo Veneziano.

The creations of Barovier&Toso are one-of-a-kind works in Venetian mouth blown Crystal and hand crafted by master artisans in Murano, custodians of an age-old tradition passed down across the generations.

Angelo Barovier invented a revolutionary formula that made it possible to obtain an unprecedented material with extraordinary characteristics of extreme transparency and brightness. Thanks to a decree issued by the Republic of Venice in 1455, Angelo Barovier was granted the exclusive right to produce "Cristallo Veneziano" (Venetian Crystal).

The factor that makes this formula unique, still used today through progressive refinements, is the total absence of lead and arsenic. This is what makes our Venetian Crystal different from any other crystal on the market, enabling the master artisans to carry out the entire production process in complete safety, achieving exceptional results.

The Venetian Crystal is a unique, sustainable and safe material, ideal to give form to works of great artistic value: the creations of Barovier&Toso.

Barovier&Toso produces exclusively Venetian Crystal.

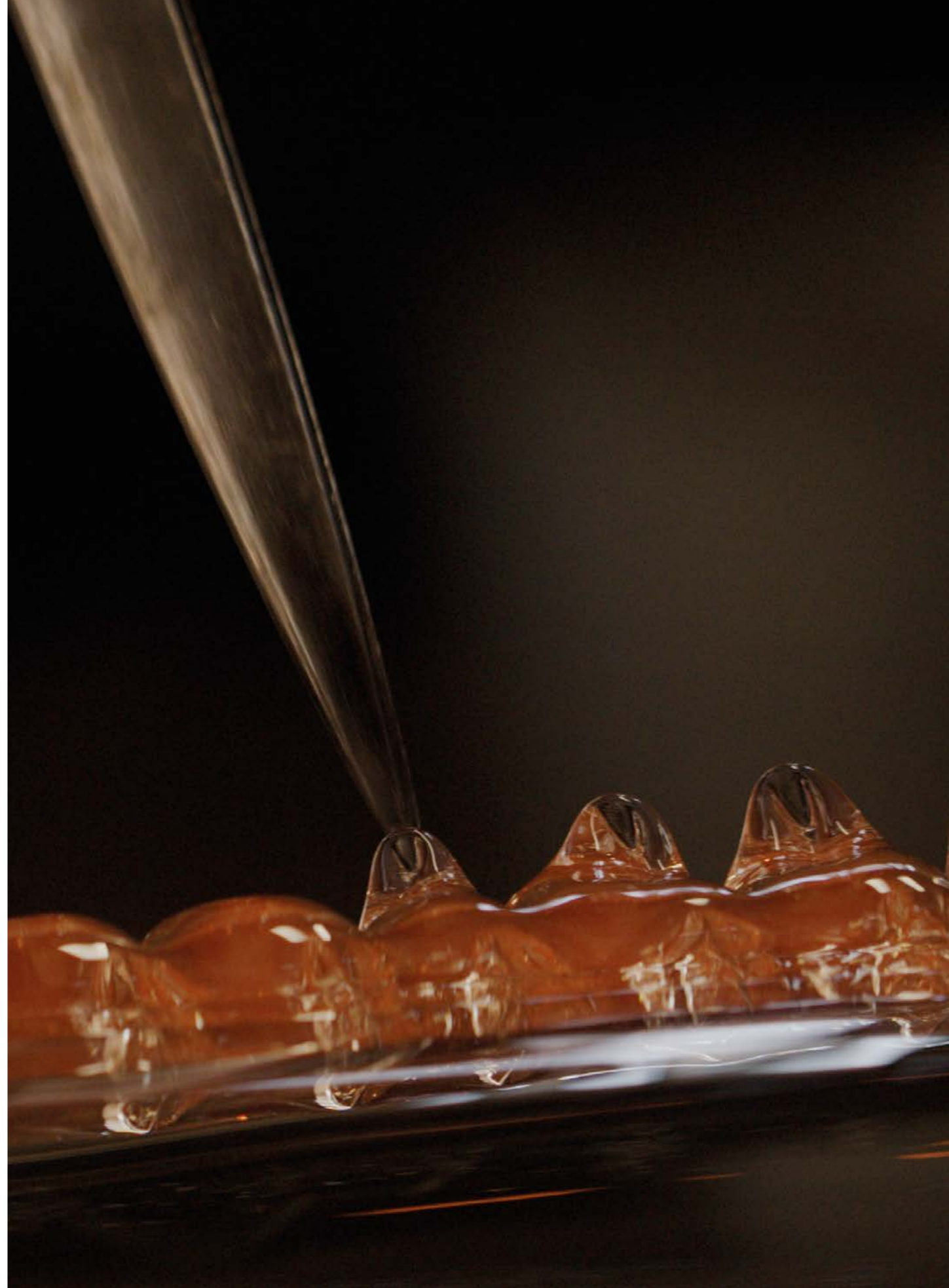

CHANDELIERS



4604
24

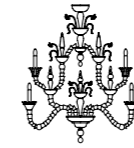

4607
26

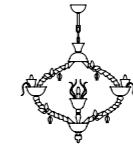

Adonis
28

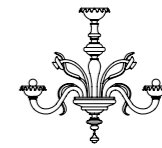

Agadir
32

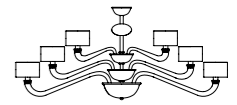

Alexandria
34

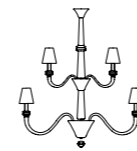

Amsterdam
36

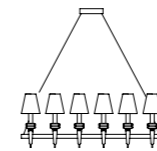

Domo Amsterdam
36

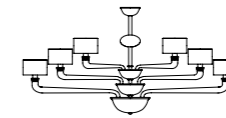

Babylon
42

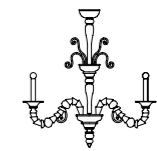

Baikal
44

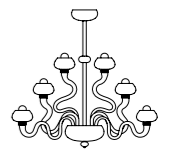

Bissa Boba
46

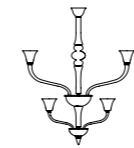

Degas
48

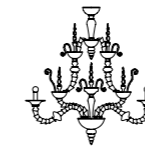

Dhamar
50

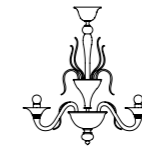

Fauve
52

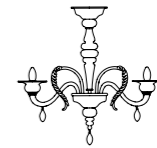

Fez
54

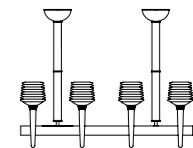

Florian
56

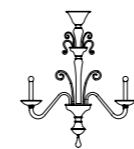

Izmir
58

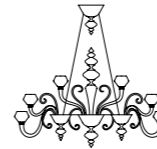

Magritte
60

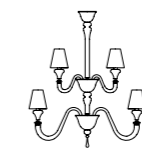

Maryland
64



Meknes
68

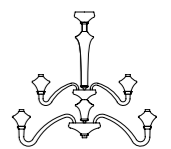

Metropolis
70

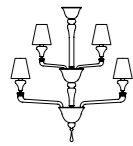

Nevada
74

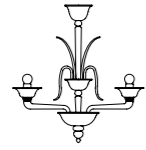

Odile
78



Palladiano
80

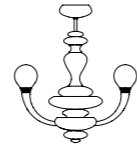

Pigalle
84

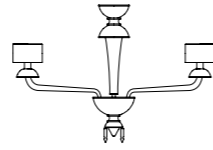

Première Dame
86

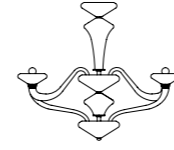

Windsor
130

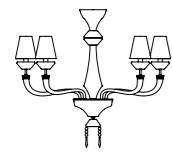

Président
88



Rabat
92

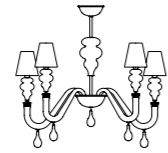

Ran Round
94

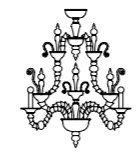

Riyadh
98

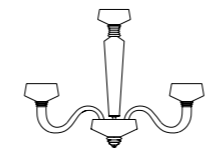

Rosati
100

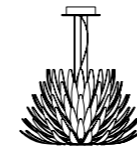

Agave
134

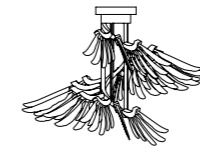

Angel
136



Campanula
138



Clepsydra
142

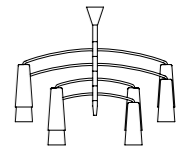

Colimaçon
146

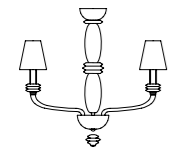

Rotterdam
104

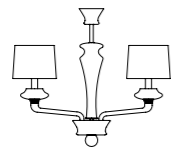

Saint Germain
108



San Giorgio
110

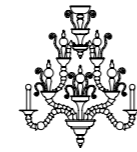

Taif
112

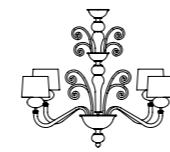

Tangeri
114

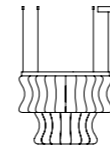

Crown
150

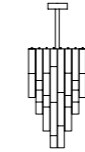

Empire
154

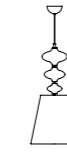

Eva
156

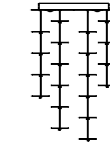

Exagon
158

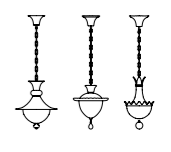

Fanali Veneziani
160

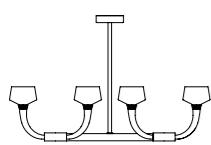

Twins
116

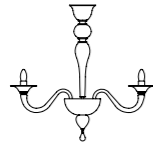

Valiant
118



Venezia 1295
120

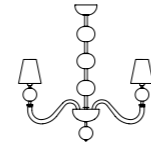

Vermont
124

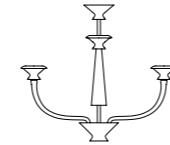

Vertigo
126

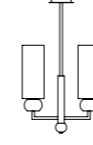

Gallia
164

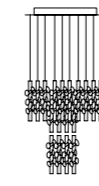

Germogli
166

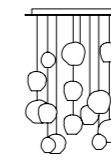

Hanami
170

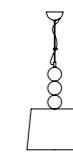

Marta
174

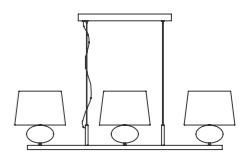

Matrioska
176

SUSPENSIONS

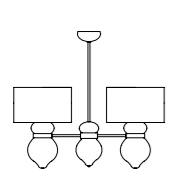

Medina
180

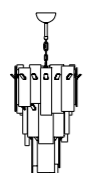

Midtown
182

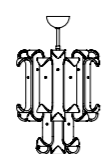

New Felci
186

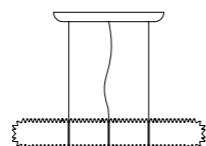

Opéra
190

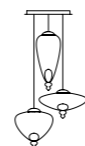

Padma
194



Webb
240

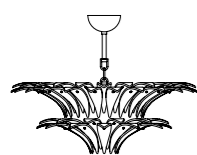

Palmette
198

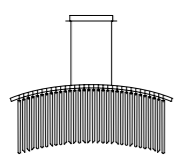

Palmyra
202

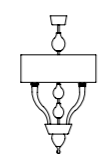

Pandora
206

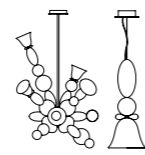

Perseus
208



Pigalle
210



Agave
244

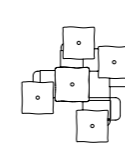

Alumina
246



Anversa
248

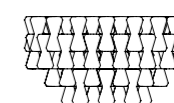

Clepsydra
250

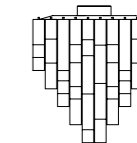

Empire
252

CEILING

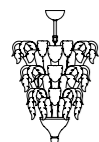

Piume
212

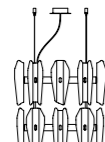

Punk
216

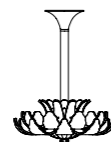

Rex
218



Robin
220

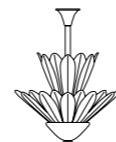

Spade
222



Excelsior
254

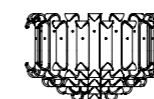

New Felci
258

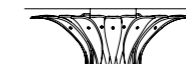

Palmette
260



Pigalle
262

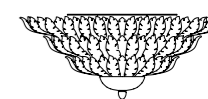

Piume
264

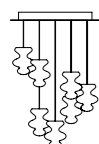

Spinn
224

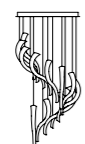

Swing
228

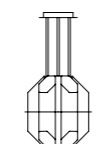

Trim
232



Vallonné
234

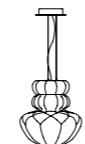

Vallonné Opale
238



Plissé
266

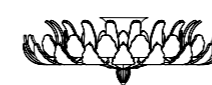

Rex
268



Spade
272



Topkapi
274

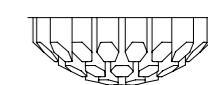

Trim
276

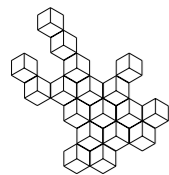

Webb
280



Degas
314



Dhamar
316



Empire
318

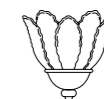

Excelsior
320



Fauve
322

WALL



4604
286



4607
288



Adonis
290



Agadir
292



Agave
294



Fez
324

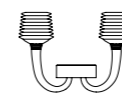

Florian
326



Gallia
328



Izmir
330



Magritte
332

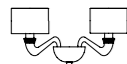

Alexandria
296

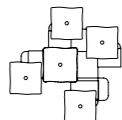

Alumina
298

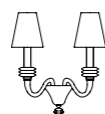

Amsterdam
300

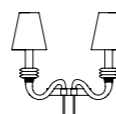

Domo Amsterdam
300



Angel
302

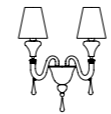

Maryland
334

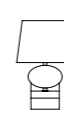

Matrioska
336



Medina
338



Meknes
340



Metropolis
342

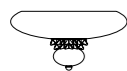

Anversa
304

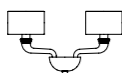

Babylon
306

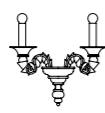

Baikal
308

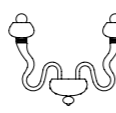

Bissa Boba
310



Clepsydra
312

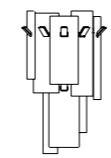

Midtown
344



Nevada
346

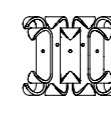

New Felci
348

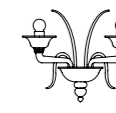

Odile
350

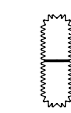

Opéra
352

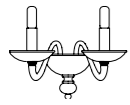

Palladiano
354



Palmette
356

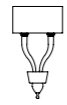

Pandora
358



Perseus
360



Pigalle
362



Torvik
394

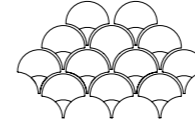

Tuileries
396

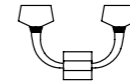

Twins
400



Valiant
402



Venezia 1295
404



Piume
364



Plissé
366

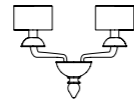

Première Dame
368

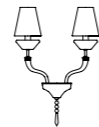

Président
370



Rabat
372

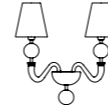

Vermont
406



Vertigo
408



Webb
410

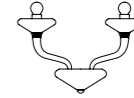

Windsor
414

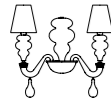

Ran Round
374



Rex
376



Riyadh
378

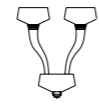

Rosati
380

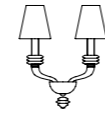

Rotterdam
382

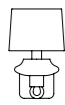

Saint Germain
384



San Giorgio
386



Spade
388



Taif
390

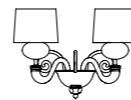

Tangeri
392

TABLE

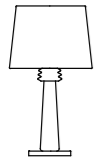

Amsterdam
418



Camparino
420

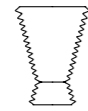

Ercole
422



Eva
424

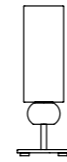

Gallia
426

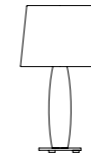

Twins
458

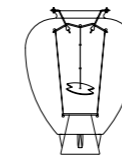

Veronese
460



Grace
428

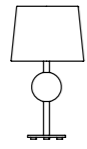

Marta
430

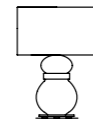

Medina
432

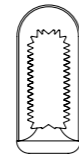

Opéra
434



Padma
436

FLOOR

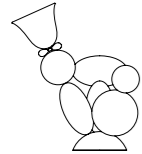

Perseus
438



Pigalle
440

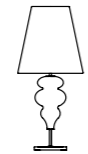

Ran
442

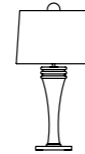

Rive Gauche
444

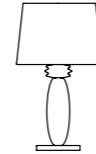

Rotterdam
446



Amsterdam
464

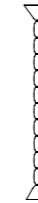

Conterie
466



Ercole
468



Eva
470



Gallia
472

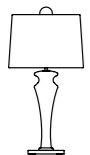

Saint Germain
448



Samurai
450

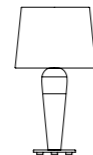

Sara
452



Sideris
454



Trinitas
456

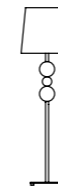

Marta
474



Opéra
476

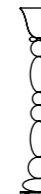

Perseus
478



Rotterdam
480



Samurai
482



CHANDELIERS

Opere d'arte intessute di luce, portatrici indiscusse di eleganza e regalità. Dai lampadari più moderni a quelli di concezione barocca dove, in modo lineare o radiale, i bracci si moltiplicano a cascata, dando vita a spettacolari effetti luminosi.

Works of art woven by light, unrivalled vehicles of regal elegance. From the most modern chandeliers to those in Baroque style, the arms multiply in linear or radial arrangements, giving rise to spectacular luminous effects.

4604

Tra i lampadari veneziani, 4604 si distingue per la sua leggerezza decorativa. Le foglie, i pinnacoli e i fiori che lo adornano possono essere realizzati tono su tono o a contrasto; elementi caratterizzanti nelle tonalità del cristallo, dell'oro e del blu che fanno di questo modello un'icona d'arredo. La collezione comprende tre lampadari.

Among the Venetian chandeliers, 4604 stands out for its decorative lightness: leaves, pinnacles and the flowers that adorn it are crystal-coloured or gilded at the most, which makes them less present but still characteristic. The collection consists of three chandeliers.



Modelli e misure Models and sizes

*Ogni modello prevede una catena di 100 cm inclusa.
Every model is supplied with a 100 cm (39 1/4") chain.

	4604 4604-09	4604 4604-12	4604 4604-18
Peso Weight	35 kg 77 lb	50 kg 110 lb	60 kg 132 lb
Lampadine Bulbs	N. Tipo W max. 9 E14 60	N. Tipo W max. 12 E14 60	N. Tipo W max. 18 E14 60
Dimmerabile Dimmable	D	D	D
Lampadine incluse Bulbs included	(01)	(01)	(01)
Certificazioni Certification Marks			

Colori disponibili Available colours



CC
Cristallo
Crystal



CU
Cristallo/
Decoro Bluastro
Crystal/ Bluastro
Decoration



DO
Cristallo/
Decoro Oro
Crystal/ Gold
Decoration



***OO**
Oro
Gold
*Solo OG
Only OG



PC
Policromo
Polychrome

Finiture Finishings



CL
Cromo Lucido
Polished Chrome



***OG**
Oro Galvanizzato
Galvanized Gold
*Solo OO
Only OO

4607

Il più classico dei lampadari veneziani, imponente nella la sua magnificenza. Fiori in pasta di vetro multicolore, una moltitudine di decorazioni e la purezza trasparente del cristallo, fanno di 4607 un lampadario destinato ai più importanti palazzi sul Canal Grande.

The most classic Venetian chandelier, impressive in its magnificence. Flowers in multi-coloured glass paste, a multitude of decorations and the transparent purity of the crystal make 4607 a chandelier suitable to the most important palaces on the Grand Canal.



Modelli e misure Models and sizes

*Ogni modello prevede una catena di 100 cm inclusa.
Every model is supplied with a 100 cm (39 1/4") chain.

	4607 4607-12	4607 4607-20	4607 4607-36
Peso Weight	65 kg 143 lb	115 kg 253 lb	220 kg 484 lb
Lampadine N. Tipo W max. Bulbs N. Type W max.	12 E14 60 E12 60	20 E14 60 E12 60	36 E14 60 E12 60
Dimmerabile Dimmable	D	D	D
Lampadine incluse Bulbs included			
Certificazioni Certification Marks			

Colori disponibili Available colours



CC
Cristallo
Crystal



CU
Cristallo/
Decoro Bluastro
Crystal/ Bluastro
Decoration



DO
Cristallo/
Decoro Oro
Crystal/ Gold
Decoration



***OO**
Oro
Gold
*Solo OO
Only OO



PC
Policromo
Polychrome

Finiture Finishings



CL
Cromo Lucido
Polished Chrome



***OG**
Oro Galvanizzato
Galvanized Gold
*Solo OO
Only OO

ADONIS

Marcel Wanders

Adonis è una collezione creata da Marcel Wanders, ispirata alla tradizione floreale olandese e contaminata da quella vetraria muranese che, da sempre, usa i fiori come elemento distintivo. Leggiadre farfalle e boccioli di tulipano adornano i bracci di tutti i modelli, in un vortice di colori. Si compone di sei lampadari di due diverse fogge - una allungata e una più tradizionale - che possono essere combinati tra loro in un sistema modulare ad elevata personalizzazione.

Adonis is a collection created by Marcel Wanders, inspired by the Dutch floral tradition and fused with Murano glassmaking, which has always used flowers as a distinctive feature. Graceful butterflies and tulip buds adorn the arms of every model, in a swirl of colour. It is comprised of six chandeliers in two different styles - one elongated, the other more traditional - that can be combined in a modular system for the ultimate in personalization.



Modelli e misure
Models and sizes

*Ogni modello prevede una catena di 100 cm inclusa.
Every model is supplied with a 100 cm (39 1/4") chain.

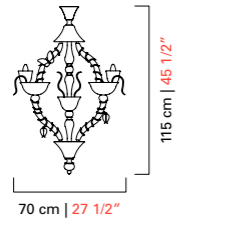
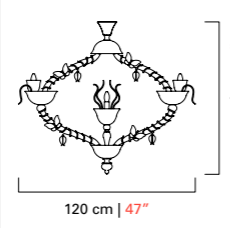
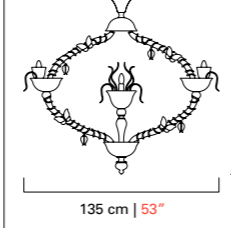
	Adonis 7360-04	Adonis 7360-11	Adonis 7360-13
			
Peso Weight	22 kg 48 lb	30 kg 66 lb	38 kg 84 lb
Lampadine N. Tipo W max. Bulbs N. Type W max.	4 E14 60 E12 60	11 E14 60 E12 60	13 E14 60 E12 60
Dimmerabile Dimmable	D	D	D
Lampadine incluse Bulbs included			
Certificazioni Cerification Marks			

Modelli e misure
Models and sizes

*Ogni modello prevede una catena di 100 cm inclusa.
Every model is supplied with a 100 cm (39 1/4") chain.

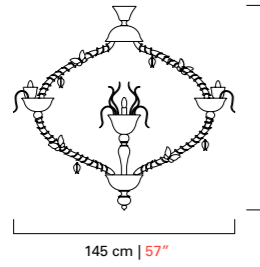
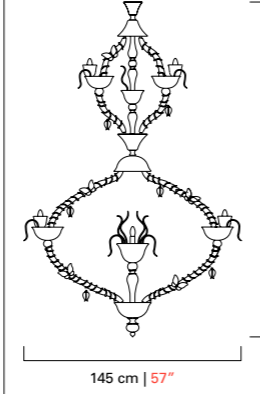
	Adonis 7360-17	Adonis 7360-21
		
Peso Weight	55 kg 121 lb	77 kg 170 lb
Lampadine N. Tipo W max. Bulbs N. Type W max.	17 E14 60 E12 60	21 E14 60 E12 60
Dimmerabile Dimmable	D	D
Lampadine incluse Bulbs included		
Certificazioni Cerification Marks		

Colori disponibili
Available colours



CC
Cristallo
Crystal



AU
Cristallo/Verde
Antalia/ Cedro
Liquido
Crystal/ Antalia
Green/ Liquid Citron



LA
Cristallo/ Bluastro/
Acquamare
Crystal/ Bluastro/
Aquamarine



LN
Cristallo/ Caramello/
Cognac
Crystal/ Caramel/
Cognac



EU
Bianco/ Rubino/
Rosè
White/ Ruby/ Light
Pink

Finiture
Finishings



CL
Cromo Lucido
Polished Chrome



***OG**
Oro Galvanizzato
Galvanized Gold
*Solo CC e LN
Only CC and LN

AGADIR

Prende ispirazione dalla città di Agadir, sulla costa meridionale atlantica del Marocco, con i suoi fiori, foglie lavorazioni a spirale molto ricche. Una collezione di quattro lampadari che è stata rieditata a partire da disegni storici dell'archivio Barovier&Toso, riadattata ora con colori eleganti e preziosi. Due modelli hanno altezza ridotta (con otto o dodici luci) mentre i modelli a sedici o diciotto luci sono più adatti a soffitti alti.

It takes inspiration from the city of Agadir, on the southern Atlantic coast of Morocco, with its flowers, leaves and very rich spiral works. It is a collection of four chandeliers that derives from historical drawings of the Barovier&Toso archives but has been endowed with new elegant and sophisticated colors. Two models come in a reduced height (with eight or twelve arms) while the models with sixteen or eighteen arms are more suitable for high ceilings.



Modelli e misure Models and sizes

*Ogni modello prevede una catena di 100 cm inclusa.
Every model is supplied with a 100 cm (39 1/4") chain.

	Agadir 5384-08	Agadir 5384-12	Agadir 5384-16	Agadir 5384-18
Peso Weight	15 kg 33 lb	20 kg 44 lb	25 kg 55 lb	30 kg 66 lb
Lampadine Bulbs	N. Tipo W max. 8 E14 60	N. Tipo W max. 12 E14 60	N. Tipo W max. 16 E14 60	N. Tipo W max. 18 E14 60
Dimmerabile Dimmable	D	D	D	D
Lampadine incluse Bulbs included				
Certificazioni Certification Marks				

Colori disponibili Available colours



CC
Cristallo
Crystal



CU
Cristallo/
Decoro Bluastro
Crystal/ Bluastro
Decoration



DO
Cristallo/
Decoro Oro
Crystal/ Gold
Decoration



***OO**
Oro
Gold
*Solo OG
Only OG

Finiture Finishings



CL
Cromo Lucido
Polished Chrome



***OG**
Oro Galvanizzato
Galvanized Gold
*Solo OO
Only OO

ALEXANDRIA

Una collezione moderna di lampadari, composta da quattro modelli, il cui segno distintivo è l'altezza ridotta (46 cm per il modello più piccolo fino ad un massimo di 70 cm), particolarmente adatta per illuminare ambienti in cui l'altezza non consentirebbe l'utilizzo di un lampadario tradizionale. I paralumi sono in tessuto plissettato.

A collection of chandeliers with lampshade, of four models, whose distinctive sign is the reduced height (18" for the smallest model up to a maximum of 27 1/2"), particularly suitable to illuminate rooms whose height would not allow the use of a traditional chandelier. The lampshades are made of pleated fabric.



Modelli e misure Models and sizes

*Ogni modello prevede una catena di 100 cm inclusa.
Every model is supplied with a 100 cm (39 1/4") chain.

	Alexandria 5597-08	Alexandria 5597-16	Alexandria 5597-24	Alexandria 5597-30
	 84,5 cm 33" 45,5 cm 17 1/2"	 125 cm 49 1/4" 60 cm 23 1/2"	 160 cm 62 1/2" 60 cm 23 1/2"	 160 cm 62 1/2" 70 cm 27 1/2"
Peso Weight	10 kg 22 lb	16 kg 35 lb	22 kg 48 lb	26 kg 57 lb
Lampadine N. Tipo W max. Bulbs N. Type W max.	8 E14 60 E12 60	16 E14 60 E12 60	24 E14 60 E12 60	30 E14 60 E12 60
Dimmerabile Dimmable	D	D	D	D
Lampadine incluse Bulbs included				
Certificazioni Certification Marks				

Colori disponibili Available colours



CC
Cristallo
Crystal



IC
Grigio
Grey



EK
Sabbia
Sand



DK
Oliva
Olive



AK
Blu Cadetto
Cadet Blue



LQ
Bluastro
Bluastro



FK
Indaco
Indigo



CK
Pervinca
Periwinkle



VI
Viola
Violet



***OO**
Oro
Gold
*Solo OG
Only OG

Finiture Finishings



CN
Cromo Nero
Dark Chrome



***OG**
Oro Galvanizzato
Galvanized Gold
*Solo OO
Only OO

Paralumi Shades

Nastro Pongè
Pongee Ribbon

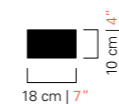

BB
Bianco
White



NN
Nero
Black

AMSTERDAM

Il fascino discreto della luce soffusa, calda e avvolgente. Una collezione che gioca con l'alternanza fra volumi opachi e volumi trasparenti, un dialogo fra lavorazioni diverse che esaltano la fattura del prodotto. I rocchetti realizzati con la tecnica del "rostrato" rifrangono e riflettono la luce che li colpisce creando un effetto scenografico molto suggestivo.

The discreet charm of soft, warm, enveloping light. A collection that alternates opaque and transparent volumes, in a dialogue of different crafting styles that bring out the fine workmanship of the product. Chunky crystal cylinders made with the "rostrato" technique reflect and refract the light with a dramatic effect.

Domo Amsterdam design Franco Raggi

Elegante scomposizione del lampadario classico. I bracci del lampadario Amsterdam, senza gravitare attorno al centro, si dispongono in orizzontale. L'elemento caratterizzante è il "rostrato", con le sue tipiche punte regolari. Disponibile in tre misure, ha l'altezza regolabile.

Elegant articulation of the classic chandelier. The arms of the Amsterdam chandelier, without gravitating around the center, are arranged horizontally. The characteristic element is the "rostrato" with its typical pointed elements. Available in three sizes, its height is adjustable.





Amsterdam 5562/14



Domo Amsterdam 7115

Modelli e misure
Models and sizes

*Per Amsterdam è prevista una catena di 100 cm inclusa.
Amsterdam is supplied with a 100 cm (39 1/4") chain.

	Amsterdam 5562-05	Amsterdam 5562-08	Amsterdam 5562-10	Amsterdam 5562-14
Peso Weight	18 kg 40 lb	22 kg 48 lb	26 kg 57 lb	31 kg 68 lb
Lampadine N. Tipo W max. Bulbs N. Type W max.	5 E14 60 E12 60	8 E14 60 E12 60	10 E14 60 E12 60	14 E14 60 E12 60
Dimmerabile Dimmable	D	D	D	D
Lampadine incluse Bulbs included				
Certificazioni Cerification Marks				

Modelli e misure
Models and sizes

*Per Amsterdam è prevista una catena di 100 cm inclusa.
Amsterdam is supplied with a 100 cm (39 1/4") chain.

	Domo Amsterdam 7114-16
Peso Weight	38 kg 85 lb
Lampadine N. Tipo W max. Bulbs N. Type W max.	16 E14 60 E12 60
Dimmerabile Dimmable	D
Lampadine incluse Bulbs included	
Certificazioni Cerification Marks	

Modelli e misure
Models and sizes

*Per Amsterdam è prevista una catena di 100 cm inclusa.
Amsterdam is supplied with a 100 cm (39 1/4") chain.

	Amsterdam 5562-18	Amsterdam 5562-24	Domo Amsterdam 7114-08	Domo Amsterdam 7114-12
Peso Weight	37 kg 81 lb	45 kg 99 lb	13 kg 28 lb	17 kg 37 lb
Lampadine N. Tipo W max. Bulbs N. Type W max.	18 E14 60 E12 60	24 E14 60 E12 60	8 E14 60 E12 60	12 E14 60 E12 60
Dimmerabile Dimmable	D	D	D	D
Lampadine incluse Bulbs included				
Certificazioni Cerification Marks				

Colori disponibili
Available colours

*Per Amsterdam la finitura abbinata al colore OO è sempre OG. Per Domo Amsterdam la finitura abbinata al colore OO può essere CL, CN o OF.
For Amsterdam the finishing matching colour OO is always OG. For Domo Amsterdam the finishings matching colour OO can be CL, CN or OF.

CC Cristallo Crystal	IC Grigio Grey	EK Sabbia Sand	DK Oliva Olive	AK Blu Cadetto Cadet Blue
LQ Bluastro Bluastro	FK Indaco Indigo	CK Pervinca Periwinkle	VI Viola Violet	*OO Oro Gold

Finiture
Finishings

CL Cromo Lucido Polished Chrome	*OG Oro Galvanizzato Galvanized Gold *Solo OO Amsterdam Only OO Amsterdam	*CN Cromo Nero Dark Chrome *Solo Domo Amsterdam Only Domo Amsterdam	*OF Ottone Spazzolato Fine Fine Brushed Brass *Solo Domo Amsterdam Only Domo Amsterdam

Paralumi
Shades

Esterno: Cotone
External: Cotton

BB Bianco White	NN Nero Black	NO Nero Interno Oro Black Inner Gold	

BABYLON

Una collezione di lampadari con paralume, composta da quattro modelli, il cui segno distintivo è l'altezza ridotta (57 cm per il modello più piccolo fino ad un massimo di 80 cm), particolarmente adatta per illuminare ambienti in cui l'altezza non consentirebbe l'utilizzo di un lampadario tradizionale. Il paralume è in tessuto plissettato.

A collection of chandeliers with lampshades, of four models, whose distinctive sign is the reduced height (22 1/2" for the smallest model up to a maximum of 31 1/2"), particularly suitable to illuminate rooms whose height would not allow the use of a traditional chandelier. The lampshades are made of pleated fabric.



Modelli e misure Models and sizes	Babylon 5599-08	Babylon 5599-16	Babylon 5599-24	Babylon 5599-30
*Ogni modello prevede una catena di 100 cm inclusa. Every model is supplied with a 100 cm (39 1/4") chain.				
Peso Weight	9 kg 20 lb	14 kg 31 lb	20 kg 44 lb	24 kg 53 lb
Lampadine N. Tipo W max. Bulbs N. Type W max.	8 E14 60 E12 60	16 E14 60 E12 60	24 E14 60 E12 60	30 E14 60 E12 60
Dimmerabile Dimmable	D	D	D	D
Lampadine incluse Bulbs included				
Certificazioni Certification Marks				

Colori disponibili Available colours



CC
Cristallo
Crystal



IC
Grigio
Grey



EK
Sabbia
Sand



DK
Oliva
Olive



AK
Blu Cadetto
Cadet Blue



LQ
Bluastro
Bluastro



FK
Indaco
Indigo



CK
Pervinca
Periwinkle



VI
Viola
Violet



***OO**
Oro
Gold
*Solo OG
Only OG

Finiture Finishings



CN
Cromo Nero
Dark Chrome



***OG**
Oro Galvanizzato
Galvanized Gold
*Solo OO
Only OO

Paralumi Shades

Nastro Pongè
Pongee Ribbon

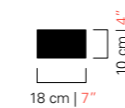

BB
Bianco
White



NN
Nero
Black

BAIKAL

Sulle orme di Taif, icona del design, Baikal ne riprende alcuni elementi distintivi come i pendagli in cristallo, i pastorali ritorti e i lunghi portalampade, ma con un corpo centrale più longilineo.

Following in the footsteps of Taif, a design icon, Baikal revisits some of its distinctive elements as the crystal pendants, the twisted pastorals and the long lamp holders, on a more tapered body.



Modelli e misure Models and sizes

*Ogni modello prevede una catena di 100 cm inclusa.
Every model is supplied with a 100 cm (39 1/4") chain.

	Baikal 5560-06	Baikal 5560-09	Baikal 5560-12	Baikal 5560-18
Peso Weight	18 kg 40 lb	27 kg 60 lb	35 kg 78 lb	64 kg 142 lb
Lampadine Bulbs	N. Tipo W max. 6 E14 60	N. Tipo W max. 9 E14 60	N. Tipo W max. 12 E14 60	N. Tipo W max. 18 E14 60
Dimmerabile Dimmable	D	D	D	D
Lampadine incluse Bulbs included				
Certificazioni Certification Marks				

Colori disponibili Available colours



CC
Cristallo
Crystal



BB
Bianco
White



IC
Grigio
Grey



EK
Sabbia
Sand



DK
Oliva
Olive



LQ
Bluastro
Bluastro



FK
Indaco
Indigo



CK
Pervinca
Periwinkle



***OO**
Oro
Gold
*Solo OG
Only OG



NN
Nero
Black

Finiture Finishings



CL
Cromo Lucido
Polished Chrome



***OG**
Oro Galvanizzato
Galvanized Gold
*Solo OO
Only OO

BISSA BOBA

Angelo Barovier

Angelo Barovier, ispirandosi ad un lampadario veneziano degli archivi di Barovier&Toso, nel 1992 inventa un lampadario scomposto fatto di bracci che, come un serpente incantato, si ergono e si allontanano sinuosamente dal centro. Da qui il nome: "Bissa" è la parola che usano i veneziani per indicare un serpente.

Angelo Barovier, inspired by a Venetian chandelier from the Barovier&Toso archives, invented a decomposed chandelier made of arms which, like an enchanted snake, rise and sinuously move away from the center. Hence the name: "Bissa" is the word that Venetians use to indicate a snake.



Modelli e misure Models and sizes

*Ogni modello prevede una catena di 100 cm inclusa.
Every model is supplied with a 100 cm (39 1/4") chain.

	Bissa Boba 6753-08	Bissa Boba 6753-12	Bissa Boba 6753-16	Bissa Boba 6753-20
Peso Weight	9 kg 20 lb	14 kg 31 lb	18 kg 40 lb	23 kg 51 lb
Lampadine Bulbs	N. Tipo W max. 8 E14 60	N. Tipo W max. 12 E14 60	N. Tipo W max. 16 E14 60	N. Tipo W max. 20 E14 60
Dimmerabile Dimmable	D	D	D	D
Lampadine incluse Bulbs included				
Certificazioni Certification Marks				

Colori disponibili Available colours



CC
Cristallo
Crystal



IC
Grigio
Grey



EK
Sabbia
Sand



DK
Oliva
Olive



AK
Blu Cadetto
Cadet Blue



LQ
Bluastro
Bluastro



FK
Indaco
Indigo



CK
Pervinca
Periwinkle



VI
Viola
Violet



***OO**
Oro
Gold
*Solo OO
Only OO

Finiture Finishings



CL
Cromo Lucido
Polished Chrome



***OG**
Oro Galvanizzato
Galvanized Gold
*Solo OO
Only OO

DEGAS

Lampadari leggeri ed allungati dal disegno raffinato ed elegante. Spogliati delle tradizionali decorazioni floreali lasciano esposti i delicati bracci e rendono protagonista la luce soffusa donando calore ed atmosfera agli ambienti.

Graceful chandeliers that extend outward in a refined, elegant design. Stripped of the traditional floral decorations, their delicate arms are exposed, making the soft glow become the main feature that adds warmth and atmosphere to spaces.



Modelli e misure Models and sizes

*Ogni modello prevede una catena di 100 cm inclusa.
Every model is supplied with a 100 cm (39 1/4") chain.

	Degas 5554-06	Degas 5554-09	Degas 5554-12	Degas 5554-18
Peso Weight	9 kg 20 lb	10 kg 22 lb	16 kg 36 lb	24 kg 53 lb
Lampadine Bulbs	N. Tipo W max. 6 E14 60	N. Tipo W max. 9 E14 60	N. Tipo W max. 12 E14 60	N. Tipo W max. 18 E14 60
Dimmerabile Dimmable	D	D	D	D
Lampadine incluse Bulbs included				
Certificazioni Certification Marks				

Colori disponibili Available colours



CC
Cristallo
Crystal



IC
Grigio
Grey



EK
Sabbia
Sand



DK
Oliva
Olive



AK
Blu Cadetto
Cadet Blue



LQ
Bluastro
Bluastro



FK
Indaco
Indigo



CK
Pervinca
Periwinkle



VI
Viola
Violet



***OO**
Oro
Gold
*Solo OO
Only OO

Finiture Finishings



CL
Cromo Lucido
Polished Chrome



***OG**
Oro Galvanizzato
Galvanized Gold
*Solo OO
Only OO

DHAMAR

I pinnacoli in colore "affogato" nel cristallo slanciano questo lampadario dalla struttura allargata e, insieme ai particolari pendagli e alle sfere sfaccettate, ne fanno un elemento decorativo importante.

Their colour "sunk" into the crystal pinnacles confer a graceful, slender look to this family of high-profile chandeliers. Meanwhile, the very unusual shapes of the pendants, complemented by the multifaceted spheres, conjure a compelling decorative effect.



Modelli e misure Models and sizes

*Ogni modello prevede una catena di 100 cm inclusa.
Every model is supplied with a 100 cm (39 1/4") chain.

	Dhamar 5596-06	Dhamar 5596-09	Dhamar 5596-12
Peso Weight	20 kg 44 lb	27 kg 59 lb	32 kg 70 lb
Lampadine Bulbs	N. Tipo W max. 6 E14 60	N. Tipo W max. 9 E14 60	N. Tipo W max. 12 E14 60
Dimmerabile Dimmable	D	D	D
Lampadine incluse Bulbs included			
Certificazioni Certification Marks			

Colori disponibili Available colours



CC
Cristallo
Crystal



BB
Bianco
White



IC
Grigio
Grey



EK
Sabbia
Sand



DK
Oliva
Olive



LQ
Bluastro
Bluastro



FK
Indaco
Indigo



CK
Pervinca
Periwinkle



***OO**
Oro
Gold
*Solo OO
Only OO



NN
Nero
Black

Finiture Finishings



CL
Cromo Lucido
Polished Chrome



***OG**
Oro Galvanizzato
Galvanized Gold
*Solo OO
Only OO

FAUVE

Elementi caratterizzanti di questa collezione sono le foglie sottili ed allungate sapientemente lavorate dai maestri vetrai nelle nostre fornaci. Oggetti dal design pulito che si inseriscono facilmente nei contesti più variegati riuscendo ad impreziosire un angolo o una stanza.

The characteristic features of this collection are the thin extending leaves created by master craftsmen in our furnaces. Objects with a clean design, to easily insert in a wide range of contexts, enhancing a corner or an entire room.



Modelli e misure Models and sizes

*Ogni modello prevede una catena di 100 cm inclusa.
Every model is supplied with a 100 cm (39 1/4") chain.

	Fauve 5306-06	Fauve 5306-08	Fauve 5306-12
Peso Weight	8 kg 18 lb	9 kg 20 lb	15 kg 33 lb
Lampadine Bulbs	N. Tipo W max. 6 E14 60	N. Tipo W max. 8 E14 60	N. Tipo W max. 12 E14 60
Dimmerabile Dimmable	D	D	D
Lampadine incluse Bulbs included			
Certificazioni Certification Marks			

Colori disponibili Available colours



CC
Cristallo
Crystal



IC
Grigio
Grey



EK
Sabbia
Sand



DK
Oliva
Olive



AK
Blu Cadetto
Cadet Blue



LQ
Bluastro
Bluastro



FK
Indaco
Indigo

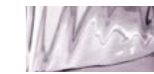

CK
Pervinca
Periwinkle



VI
Viola
Violet



***OO**
Oro
Gold
*Solo OO
Only OO

Finiture Finishings



CL
Cromo Lucido
Polished Chrome



***OG**
Oro Galvanizzato
Galvanized Gold
*Solo OO
Only OO

FEZ

Le foglie dorate e i pendagli a oliva caratterizzano questa famiglia di lampadari dalle altezze ridotte, ideali per i soffitti delle case moderne ma perfetti anche per i palazzi più lussuosi.

Gilded leaves and olive pendants feature in this family of chandeliers with reduced heights, ideal for the ceilings of modern houses but also perfect for more luxurious buildings.



Modelli e misure Models and sizes	Fez 5602-06	Fez 5602-08	Fez 5602-12	Fez 5602-18
*Ogni modello prevede una catena di 100 cm inclusa. Every model is supplied with a 100 cm (39 1/4") chain.				
Peso Weight	9 kg 20 lb	15 kg 33 lb	22 kg 49 lb	36 kg 80 lb
Lampadine N. Tipo W.max. Bulbs N. Type W.max.	6 E14 60 E12 60	8 E14 60 E12 60	12 E14 60 E12 60	18 E14 60 E12 60
Dimmerabile Dimmable	D	D	D	D
Lampadine incluse Bulbs included				
Certificazioni Certification Marks				

Colori disponibili Available colours



CC
Cristallo
Crystal



IC
Grigio
Grey



EK
Sabbia
Sand



DK
Oliva
Olive



AK
Blu Cadetto
Cadet Blue



LQ
Bluastro
Bluastro



FK
Indaco
Indigo



CK
Perivinka
Periwinkle



VI
Viola
Violet



***OO**
Oro
Gold
*Solo OG
Only OG

Finiture Finishings



CL
Cromo Lucido
Polished Chrome



***OG**
Oro Galvanizzato
Galvanized Gold
*Solo OO
Only OO

FLORIAN

I nostri archivi storici sono una miniera di ispirazioni: proprio da qui nasce Florian, un lampadario non circolare dalle linee retrò eppure così moderne, accentuate dai massicci paralumi in cristallo veneziano eseguiti con la tecnica del "rostrato", invenzione di Ercole Barovier che moltiplica i bagliori di luce e rende il lampadario un'opera di maestria unica.

Our historic archives provide a wealth of inspiration, and it was through them that the Florian design, a non-circular chandelier, was conceived. The lines of Florian are so retro but at the same time so contemporary, accentuated by massive Venetian crystal lampshades created using the "rostrato" technique invented by Ercole Barovier, intensifying the sparkle of the lights and making this chandelier a unique piece of craftsmanship.



Modelli e misure Models and sizes

*Ogni modello prevede una catena di 100 cm inclusa.
Every model is supplied with a 100 cm (39 1/4") chain.

	Florian 5717-04	Florian 5717-06	Florian 5717-08	Florian 5717-10
Peso Weight	16 kg 35 lb	24 kg 53 lb	30 kg 66 lb	39 kg 86 lb
Lampadine N. Tipo W max. Bulbs N. Type W max.	4 E14 60 E12 60	6 E14 60 E12 60	8 E14 60 E12 60	10 E14 60 E12 60
Dimmerabile Dimmable	D	D	D	D
Lampadine incluse Bulbs included				
Certificazioni Certification Marks				

Colori disponibili Available colours



CC
Cristallo
Crystal

Finiture Finishings



CL
Cromo Lucido
Polished Chrome



CN
Cromo Nero
Dark Chrome



OF
Ottone
Spazzolato Fine
Fine Brushed Brass

IZMIR

Forme sinuose, pendagli in cristallo trasparente e bracci in cristallo veneziano ritorto: una combinazione ideale per esaltare la lucentezza e la matericità del vetro.

Sinuous forms, pendants in transparent crystal and arms in twisted Venetian crystal: an ideal combination to embellish the brilliance and substance of the glass.



Modelli e misure Models and sizes

*Ogni modello prevede una catena di 100 cm inclusa.
Every model is supplied with a 100 cm (39 1/4") chain.

	Izmir 5555-08	Izmir 5555-12	Izmir 5555-18	Izmir 5555-24
Peso Weight	18 kg 40 lb	28 kg 62 lb	40 kg 88 lb	52 kg 114 lb
Lampadine N. Tipo W max. Bulbs N. Type W max.	8 E14 60 E12 60	12 E14 60 E12 60	18 E14 60 E12 60	24 E14 60 E12 60
Dimmerabile Dimmable	D	D	D	D
Lampadine incluse Bulbs included				
Certificazioni Certification Marks				

Colori disponibili Available colours



CC
Cristallo
Crystal



IC
Grigio
Grey



EK
Sabbia
Sand



DK
Oliva
Olive



AK
Blu Cadetto
Cadet Blue



LQ
Bluastro
Bluastro



FK
Indaco
Indigo



CK
Perivinka
Periwinkle



VI
Viola
Violet



***OO**
Oro
Gold
*Solo OG
Only OG

Finiture Finishings



CL
Cromo Lucido
Polished Chrome





***OG**
Oro Galvanizzato
Galvanized Gold
*Solo OO
Only OO



MAGRITTE

La collezione Magritte è frutto di un lavoro concettuale che indaga l'idea di lampadario fino a ripensarla e destrutturarla. Ispirata al linguaggio surrealista, si presenta con un impianto scenografico ed elegante, a più livelli, come vuole la tradizione, ma nella realtà rivela un nuovo ed avanguardistico design. Il classico nucleo centrale a bracci lascia spazio ad un sistema a satelliti modulari, concepito per essere esteso in modo concentrico, come una nuvola di luce e vetro soffiato.

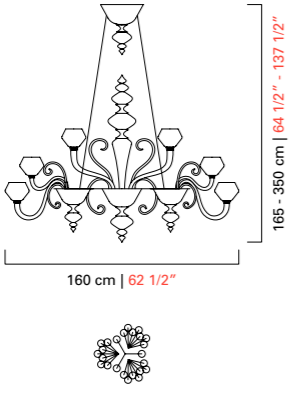
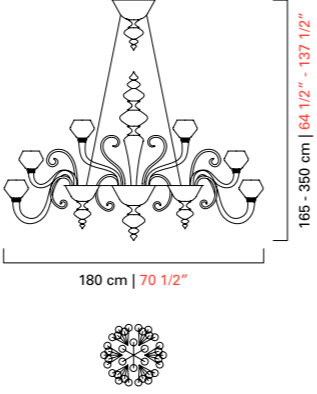
The Magritte collection is the result of a conceptual work that investigates the idea of a chandelier to the point of rethinking and deconstructing it. Inspired by the surrealist language, presents itself with a scenographic and elegant layout, on multiple levels, as tradition dictates, but in reality it reveals a new and avant-garde design. The classic central core with arms leaves room for a modular satellite system, conceived to be extended concentrically, like a cloud of light and blown glass.

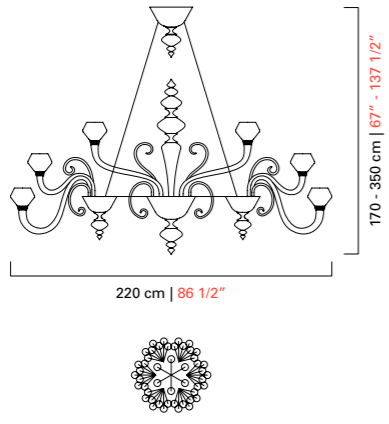

Modelli e misure <i>Models and sizes</i>		Magritte 5721-24	Magritte 5721-36
			
Peso Weight		55 kg 121 lb	80 kg 176 lb
Lampadine N. Tipo W max. Bulbs N. Type W max.		24 E14 60 E12 60	36 E14 60 E12 60
Dimmerabile Dimmable		D	D
Lampadine incluse Bulbs included			
Certificazioni Cerification Marks			

Modelli e misure <i>Models and sizes</i>		Magritte 5721-48
		
Peso Weight		110 kg 242 lb
Lampadine N. Tipo W max. Bulbs N. Type W max.		48 E14 60 E12 60
Dimmerabile Dimmable		D
Lampadine incluse Bulbs included		
Certificazioni Cerification Marks		

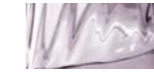
Colori disponibili
Available colours**CC**
Cristallo
Crystal**IC**
Grigio
Grey**EK**
Sabbia
Sand**DK**
Oliva
Olive**AK**
Blu Cadetto
Cadet Blue**LQ**
Bluastro
Bluastro**FK**
Indaco
Indigo**CK**
Pervinca
Periwinkle**VI**
Viola
Violet***OO**
Oro
Gold
*Solo OG
*Only OG***Finiture**
Finishings**CL**
Cromo Lucido
Polished Chrome***OG**
Oro Galvanizzato
Galvanized Gold
*Solo OO
Only OO

MARYLAND

I bracci molto sinuosi, il pendaglio a goccia, i paralumi eleganti: la collezione Maryland riporta il pensiero agli eleganti palazzi neoclassici del Nuovo Continente, dove imponenti lampadari fanno bella mostra di sé nelle stanze più importanti.

Sleek curves for the arms, drop pendants and elegant shades: Maryland collection recalls of Neoclassical buildings of the New World where majestic chandeliers are showcased in the most important rooms.



Modelli e misure
Models and sizes

*Ogni modello prevede una catena di 100 cm inclusa.
Every model is supplied with a 100 cm (39 1/4") chain.

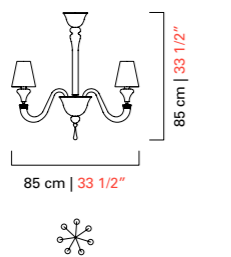
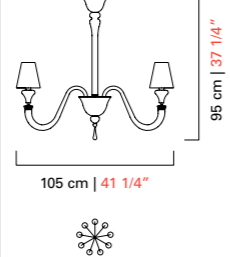
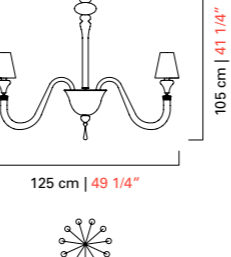
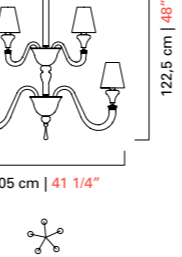
	Maryland 5587-07	Maryland 5587-09	Maryland 5587-11	Maryland 5587-14
				
Peso Weight	8 kg 18 lb	12 kg 26 lb	15 kg 33 lb	19 kg 42 lb
Lampadine N. Tipo W max. Bulbs N. Type W max.	7 E14 60 E12 60	9 E14 60 E12 60	11 E14 60 E12 60	14 E14 60 E12 60
Dimmerabile Dimmable	D	D	D	D
Lampadine incluse Bulbs included				
Certificazioni Cerification Marks				

Modelli e misure
Models and sizes

*Ogni modello prevede una catena di 100 cm inclusa.
Every model is supplied with a 100 cm (39 1/4") chain.

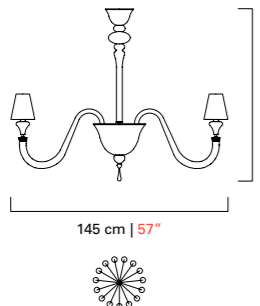
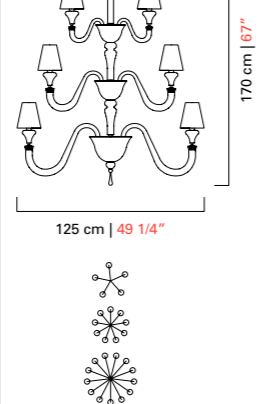
	Maryland 5587-15	Maryland 5587-27
		
Peso Weight	21 kg 46 lb	34 kg 75 lb
Lampadine N. Tipo W max. Bulbs N. Type W max.	15 E14 60 E12 60	27 E14 60 E12 60
Dimmerabile Dimmable	D	D
Lampadine incluse Bulbs included		
Certificazioni Cerification Marks		

Colori disponibili
Available colours



 CC Cristallo <i>Crystal</i>	 IC Grigio <i>Grey</i>	 EK Sabbia <i>Sand</i>	 DK Oliva <i>Olive</i>	 AK Blu Cadetto <i>Cadet Blue</i>
 LQ Bluastro <i>Bluastro</i>	 FK Indaco <i>Indigo</i>	 CK Pervinca <i>Periwinkle</i>	 VI Viola <i>Violet</i>	 *OO Oro <i>Gold</i> *Solo OG <i>Only OG</i>

Finiture
Finishings

 CL Cromo Lucido <i>Polished Chrome</i>	 *OG Oro Galvanizzato <i>Galvanized Gold</i> *Solo OO <i>Only OO</i>
--	---

Paralumi
Shades

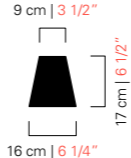
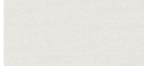
Esterno: Cotone
External: Cotton

 16 cm 6 1/4\" data-bbox="610 450 655 460"/>	 BB Bianco <i>White</i>	 NN Nero <i>Black</i>	 NO Nero Interno Oro <i>Black Inner Gold</i>
--	--	--	---

MEKNES

Dall'archivio dei disegni storici di Barovier&Toso un lampadario della tradizione veneziana, ricco di elementi decorativi ispirati al mondo naturale. Fiori, foglie e boccioli fatti a mano rendono questo oggetto estremamente ricco e prezioso.

From the historical drawings archive of Barovier&Toso a chandelier from the Venetian tradition, full of decorative elements inspired by nature. Hand crafted flowers, leaves and buds make this object extremely rich and precious.



Modelli e misure Models and sizes

*Ogni modello prevede una catena di 100 cm inclusa.
Every model is supplied with a 100 cm (39 1/4") chain.

	Meknes 4797-06	Meknes 4797-08	Meknes 4797-12	Meknes 4797-18
Peso Weight	7 kg 15 lb	15 kg 33 lb	23 kg 51 lb	30 kg 66 lb
Lampadine Bulbs	N. Tipo W max. 6 E14 60	N. Tipo W max. 8 E14 60	N. Tipo W max. 12 E14 60	N. Tipo W max. 18 E14 60
Dimmerabile Dimmable	D	D	D	D
Lampadine incluse Bulbs included				
Certificazioni Certification Marks				

Colori disponibili Available colours



CC
Cristallo
Crystal



CU
Cristallo/
Decoro Bluastro
Crystal/ Bluastro
Decoration



DO
Cristallo/
Decoro Oro
Crystal/ Gold
Decoration



***OO**
Oro
Gold
*Solo OO
Only OO

Finiture Finishings



CL
Cromo Lucido
Polished Chrome



***OG**
Oro Galvanizzato
Galvanized Gold
*Solo OO
Only OO

METROPOLIS

Metropolis si ispira alle atmosfere glamour ed ammalianti degli anni '20, capaci di rievocare quel vivace fermento che investì le arti visive, il design, l'architettura e la moda dell'epoca. Attingendo a quelle vibranti tendenze estetiche, che videro New York, Mosca, Berlino e Parigi trasformarsi in capitali del lusso, del divertimento e della bella vita. Una nuova collezione affascinante e raffinata, carica di una tensione espressiva intensa e sensuale.

Metropolis takes its cue from the glamorous, seductive atmospheres of the 1920s, drawing on the lively ferment in the visual arts, design, architecture and fashion in that period. Referencing the vibrant aesthetic trends that made New York, Moscow, Berlin and Paris into worldwide capitals of luxury, entertainment and lifestyle. A new collection fascinating and refined, charged with intense and sensual expressive energy.



Modelli e misure
Models and sizes

*Ogni modello prevede una catena di 100 cm inclusa.
 Every model is supplied with a 100 cm (39 1/4") chain.

	Metropolis 5720-06	Metropolis 5720-09	Metropolis 5720-12	Metropolis 5720-18
Peso Weight	15 kg 33 lb	18 kg 40 lb	25 kg 55 lb	37 kg 82 lb
Lampadine N. Tipo W max. Bulbs N. Type W max.	6+3 G9+Led 7+1,5 7+1,5	9+3 G9+Led 7+1,5 7+1,5	12+3 G9+Led 7+1,5 7+1,5	18+4 G9+Led 7+1,5 7+1,5
Dimmerabile Dimmable	D G9	D G9	D G9	D G9
Lampadine incluse Bulbs included	G9 Led + Led	G9 Led + Led	G9 Led + Led	G9 Led + Led
Certificazioni Certification Marks				

Colori disponibili
Available colours

CC
Cristallo
Crystal



IC
Grigio
Grey



EK
Sabbia
Sand



DK
Oliva
Olive



AK
Blu Cadetto
Cadet Blue



LQ
Bluastro
Bluastro



FK
Indaco
Indigo



CK
Pervinca
Periwinkle



VI
Viola
Violet



OO
Oro
Gold

Finiture
Finishings

NJ
Nickel Nero
Spazzolato
Brushed Black
Nickel



OJ
Oro Spazzolato
Brushed Gold

NEVADA

Arredare con un lampadario in cristallo veneziano di questa collezione significa donare eleganza e carattere agli ambienti, anche se di stili differenti. L'elemento caratterizzante sono i bracci rettilinei quasi privi di curvature dai quali pendono esili e delicati pendagli a forma di goccia.

Decorating with a chandelier in Venetian crystal from this collection means adding elegance and character to spaces, even when their styles differ. The rectilinear arms, almost without curvature, are the characteristic feature, supporting slender, delicate dewdrop pendants.



Modelli e misure
Models and sizes

*Ogni modello prevede una catena di 100 cm inclusa.
Every model is supplied with a 100 cm (39 1/4") chain.

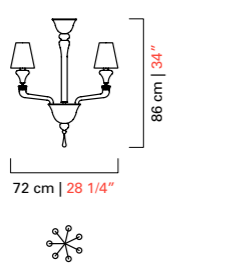
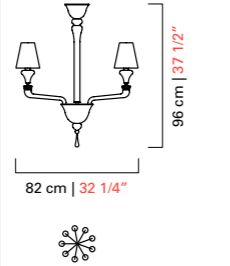
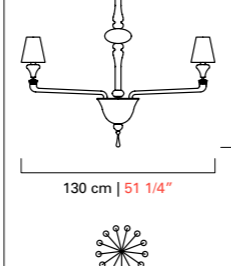
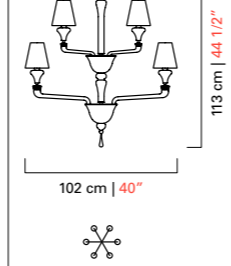
	Nevada 5549-07	Nevada 5549-09	Nevada 5549-13	Nevada 5549-15
				
Peso Weight	9 kg 20 lb	12 kg 26 lb	20 kg 44 lb	19 kg 42 lb
Lampadine N. Tipo W max. Bulbs N. Type W max.	7 E14 60 E12 60	9 E14 60 E12 60	13 E14 60 E12 60	15 E14 60 E12 60
Dimmerabile Dimmable	D	D	D	D
Lampadine incluse Bulbs included				
Certificazioni Cerification Marks				

Modelli e misure
Models and sizes

*Ogni modello prevede una catena di 100 cm inclusa.
Every model is supplied with a 100 cm (39 1/4") chain.

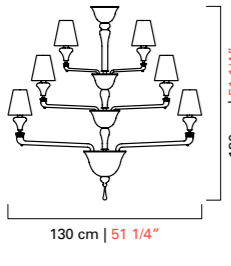
	Nevada 5549-24
	
Peso Weight	30 kg 66 lb
Lampadine N. Tipo W max. Bulbs N. Type W max.	24 E14 60 E12 60
Dimmerabile Dimmable	D
Lampadine incluse Bulbs included	
Certificazioni Cerification Marks	

Colori disponibili
Available colours



 CC Cristallo Crystal	 IC Grigio Grey	 EK Sabbia Sand	 DK Oliva Olive	 AK Blu Cadetto Cadet Blue
 LQ Bluastro Bluastro	 FK Indaco Indigo	 CK Pervinca Perwinkle	 VI Viola Violet	 *OO Oro Gold *Solo OG Only OG

Finiture
Finishings

 CL Cromo Lucido Polished Chrome	 *OG Oro Galvanizzato Galvanized Gold *Solo OO Only OO
---	---

Paralumi
Shades

Esterno: Cotone
External: Cotton

 BB Bianco White	 NN Nero Black	 NO Nero Interno Oro Black Inner Gold
---	---	--

ODILE





Lampadari in cristallo veneziano realizzati a mano dai nostri esperti maestri vetrai. Queste raffinate creazioni donano eleganza e classe ad ogni tipo di ambiente, sia classico che moderno, rappresentano l'ornamento di lusso che abbina la tradizione antica al design più moderno: vere opere d'arte per illuminare al meglio gli spazi.

Chandeliers in Venetian crystal handcrafted by our expert master glassmakers. These refined creations add elegance and class to any decor, classic or modern. They represent an approach to luxury that combines an age-old tradition with the most advanced design: true works of art to brighten all kinds of spaces.

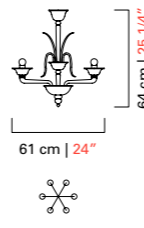
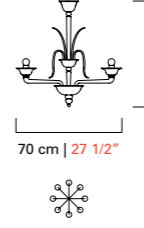
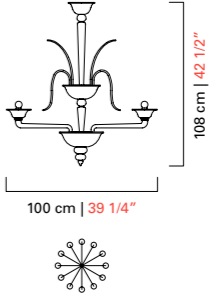

Modelli e misure Models and sizes

*Ogni modello prevede una catena di 100 cm inclusa.
Every model is supplied with a 100 cm (39 1/4") chain.

	Odile 5307-06	Odile 5307-08	Odile 5307-12
			
Peso Weight	7 kg 15 lb	8 kg 18 lb	13 kg 29 lb
Lampadine Bulbs	N. Tipo W max. 6 E14 60	N. Tipo W max. 8 E14 60	N. Tipo W max. 12 E14 60
Dimmerabile Dimmable	D	D	D
Lampadine incluse Bulbs included			
Certificazioni Certification Marks			

Colori disponibili Available colours



CC
Cristallo
Crystal



IC
Grigio
Grey



EK
Sabbia
Sand



DK
Oliva
Olive



AK
Blu Cadetto
Cadet Blue



LQ
Bluastro
Bluastro



FK
Indaco
Indigo



CK
Pervinca
Perwinkle



VI
Viola
Violet



***OO**
Oro
Gold
*Solo OG
Only OG

Finiture Finishings



CL
Cromo Lucido
Polished Chrome



***OG**
Oro Galvanizzato
Galvanized Gold
*Solo OO
Only OO

PALLADIANO

Simmetria, ordine, perfezione ed eleganza sono le muse ispiratrici di questa collezione. Un omaggio alla razionalità e all'equilibrio delle opere del Palladio ed ai valori dell'architettura formale classica. Anche la scelta della palette cromatica con i suoi colori pieni, non trasparenti, è una celebrazione della matericità e del volume dell'oggetto che si trasforma quasi, esso stesso, in una piccola architettura.

Symmetry, order, perfection and elegance are the muses behind this collection. A tribute to the rationality and balance of the works of Palladio, and the values of formal classical architecture. The selection of colours, in full, non-transparent hues, is a celebration of the material and volume of the object, which is transformed almost into a small work of architecture.

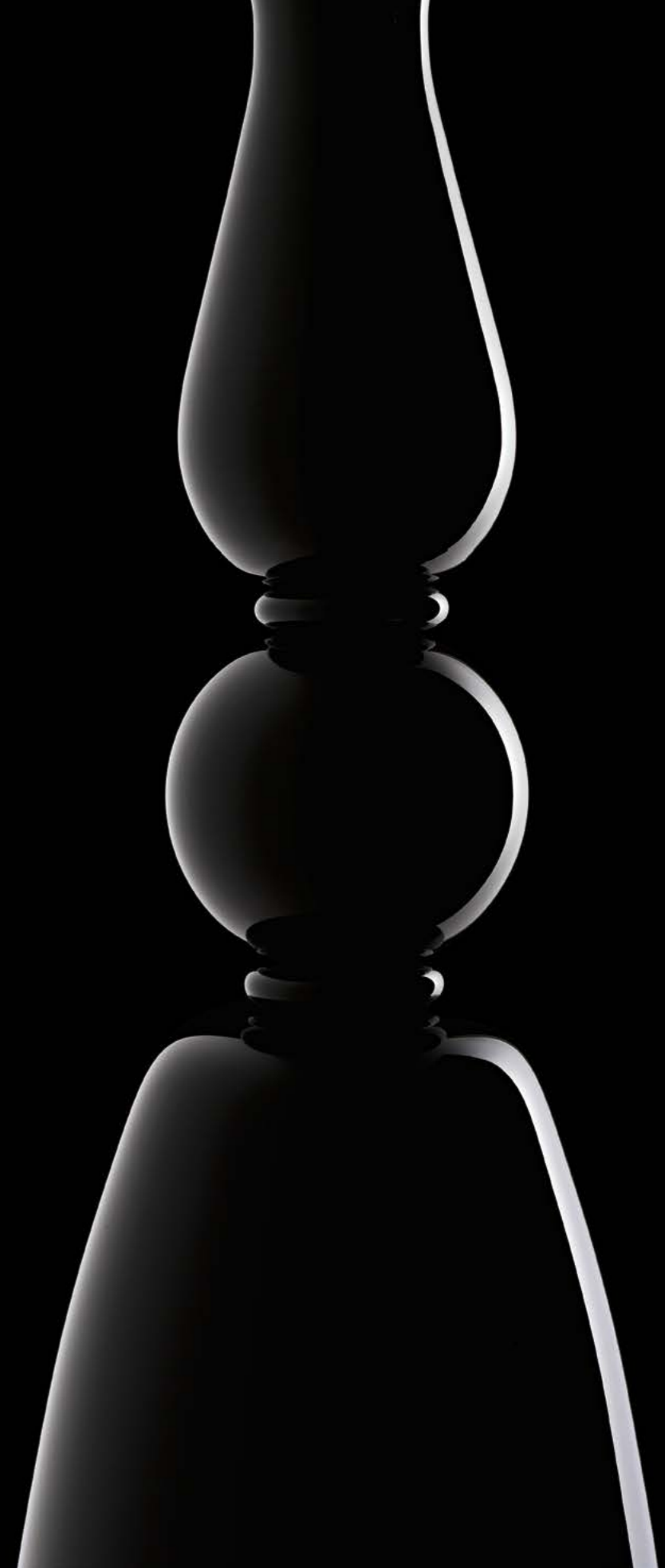

Modelli e misure
Models and sizes

*Ogni modello prevede una catena di 100 cm inclusa.
 Every model is supplied with a 100 cm (39 1/4") chain.

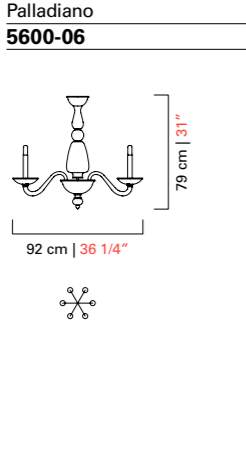
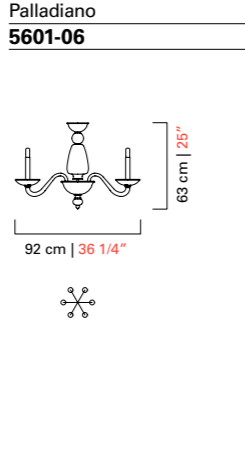
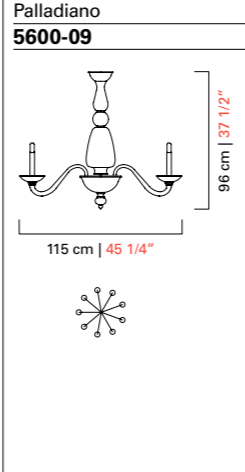
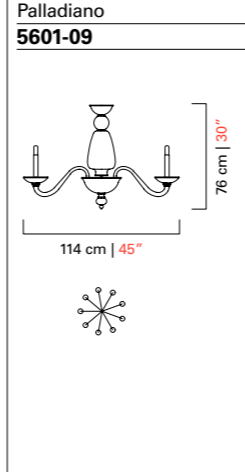
	Palladiano 5600-06	Palladiano 5601-06	Palladiano 5600-09	Palladiano 5601-09
				
Peso Weight	12 kg 26 lb	11 kg 24 lb	16 kg 35 lb	15 kg 33 lb
Lampadine N. Tipo W max. Bulbs N. Type W max.	6 E14 60 E12 60	6 E14 60 E12 60	9 E14 60 E12 60	9 E14 60 E12 60
Dimmerabile Dimmable	D	D	D	D
Lampadine incluse Bulbs included				
Certificazioni Cerification Marks				

Colori disponibili
Available colours

CC
Cristallo
Crystal



BB
Bianco
White



NN
Nero
Black

Finiture
Finishings

CL
Cromo Lucido
Polished Chrome

Modelli e misure
Models and sizes

*Ogni modello prevede una catena di 100 cm inclusa.
 Every model is supplied with a 100 cm (39 1/4") chain.

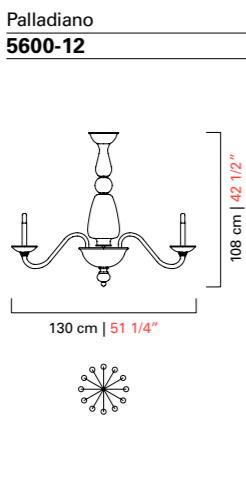
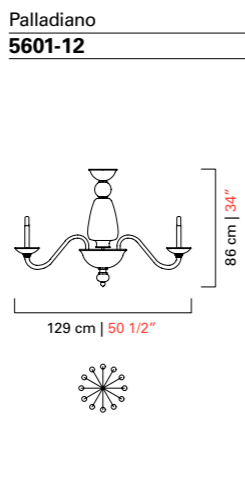
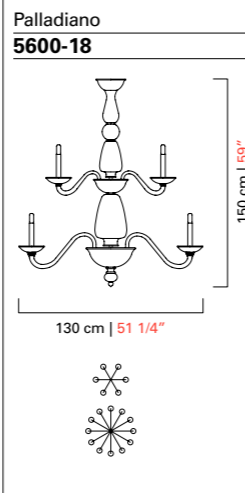
	Palladiano 5600-12	Palladiano 5601-12	Palladiano 5600-18
			
Peso Weight	20 kg 44 lb	18 kg 40 lb	30 kg 66 lb
Lampadine N. Tipo W max. Bulbs N. Type W max.	12 E14 60 E12 60	12 E14 60 E12 60	18 E14 60 E12 60
Dimmerabile Dimmable	D	D	D
Lampadine incluse Bulbs included			
Certificazioni Cerification Marks			

PIGALLE

Tradizione ed innovazione si fondono in questa collezione ispirata alla Belle Époque. Si caratterizza per eleganza e linee sinuose senza risultare eccessiva ed ostentata. Eloquente per raffinatezza e grazia alterna linee semplici, dettagli curvi e lavorazioni tradizionali. I quattro lampadari che compongono la famiglia sono caratterizzati da un corpo centrale molto ricco, con elementi dalle forme morbide e sinuose lavorati con tecniche diverse. È circondato da bracci slanciati su cui poggiano i diffusori bianchi.

Tradition and innovation blend in this collection inspired by the Belle Époque. It stands out for its elegant, sinuous lines, without ever seeming excessive or ostentatious. With its eloquent refinement and grace, it mixes simple lines, curved details and traditional workmanship. A family of four chandeliers characterized by a lavish central body with soft-shape elements that are wrought using different techniques. It is surrounded by slender arms upon which the white diffusers rest.



Modelli e misure Models and sizes

*Ogni modello prevede una catena di 100 cm inclusa.
Every model is supplied with a 100 cm (39 1/4") chain.

	Pigalle 5680-06	Pigalle 5680-09	Pigalle 5680-12	Pigalle 5680-18
	75 cm 29 1/2"	100 cm 39 1/4"	120 cm 47 1/4"	120 cm 47 1/4"
Peso Weight	18 kg 40 lb	28 kg 62 lb	38 kg 84 lb	50 kg 110 lb
Lampadine N. Tipo W max. Bulbs N. Type W max.	6+1 Led 8,4+8,4 8,4+8,4	9+1 Led 8,4+8,4 8,4+8,4	12+1 Led 8,4+8,4 8,4+8,4	18+1 Led 8,4+8,4 8,4+8,4
Dimmerabile Dimmable				
Lampadine incluse Bulbs included	Led	Led	Led	Led
Certificazioni Certification Marks				

Colori disponibili Available colours



BC
Bianco/ Cristallo
White/ Crystal



OY
Oro Beige/ Oro
Gold Beige/ Gold

Finiture Finishings



CL
Cromo Lucido
Polished Chrome



CN
Cromo Nero
Dark Chrome



OJ
Oro Spazzolato
Brushed Gold

PREMIÈRE DAME

L'opulenza delle forme e dei dettagli rifugge nei pendagli di una collezione maestosa, degna delle più importanti, sontuose e ricercate dimore francesi. Con una ricchezza decorativa molto sofisticata, questa collezione si caratterizza per le diverse lavorazioni del cristallo veneziano e dei pendagli di fattura originale.

The opulence of shapes and details radiates in the pendants of a majestic collection, worthy of the most important, sumptuous and refined French residences. With its richly decorated and sophisticated design this collection is characterized by different Venetian crystal craftworks and an original pendants fabrication.



Modelli e misure Models and sizes

*Ogni modello prevede una catena di 100 cm inclusa.
Every model is supplied with a 100 cm (39 1/4") chain.

	Première Dame 5694-12	Première Dame 5696-12	Première Dame 5696-16	Première Dame 5696-24
Peso Weight	17 kg 37 lb	19 kg 42 lb	25 kg 55 lb	38 kg 84 lb
Lampadine N. Tipo W max. Bulbs N. Type W max.	12 E14 60 E12 60	12 E14 60 E12 60	16 E14 60 E12 60	24 E14 60 E12 60
Dimmerabile Dimmable	D	D	D	D
Lampadine incluse Bulbs included				
Certificazioni Certification Marks				

Colori disponibili Available colours



CC
Cristallo
Crystal



BB
Bianco
White



IC
Grigio
Grey



EK
Sabbia
Sand



DK
Oliva
Olive



LQ
Bluastro
Bluastro



FK
Indaco
Indigo



CK
Perwinka
Perwinkle



***OO**
Oro
Gold
*Solo OG
Only OG



NN
Nero
Black

Finiture Finishings



CL
Cromo Lucido
Polished Chrome



***OG**
Oro Galvanizzato
Galvanized Gold
*Solo OO
Only OO

Paralumi Shades

Nastro Pongè
Pongee Ribbon

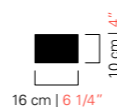

BB
Bianco
White



NN
Nero
Black

PRÉSIDENT

Un lampadario a bracci iconico per antonomasia che mette in risalto la meticolosa eleganza della lavorazione artigianale. Prismi cesellati, pendenti scintillanti e coppette decorate lo rendono un elemento d'arredo davvero unico in cui il cristallo veneziano rivela il suo splendore scultoreo.

An iconic chandelier with arms par excellence that proudly displays its painstaking workmanship and elegance. Chiseled prisms, sparkling pendants and decorated cups make this a truly unique decor feature, in which Venetian crystal reveals its sculptural splendour.



Modelli e misure
Models and sizes

*Ogni modello prevede una catena di 100 cm inclusa.
Every model is supplied with a 100 cm (39 1/4") chain.

	Président 5695-12	Président 5695-14	Président 5695-18	Président 5687-18
Peso Weight	17 kg 37 lb	24 kg 53 lb	29 kg 64 lb	34 kg 75 lb
Lampadine N. Tipo W max. Bulbs N. Type W max.	12 E14 60 E12 60	14 E14 60 E12 60	18 E14 60 E12 60	18 E14 60 E12 60
Dimmerabile Dimmable	D	D	D	D
Lampadine incluse Bulbs included				
Certificazioni Cerification Marks				

Modelli e misure
Models and sizes

*Ogni modello prevede una catena di 100 cm inclusa.
Every model is supplied with a 100 cm (39 1/4") chain.

	Président 5695-24	Président 5695-36
Peso Weight	42 kg 92 lb	45 kg 99 lb
Lampadine N. Tipo W max. Bulbs N. Type W max.	24 E14 60 E12 60	36 E14 60 E12 60
Dimmerabile Dimmable	D	D
Lampadine incluse Bulbs included		
Certificazioni Cerification Marks		

Colori disponibili
Available colours

CC Cristallo <i>Crystal</i>	BB Bianco <i>White</i>	IC Grigio <i>Grey</i>	EK Sabbia <i>Sand</i>	DK Oliva <i>Olive</i>
LQ Bluastro <i>Bluastro</i>	FK Indaco <i>Indigo</i>	CK Pervinca <i>Perwinkle</i>	*OO Oro <i>Gold</i> *Solo OG <i>Only OG</i>	NN Nero <i>Black</i>

Finiture
Finishings

CL Cromo Lucido <i>Polished Chrome</i>	*OG Oro Galvanizzato <i>Galvanized Gold</i> *Solo OO <i>Only OO</i>

Paralumi
Shades

Esterno: Cotone
External: Cotton

	BB Bianco <i>White</i>	NN Nero <i>Black</i>	NO Nero Interno Oro <i>Black Inner Gold</i>

RABAT

Una collezione classica, che utilizza molti degli stili della tradizione veneziana. In particolare, le "morise", decorazioni ondulate eseguite applicando a caldo un cordoncino di vetro pizzicato con le "borselle" (pinze) da "pissegar" (pizzicare) che consentono di ottenere una superficie che sembra un merletto.

A classical collection that features many of the stylistic elements of the Venetian tradition. In particular the "morise", wavy decorations executed by applying a hot crystal ribbon and then pinching it with the "borselle" (pincers) to "pissegar" (pinching) to obtain a texture that looks like a lace.



Modelli e misure Models and sizes

*Ogni modello prevede una catena di 100 cm inclusa.
Every model is supplied with a 100 cm (39 1/4") chain.

	Rabat 4513-05	Rabat 4513-08	Rabat 4513-12
Peso Weight	7 kg 15 lb	15 kg 33 lb	20 kg 44 lb
Lampadine Bulbs	N. Tipo W max. 5 E14 60 E12 60	N. Tipo W max. 8 E14 60 E12 60	N. Tipo W max. 12 E14 60 E12 60
Dimmerabile Dimmable	D	D	D
Lampadine incluse Bulbs included			
Certificazioni Certification Marks			

Colori disponibili Available colours



CC
Cristallo
Crystal



CU
Cristallo/
Decoro Bluastro
Crystal/ Bluastro
Decoration



DO
Cristallo/
Decoro Oro
Crystal/ Gold
Decoration



***OO**
Oro
Gold
*Solo OG
Only OG

Finiture Finishings



CL
Cromo Lucido
Polished Chrome



***OG**
Oro Galvanizzato
Galvanized Gold
*Solo OO
Only OO

RAN ROUND

Trasparenza e leggerezza. Grazie ai bracci dalle ampie curvature, alle ogive soffiate in serie e ad i pendagli a goccia di grandi dimensioni i lampadari acquisiscono una straordinaria lievità e delicatezza. Questa è l'unica collezione che prevede anche versioni a pianta ellittica particolarmente adatte ad essere posizionate in corrispondenza di tavoli da pranzo rettangolari.

Transparency and lightness. Thanks to the wide curves of the arms, the mouth blown ogives aligned in series and the extra size drop-shaped pendants, the chandeliers appear extremely slight and delicate. This is the only collection that has elliptical versions that perfectly fit on top of rectangular dining tables.



Modelli e misure Models and sizes		Ran Round 7176-10	Ran Round 7176-14	Ran Round 7176-18
*Ogni modello prevede una catena di 100 cm inclusa. Every model is supplied with a 100 cm (39 1/4") chain.				
Peso Weight		15 kg 33 lb	21 kg 46 lb	27 kg 60 lb
Lampadine Bulbs	N. Tipo W max. N. Type W max.	10 E14 60 E12 60	14 E14 60 E12 60	18 E14 60 E12 60
Dimmerabile Dimmable		D	D	D
Lampadine incluse Bulbs included				
Certificazioni Cerification Marks				

Modelli e misure Models and sizes		Ran Round 7177-08	Ran Round 7177-12
*Ogni modello prevede una catena di 100 cm inclusa. Every model is supplied with a 100 cm (39 1/4") chain.			
Peso Weight		15 kg 33 lb	20 kg 44 lb
Lampadine Bulbs	N. Tipo W max. N. Type W max.	8 E14 60 E12 60	12 E14 60 E12 60
Dimmerabile Dimmable		D	D
Lampadine incluse Bulbs included			
Certificazioni Cerification Marks			

Modelli e misure Models and sizes		Ran Round 7177-20
*Ogni modello prevede una catena di 100 cm inclusa. Every model is supplied with a 100 cm (39 1/4") chain.		
Peso Weight		35 kg 77 lb
Lampadine Bulbs	N. Tipo W max. N. Type W max.	20 E14 60 E12 60
Dimmerabile Dimmable		D
Lampadine incluse Bulbs included		
Certificazioni Cerification Marks		

Colori disponibili Available colours					
CC Cristallo Crystal	IC Grigio Grey	EK Sabbia Sand	DK Oliva Olive	AK Blu Cadetto Cadet Blue	
LQ Bluastro Bluastro	FK Indaco Indigo	CK Pervinca Periwinkle	VI Viola Violet	*OO Oro Gold *Solo OG Only OG	

Finiture Finishings		
CL Cromo Lucido Polished Chrome	*OG Oro Galvanizzato Galvanized Gold *Solo OO Only OO	

Paralumi Shades			
Esterno: Cotone External: Cotton	BB Bianco White	NN Nero Black	NO Nero Interno Oro Black Inner Gold

RIYADH

Di grande impatto scenografico, la famiglia di lampadari Riyadh è ricca di elementi decorativi e lavorazioni a mano complesse. Un tributo al sapiente lavoro dei nostri esperti maestri vetrai. Foglie, pendagli, bossette e coppette si susseguono incessantemente in un intreccio quasi caotico per dar vita ad un disegno perfetto.

Making a highly dramatic impact, the family of Riyadh chandeliers is rich of decorative elements and complex handcrafted techniques. A tribute to our expert glass masters' skills. Leaves, pendants, "bossette" and cups come into an intricate, almost chaotic, succession to give birth to a perfect design.



Modelli e misure Models and sizes

*Ogni modello prevede una catena di 100 cm inclusa.
Every model is supplied with a 100 cm (39 1/4") chain.

	Riyadh 5349-06	Riyadh 5349-09	Riyadh 5349-12
Peso Weight	19 kg 42 lb	26 kg 58 lb	32 kg 71 lb
Lampadine Bulbs	N. Tipo W max. 6 E14 60	N. Tipo W max. 9 E14 60	N. Tipo W max. 12 E14 60
Dimmerabile Dimmable	D	D	D
Lampadine incluse Bulbs included			
Certificazioni Certification Marks			

Colori disponibili Available colours



CC
Cristallo
Crystal



BB
Bianco
White



IC
Grigio
Grey



EK
Sabbia
Sand



DK
Oliva
Olive



LQ
Bluastro
Bluastro



FK
Indaco
Indigo

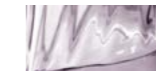

CK
Pervinca
Periwinkle



***OO**
Oro
Gold
*Solo OG
Only OG



NN
Nero
Black

Finiture Finishings



CL
Cromo Lucido
Polished Chrome



***OG**
Oro Galvanizzato
Galvanized Gold
*Solo OO
Only OO

ROSATI

Questa collezione nasce attingendo ai disegni del prezioso archivio storico di Barovier&Toso rielaborati e riproposti con un design più moderno. Linee sobrie ed eleganti, che vanno al di là delle mode. Ogni tazzina ospita al suo interno un "rostrato", piccolo gioiello di invenzione, che protegge alla vista la lampadina la cui luce si moltiplica all'infinito, passando attraverso le cuspidi che sono l'essenza stessa del rostrato.

This collection takes its cue from drawings conserved in the precious historical archives of Barovier&Toso, reworked and reformulated with a more modern design. Simple, elegant lines that transcend fashion. Each candle cup holds a little stroke of genius: a "rostrato", a piece of glass with extruded pointed tips, which hides the lamps from view. Their light is refracted infinitely as it passes through the glass tips that are at the heart of the "rostrato" technique.



Modelli e misure
Models and sizes

*Ogni modello prevede una catena di 100 cm inclusa.
 Every model is supplied with a 100 cm (39 1/4") chain.

	Rosati 5716-06	Rosati 5716-09	Rosati 5716-12	Rosati 5716-18
Peso Weight	13 kg 29 lb	17 kg 37 lb	24 kg 53 lb	35 kg 77 lb
Lampadine Bulbs	N. Tipo/Type W max. 6+1+1 G9 + G4 + Strip Led 40+1,5+1,4	9+1+1 G9 + G4 + Strip Led 40+1,5+1,4	12+1+2 G9 + G4 + Strip Led 40+1,5+1,4	18+1+2 G9 + G4 + Strip Led 40+1,5+1,4
Dimmerabile Dimmable	D G9	D G9	D G9	D G9
Lampadine incluse Bulbs included	G9 Led + G4 Led + Strip Led	G9 Led + G4 Led + Strip Led	G9 Led + G4 Led + Strip Led	G9 Led + G4 Led + Strip Led
Certificazioni Certification Marks				

Colori disponibili
Available colours

CC
 Cristallo
Crystal

IC
 Grigio
Grey

EK
 Sabbia
Sand

DK
 Oliva
Olive

AK
 Blu Cadetto
Cadet Blue

LQ
 Bluastro
Bluastro

FK
 Indaco
Indigo

CK
 Perwinka
Perwinkle

VI
 Viola
Violet

***OO**
 Oro
Gold
 *Solo OO
Only OO
Finiture
Finishings

CL
 Cromo Lucido
Polished Chrome

***OG**
 Oro Galvanizzato
Galvanized Gold
 *Solo OO
Only OO

ROTTERDAM

Bracci curvati verso l'alto, fusto ogivale, rocchetti di cristallo creati artigianalmente utilizzando un brevetto Barovier&Toso: il "rostrato". Oggetti preziosi, di straordinaria eleganza e raffinatezza capaci di soddisfare un cliente esigente e sofisticato.

Arms curving upward, an oval trunk, crystal spoons created by hand using a Barovier&Toso patent: "rostrato." Precious objects of extraordinary elegance and refinement, capable of satisfying the most demanding and sophisticated customers.



Modelli e misure <i>Models and sizes</i>	Rotterdam 5563-05	Rotterdam 5563-08	Rotterdam 5563-10	Rotterdam 5563-14
*Ogni modello prevede una catena di 100 cm inclusa. Every model is supplied with a 100 cm (39 1/4") chain.				
Peso Weight	19 kg 42 lb	24 kg 53 lb	29 kg 64 lb	35 kg 77 lb
Lampadine N. Tipo W max. Bulbs N. Type W max.	5 E14 60 E12 60	8 E14 60 E12 60	10 E14 60 E12 60	14 E14 60 E12 60
Dimmerabile Dimmable	D	D	D	D
Lampadine incluse Bulbs included				
Certificazioni Cerification Marks				

Colori disponibili
Available colours

 CC Cristallo <i>Crystal</i>	 IC Grigio <i>Grey</i>	 EK Sabbia <i>Sand</i>	 DK Oliva <i>Olive</i>	 AK Blu Cadetto <i>Cadet Blue</i>
 LQ Bluastro <i>Bluastro</i>	 FK Indaco <i>Indigo</i>	 CK Pervinca <i>Periwinkle</i>	 VI Viola <i>Violet</i>	 *OO Oro <i>Gold</i> *Solo OG <i>Only OG</i>

Finiture
Finishings

 CL Cromo Lucido <i>Polished Chrome</i>	 *OG Oro Galvanizzato <i>Galvanized Gold</i> *Solo OO <i>Only OO</i>
---	--

Paralumi
Shades
Esterno: Cotone
External: Cotton

 BB Bianco <i>White</i>	 NN Nero <i>Black</i>	 NO Nero Interno Oro <i>Black Inner Gold</i>
---	---------------------------------------	--

Modelli e misure <i>Models and sizes</i>	Rotterdam 5563-18	Rotterdam 5563-24
*Ogni modello prevede una catena di 100 cm inclusa. Every model is supplied with a 100 cm (39 1/4") chain.		
Peso Weight	41 kg 90 lb	53 kg 117 lb
Lampadine N. Tipo W max. Bulbs N. Type W max.	18 E14 60 E12 60	24 E14 60 E12 60
Dimmerabile Dimmable	D	D
Lampadine incluse Bulbs included		
Certificazioni Cerification Marks		

SAINT GERMAIN

Giorgia Brusemini

Una collezione che parte dal concetto di bidimensionalità allineando i bracci lungo lo stesso asse per dar vita ad oggetti di dimensioni contenute che non perdono tuttavia la poesia e l'incanto di un prodotto interamente realizzato a mano in cristallo veneziano. Elemento distintivo è la sfera realizzata con la tecnica dell'oro sommerso.

A collection that starts with the concept of two dimensions, extending its arms along the same axis to give rise to objects of compact size that do not, however, lose any of their poetry and enchantment. A product made entirely by hand in Venetian crystal, featuring a distinctive sphere made with the "oro sommerso" technique.



Modelli e misure Models and sizes

*Ogni modello prevede una catena di 100 cm inclusa.
Every model is supplied with a 100 cm (39 1/4") chain.

	Saint Germain 7060-02	Saint Germain 7060-03	Saint Germain 7060-05	Saint Germain 7060-07
Peso Weight	9 kg 20 lb	10 kg 22 lb	13 kg 29 lb	16 kg 35 lb
Lampadine Bulbs	N. Tipo W max. 2 E14 60	N. Tipo W max. 3 E14 60	N. Tipo W max. 5 E14 60	N. Tipo W max. 7 E14 60
Dimmerabile Dimmable	D	D	D	D
Lampadine incluse Bulbs included				
Certificazioni Certification Marks				

Colori disponibili Available colours



CC
Cristallo
Crystal



IC
Grigio
Grey



EK
Sabbia
Sand



DK
Oliva
Olive



AK
Blu Cadetto
Cadet Blue



LQ
Bluastro
Bluastro



FK
Indaco
Indigo



CK
Pervinca
Periwinkle



VI
Viola
Viola



OO
Oro
Gold

Finiture Finishings



CL
Cromo Lucido
Polished Chrome



OG
Oro Galvanizzato
Galvanized Gold

Paralumi Shades

Esterno: Cotone
External: Cotton

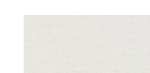
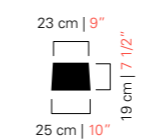

BB
Bianco
White



NN
Nero
Black



NO
Nero Interno Oro
Black Inner Gold

SAN GIORGIO

Lampadari ricchi di decorazioni molto particolari come i pendagli soffiati a forma di ampolla nella stessa colorazione dei bracci e le piramidi (punte attorcigliate). Caratteristica singolare è anche la struttura a gabbia ritorta che genera un insolito effetto di torsione enfatizzato anche dall'atipica interruzione del fusto centrale.

Chandeliers full of specific decorations such as the ampoule shaped pendants, mouth blown in the same colour of the arms, and the pyramids (curled points). The twisted main frame is a unique feature that creates an unusual torsion emphasized also by the atypical break in the central trunk.



Modelli e misure Models and sizes

*Ogni modello prevede una catena di 100 cm inclusa.
Every model is supplied with a 100 cm (39 1/4") chain.

	San Giorgio 5558-12	San Giorgio 5558-16
Peso Weight	40 kg 88 lb	65 kg 143 lb
Lampadine Bulbs	N. Tipo W max. 12 E14 60	N. Tipo W max. 16 E14 60
Dimmerabile Dimmable	D	D
Lampadine incluse Bulbs included		
Certificazioni Certification Marks		

Colori disponibili Available colours



CC
Cristallo
Crystal



BB
Bianco
White



IC
Grigio
Grey



EK
Sabbia
Sand



DK
Oliva
Olive



LQ
Bluastro
Bluastro



FK
Indaco
Indigo



CK
Perwinka
Perwinkle



***OO**
Oro
Gold
*Solo OG
Only OG



NN
Nero
Black

Finiture Finishings



CL
Cromo Lucido
Polished Chrome



***OG**
Oro Galvanizzato
Galvanized Gold
*Solo OO
Only OO

TAIF

Un'icona, sintesi perfetta di esperienze e materiali diversi, che sbalordisce per la sua ineguagliabile armonia. Un lampadario di grande successo che nasce nel 1980 per illuminare la residenza del re saudita a Taif, città da cui prende il nome. Angelo Barovier ripensa l'immagine del lampadario della tradizione muranese, preservando il valore del cristallo veneziano e accogliendo nuovi linguaggi per approdare infine all'equilibrio compiuto del Classico.

An icon; the perfect synthesis of experience and selected materials wrought with stunning and unequalled harmony. Taif was created in 1980 for the home of the Saudi king in the eponymous city of Taif, whence comes the name. Angelo Barovier rethought the image of the traditional Murano chandelier, preserving the value of Venetian crystal while incorporating new languages. An amalgam, then, of tradition and creativity, of memory and innovation, from which blossoms the time-tested equilibrium of the classical.



Modelli e misure Models and sizes

*Ogni modello prevede una catena di 100 cm inclusa.
Every model is supplied with a 100 cm (39 1/4") chain.

	Taif 5350-06	Taif 5350-09	Taif 5350-12	Taif 5350-18
Peso Weight	30 kg 66 lb	42 kg 93 lb	55 kg 122 lb	74 kg 163 lb
Lampadine N. Tipo W max. Bulbs N. Type W max.	6 E14 60 E12 60	9 E14 60 E12 60	12 E14 60 E12 60	18 E14 60 E12 60
Dimmerabile Dimmable	D	D	D	D
Lampadine incluse Bulbs included				
Certificazioni Certification Marks				

Colori disponibili Available colours



CC
Cristallo
Crystal



BB
Bianco
White



IC
Grigio
Grey



EK
Sabbia
Sand



DK
Oliva
Olive



LQ
Bluastro
Bluastro



FK
Indaco
Indigo



CK
Pervinca
Periwinkle



***OO**
Oro
Gold
*Solo OG
Only OG



NN
Nero
Black

Finiture Finishings



CL
Cromo Lucido
Polished Chrome



***OG**
Oro Galvanizzato
Galvanized Gold
*Solo OO
Only OO

TANGERI

Sfere riccamente decorate e pastorali abilmente ritorti si alternano in questa collezione che attinge alla tradizione ma il cui disegno, alleggerito e semplificato, ben si adatta sia ad interni di gusto classico che contemporaneo. I paralumi con la finitura interna oro sono perfetti per donare un'atmosfera calda e ricercata.

Richly decorated spheres and gracefully curled pastorals alternate in this collection that draws on the tradition while, lightening and simplifying the design, makes it perfect for both classic and contemporary settings. The shades with an inner gold finish produce a warm, refined atmosphere.



Modelli e misure Models and sizes

*Ogni modello prevede una catena di 100 cm inclusa.
Every model is supplied with a 100 cm (39 1/4") chain.

	Tangeri 5604-08	Tangeri 5604-12	Tangeri 5604-16
Peso Weight	15 kg 33 lb	23 kg 51 lb	45 kg 99 lb
Lampadine Bulbs	N. Tipo W max. 8 E14 60	N. Tipo W max. 12 E14 60	N. Tipo W max. 16 E14 60
Dimmerabile Dimmable	D	D	D
Lampadine incluse Bulbs included			
Certificazioni Certification Marks			

Colori disponibili Available colours



CC
Cristallo
Crystal



IC
Grigio
Grey



EK
Sabbia
Sand



DK
Oliva
Olive



AK
Blu Cadetto
Cadet Blue



LQ
Bluastro
Bluastro



FK
Indaco
Indigo



CK
Pervinca
Periwinkle



VI
Viola
Violet



***OO**
Oro
Gold
*Solo OG
Only OG

Finiture Finishings



CL
Cromo Lucido
Polished Chrome



***OG**
Oro Galvanizzato
Galvanized Gold
*Solo OO
Only OO

Paralumi Shades

Esterno: Cotone
External: Cotton

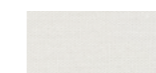
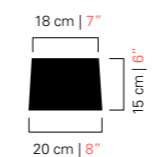

BB
Bianco
White



NN
Nero
Black



NO
Nero Interno Oro
Black Inner Gold





TWINS

Come in un passato mai passato la materia vetro prende forma, e la luce si alterna alle ombre in un vigoroso abbraccio vorticante. Sulle orme dei successi del passato recente, un lampadario orizzontale dall'aspetto vigoroso ma raffinato. Il cristallo dei bracci, molto materico, è trasparente mentre le lampade sono racchiuse in tazzine di colore bianco opaco che diffonde e ammorbidisce la luce.

In a past that is ever present, the glass takes shape and light alternates with shadows to generate a vigorous, vertiginous embrace. On the heels of the successes of the recent past, an horizontal chandelier with a vigorous yet refined appearance. The arms' crystal, which is very material, is transparent, while the light bulbs are enclosed in opaque white cups which diffuse and soften the light.

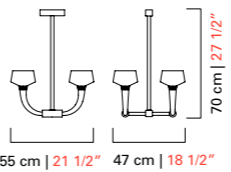
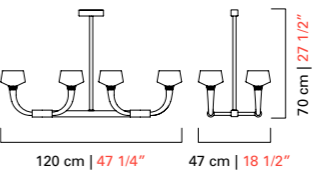
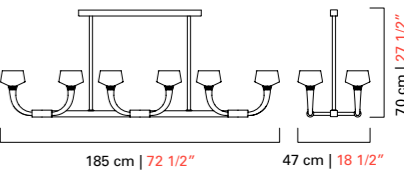

Modelli e misure Models and sizes

	Twins 7226-04	Twins 7226-08	Twins 7226-12
			
Peso Weight	10 kg 22 lb	18 kg 40 lb	32 kg 70 lb
Lampadine N. Tipo W max. Bulbs N. Type W max.	4 G9 40 40	8 G9 40 40	12 G9 40 40
Dimmerabile Dimmable	D	D	D
Lampadine incluse Bulbs included	G9 Led	G9 Led	G9 Led
Certificazioni Cerification Marks			

Colori disponibili Available colours



BC
Bianco/ Cristallo
White/ Crystal



OY
Oro Beige/ Oro
Gold Beige/ Gold

Finiture Finishings



CL
Cromo Lucido
Polished Chrome



CN
Cromo Nero
Dark Chrome



OF
Ottone
Spazzolato Fine
Fine Brushed Brass

VALIANT

Un disegno anni '20, linee pulite, solo alcuni elementi decorativi ed una disposizione insolitamente fitta dei bracci. Un oggetto essenziale che non passa mai di moda particolarmente adatto ad ambienti contemporanei.

A drawing from the 20ies, clean lines, just few decorative elements and an unusually dense arrangement of the arms. An essential object that never goes out of fashion, particularly suitable for contemporary interiors.



Modelli e misure Models and sizes

*Ogni modello prevede una catena di 100 cm inclusa.
Every model is supplied with a 100 cm (39 1/4") chain.

	Valiant 5507-06	Valiant 5507-09	Valiant 5507-12	Valiant 5507-18
Peso Weight	8 kg 18 lb	10 kg 22 lb	13 kg 29 lb	20 kg 44 lb
Lampadine Bulbs	N. Tipo W max. 6 E14 60	N. Tipo W max. 9 E14 60	N. Tipo W max. 12 E14 60	N. Tipo W max. 18 E14 60
Dimmerabile Dimmable	D	D	D	D
Lampadine incluse Bulbs included				
Certificazioni Certification Marks				

Colori disponibili Available colours



CC
Cristallo
Crystal



IC
Grigio
Grey



EK
Sabbia
Sand



DK
Oliva
Olive



AK
Blu Cadetto
Cadet Blue



LQ
Bluastro
Bluastro



FK
Indaco
Indigo



CK
Pervinca
Periwinkle



VI
Viola
Violet



***OO**
Oro
Gold
*Solo OO
Only OO

Finiture Finishings



CL
Cromo Lucido
Polished Chrome



***OG**
Oro Galvanizzato
Galvanized Gold
*Solo OO
Only OO

ENEZIA 1295

L'origine di tutto, il compendio di settecento anni di tradizioni tramandate di padre in figlio, oltre le mode e il tempo che scorre: una collezione di lampadari ricca di storia, di dettagli e di emozioni. È composta da quattro lampadari tutti caratterizzati da un elemento ricorrente: il "rostrato", un'invenzione del secolo scorso di Ercole Barovier che prende origine dalle tecniche di lavorazione artigianali dei suoi avi.

At the very heart of it all is the culmination of seven hundred years of tradition handed down from father to son through changing times and fashions: a collection of chandeliers rich in history, detail and emotion. It is comprised of four chandeliers all featuring a recurring motif: "rostrato", invented by Ercole Barovier almost a century ago developing techniques used by his ancestors.



Modelli e misure
Models and sizes

*Ogni modello prevede una catena di 100 cm inclusa.
Every model is supplied with a 100 cm (39 1/4") chain.

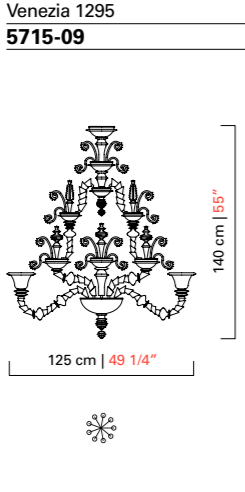
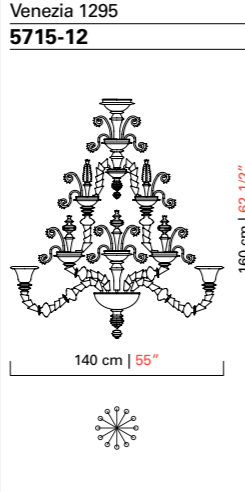
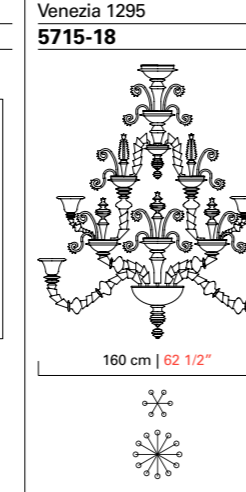
	Venezia 1295 5715-09	Venezia 1295 5715-12	Venezia 1295 5715-18
			
Peso Weight	49 kg 107 lb	62 kg 136 lb	85 kg 187 lb
Lampadine N. Tipo W max. Bulbs N. Type W max.	9 E14 60 E12 60	12 E14 60 E12 60	18 E14 60 E12 60
Dimmerabile Dimmable	D	D	D
Lampadine incluse Bulbs included			
Certificazioni Certification Marks			

Colori disponibili
Available colours



CC
Cristallo
Crystal

Finiture
Finishings



CL
Cromo Lucido
Polished Chrome



OG
Oro Galvanizzato
Galvanized Gold

Modelli e misure
Models and sizes

*Ogni modello prevede una catena di 100 cm inclusa.
Every model is supplied with a 100 cm (39 1/4") chain.

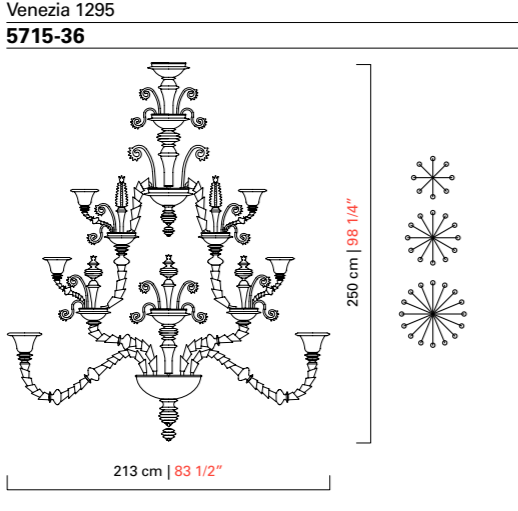
	Venezia 1295 5715-36
	
Peso Weight	185 kg 407 lb
Lampadine N. Tipo W max. Bulbs N. Type W max.	36 E14 60 E12 60
Dimmerabile Dimmable	D
Lampadine incluse Bulbs included	
Certificazioni Certification Marks	

VERMONT

Elemento caratterizzante di questa collezione sono le grandi sfere in cristallo veneziano soffiato. Si distribuiscono sia in verticale che in orizzontale come a formare un'eterea ma preziosa nuvola di vetro.

The large Venetian crystal spheres are the distinctive elements of this collection. With their horizontal and vertical distribution, they generate an ethereal but at the same time precious crystal cloud.



Modelli e misure Models and sizes

*Ogni modello prevede una catena di 100 cm inclusa.
Every model is supplied with a 100 cm (39 1/4") chain.

	Vermont 5550-06	Vermont 5550-09	Vermont 5550-12	Vermont 5550-18
Peso Weight	10 kg 22 lb	13 kg 29 lb	16 kg 36 lb	24 kg 53 lb
Lampadine N. Tipo W max. Bulbs N. Type W max.	6 E14 60 E12 60	9 E14 60 E12 60	12 E14 60 E12 60	18 E14 60 E12 60
Dimmerabile Dimmable	D	D	D	D
Lampadine incluse Bulbs included				
Certificazioni Certification Marks				

Colori disponibili Available colours



CC
Cristallo
Crystal



IC
Grigio
Grey



EK
Sabbia
Sand



DK
Oliva
Olive



AK
Blu Cadetto
Cadet Blue



LQ
Bluastro
Bluastro



FK
Indaco
Indigo



CK
Pervinca
Periwinkle



VI
Viola
Violet



***OO**
Oro
Gold
*Solo OG
Only OG

Finiture Finishings



CL
Cromo Lucido
Polished Chrome



***OG**
Oro Galvanizzato
Galvanized Gold
*Solo OO
Only OO

Paralumi Shades

Esterno: Cotone
External: Cotton

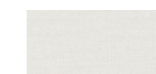
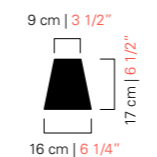

BB
Bianco
White



NN
Nero
Black



NO
Nero Interno Oro
Black Inner Gold

VERTIGO

Vertigo si ispira alle atmosfere glamour ed ammalianti degli anni '20, capaci di rievocare quel vivace fermento che investì le arti visive, il design, l'architettura e la moda dell'epoca. Attingendo a quelle vibranti tendenze estetiche, che videro New York, Mosca, Berlino e Parigi trasformarsi in capitali del lusso, del divertimento e della bella vita. Una nuova collezione affascinante e raffinata, carica di una tensione espressiva intensa e sensuale.

Vertigo takes its cue from the glamorous, seductive atmospheres of the 1920s, drawing on the lively ferment in the visual arts, design, architecture and fashion in that period. Referencing the vibrant aesthetic trends that made New York, Moscow, Berlin and Paris into worldwide capitals of luxury, entertainment and lifestyle. A new collection fascinating and refined, charged with intense and sensual expressive energy.



Modelli e misure
Models and sizes

*Ogni modello prevede una catena di 100 cm inclusa.
 Every model is supplied with a 100 cm (39 1/4") chain.

	Vertigo 5719-06	Vertigo 5719-09	Vertigo 5719-12	Vertigo 5719-18
Peso Weight	12 kg 26 lb	17 kg 37 lb	25 kg 55 lb	38 kg 84 lb
Lampadine Bulbs	N. Tipo W max. 6+1 G9+G4 7+1,5	N. Tipo W max. 9+1 G9+G4 7+1,5	N. Tipo W max. 12+1 G9+G4 7+1,5	N. Tipo W max. 18+1 G9+G4 7+1,5
Dimmerabile Dimmable	D G9	D G9	D G9	D G9
Lampadine incluse Bulbs included	G9 Led + G4 Led	G9 Led + G4 Led	G9 Led + G4 Led	G9 Led + G4 Led
Certificazioni Cerification Marks				

Colori disponibili
Available colours

CC
Cristallo
Crystal



IC
Grigio
Grey



EK
Sabbia
Sand



DK
Oliva
Olive



AK
Blu Cadetto
Cadet Blue



LQ
Bluastro
Bluastro



FK
Indaco
Indigo

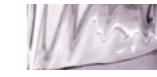

CK
Pervinca
Periwinkle



VI
Viola
Violet



OO
Oro
Gold

Finiture
Finishings

NJ
Nickel Nero
Spazzolato
Brushed Black
Nickel



OJ
Oro Spazzolato
Brushed Gold

WINDSOR

Bracci sinuosi ed eleganti, che si dipanano da un corpo centrale snello e slanciato in un gioco visivo di intrecci, e si allineano ingegnosamente su uno stesso piano, sono la peculiarità della collezione. Le tazzine portalampada sono sempre bianco opaco con una sfumatura nella stessa tonalità dei bracci.

Sinuuous, elegant arms which unfurl from a slender central body in a visual game of twists, and which are smartly aligned on a same plane: these are the distinctive features of the collection. The lamp-holder cups are always opaque white with a shade whose tonality is the same as the arms.



Modelli e misure Models and sizes

*Ogni modello prevede una catena di 100 cm inclusa.
Every model is supplied with a 100 cm (39 1/4") chain.

Windsor 5676-10	Windsor 5676-14	Windsor 5676-24

Peso Weight	21 kg 46 lb	33 kg 73 lb	50 kg 110 lb
Lampadine Bulbs	N. 10 Tipo E14 W max. 60	N. 14 Tipo E14 W max. 60	N. 24 Tipo E14 W max. 60
Dimmerabile Dimmable	D	D	D
Lampadine incluse Bulbs included			
Certificazioni Certification Marks			

Colori disponibili Available colours



CC
Cristallo
Crystal



IC
Grigio
Grey



EK
Sabbia
Sand



DK
Oliva
Olive



AK
Blu Cadetto
Cadet Blue



LQ
Bluastro
Bluastro



FK
Indaco
Indigo



CK
Pervinca
Perwinkle



VI
Viola
Violet



***OO**
Oro
Gold
*Solo OO
Only OG

Finiture Finishings



CL
Cromo Lucido
Polished Chrome



***OG**
Oro Galvanizzato
Galvanized Gold
*Solo OO
Only OG



SUSPENSIONS

Una collezione ampiamente variegata e versatile, capace di rievocare altre epoche o di aggiungere un accento contemporaneo all'ambiente. Lavorazioni tradizionali sposano forme eclettiche, dando vita a creazioni che fluttuano sospese nell'aria.

A variegated and versatile collection capable of suggesting other eras, or of adding a contemporary accent to spaces. Traditional workmanship meets eclectic forms, in creations that seem to float in the air.

AGAVE

García Cumini

Agave è una collezione ispirata alla pianta omonima, simbolo di eleganza e resilienza, reinterpretata in cristallo veneziano dai designer García Cumini. La sua iconica foglia allungata richiama la tradizione vetraria di Barovier&Toso ed è arricchita dalla tecnica della rugiada, che ne esalta la brillantezza e la texture tridimensionale. Un innovativo effetto sfumato, ottenuto con graniglia di vetro colorato, valorizza ulteriormente il design. Questa lavorazione diffonde la luce in modo dinamico, evocando i raggi solari filtrati tra le foglie dell'agave.

Agave is a collection inspired by the plant of the same name, a symbol of elegance and resilience, reinterpreted in Venetian crystal by designers García Cumini. Its iconic elongated leaf recalls Barovier&Toso's glassmaking tradition and is enriched by the dew technique, which enhances its brilliance and three-dimensional texture. An innovative shaded effect, obtained with coloured glass beads, further enhances the design. This workmanship diffuses light dynamically, evoking the sun's rays filtered through the leaves of the agave.



Modelli e misure Models and sizes

Agave

7572-00

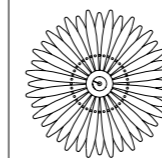
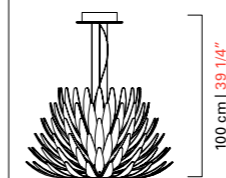

Peso Weight	60 kg 132 lb
Lampadine Bulbs	N. Tipo/Type W max. 6+1 Strip Led + Led 8+8 8+8
Dimmerabile Dimmable	D
Lampadine incluse Bulbs included	Strip Led + Led
Certificazioni Cerification Marks	

Colori disponibili Available colours



CR
Cristallo Rugiada
Crystal Rugiada



GQ
Cristallo Cognac
Rugiada
Crystal Cognac
Rugiada

Finiture Finishings



CL
Cromo Lucido
Polished Chrome

ANGEL



Al Design

Angel è una spirale di piume di cristallo, che si avvolge su sé stessa con dinamismo, e che fluttua nello spazio come un'ala vaporosa che si dispiega leggera. Ogni piuma è illuminata da led, così come l'attacco a soffitto.

Angel is a spiral of crystal plumage, which wraps around itself with dynamism and floats in space like a vaporous wing unfolding lightly. Each feather is lit by led, as well as the ceiling connection.

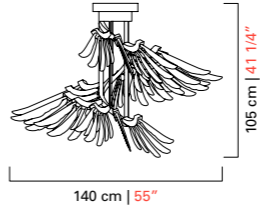
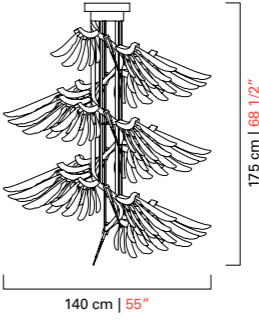

Modelli e misure Models and sizes

	Angel 7248-00	Angel 7249-00
		
Peso Weight	35 kg 77 lb	60 kg 132 lb
Lampadine Bulbs	N. Tipo/Type W max. 80+1+1 Led + GU10 + Strip Led 1+7+21	135+1+1 Led + GU10 + Strip Led 1+7+21
Dimmerabile Dimmable		
Lampadine incluse Bulbs included	Led + GU10 Led + Strip Led	Led + GU10 Led + Strip Led
Certificazioni Certification Marks		

Colori disponibili Available colours



CC
Cristallo
Crystal

Finiture Finishings



VM
Verniciato Mirra
Painted Myrrh

CAMPANULA

García Cumini

Una bellezza gentile, che trova origine ed eco nella natura, nella sua capacità di farsi multiplo, ogni volta in modo nuovo e spontaneo. La modularità di questa collezione coniuga la tradizione delle lavorazioni artigianali ad una modalità compositiva contemporanea e vivace. Equilibrate ed eleganti, le sospensioni protendono nello spazio, seguendo prevalentemente un asse verticale. Protagonista il cristallo veneziano, brillante e ipnotico, perfetto interprete di un archetipo floreale.

Gentle beauty that originates in echoes of nature, with its ability to multiply, always in new, spontaneous ways. The modular design of this collection combines the tradition of craftsmanship with a contemporary, lively approach to composition. Poised and elegant, the suspensions extend into space, following a primarily vertical axis. The protagonist is Venetian Crystal, bright and hypnotic, a perfect embodiment of a floral archetype.



Modelli e misure <i>Models and sizes</i>	Campanula 7432-00			Campanula 7433-00			Campanula 7434-00			Campanula 7435-00		
Peso Weight	16 kg 35 lb			10 kg 22 lb			8 kg 17,5 lb			13 kg 28,5 lb		
Lampadine Bulbs	N. Tipo W max.	1	Led 12,6	N. Tipo W max.	1	Led 12,6	N. Tipo W max.	1	Led 12,6	N. Tipo W max.	1	Led 12,6
Dimmerabile Dimmable	D			D			D			D		
Lampadine incluse Bulbs included	Led			Led			Led			Led		
Certificazioni Cerification Marks	EAC			EAC			EAC			EAC		

Modelli e misure <i>Models and sizes</i>	Campanula 7436-00			Campanula 7437-00			Campanula 7438-00			Campanula 7439-00		
Peso Weight	9 kg 20 lb			11 kg 22,5 lb			9 kg 20 lb			7 kg 15,5 lb		
Lampadine Bulbs	N. Tipo W max.	1	Led 12,6	N. Tipo W max.	1	Led 6,3	N. Tipo W max.	1	Led 6,3	N. Tipo W max.	1	Led 6,3
Dimmerabile Dimmable	D			D			D			D		
Lampadine incluse Bulbs included	Led			Led			Led			Led		
Certificazioni Cerification Marks	EAC			EAC			EAC			EAC		

Colori disponibili
Available colours**CC**
Cristallo
Crystal**EB**
Cristallo / Grigio /
Brown
*Crystal / Grey /
Brown***ED**
Cristallo / Grigio /
Oliva
*Crystal / Grey /
Olive***EF**
Cristallo / Grigio /
Blu Cadetto
*Crystal / Grey /
Cadet Blue***Finiture**
Finishings**CL**
Cromo Lucido
Polished Chrome

CLEPSYDRA

Simmetria e ordine danno vita a sospensioni molto ricche, dal magico fascino. Sono composizioni dense e brillanti, ottenute per moltiplicazione di un singolo elemento, che rivisita un design degli anni '60, presente nello storico archivio Barovier&Toso. Sinuosamente progettate per combaciare perfettamente, le clessidre sono realizzate con l'antica tecnica del Rigadin. Soffiando il cristallo all'interno di uno stampo chiamato "fracco", si ottengono sottili costolature lungo tutta la superficie dell'oggetto. Grazie a queste rigature, ogni sospensione accende una danza di riflessi luminosi.

Symmetry and order generate very elegant suspension lamps of magical charm. These are intense, bright compositions, obtained through multiplication of a single element, linking back to a design from the 1960s contained in the historical archives of Barovier&Toso. With sinuous forms for perfect matching, the hourglasses are made with the age-old Rigadin technique. The glass is blown inside a mould known as a "fracco," producing slender ribbing along the entire surface of the object. Thanks to these lines, every suspension lamp triggers a dance of luminous reflections.



Modelli e misure <i>Models and sizes</i>	Clepsydra 7478-00	Clepsydra 7479-00	Clepsydra 7480-00	Clepsydra 7481-00
Peso Weight	115 kg 253 lb	185 kg 407 lb	70 kg 154 lb	120 kg 264 lb
Lampadine Bulbs	N. Tipo W max. 16 E14 40	N. Tipo W max. 24 E14 40	N. Tipo W max. 12+2 E14+G9 40+20	N. Tipo W max. 16+2 E14+G9 40+20
Dimmerabile Dimmable	D	D	D	D
Lampadine incluse Bulbs included			G9 Led	G9 Led
Certificazioni Cerification Marks	ERAC	ERAC	ERAC	ERAC

Colori disponibili
Available colours



CC
Cristallo
Crystal



FE
Cristallo / Sabbia
Crystal / Sand

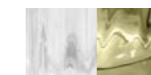

FD
Cristallo / Oliva
Crystal / Olive



FF
Cristallo / Blu Cadetto
Crystal / Cadet Blue



FP
Cristallo / Pervinca
Crystal / Perwinkle

Finiture
Finishings



CL
Cromo Lucido
Polished Chrome



OG
Oro Galvanizzato
Galvanized Gold

Modelli e misure <i>Models and sizes</i>	Clepsydra 7482-00	Clepsydra 7483-00	Clepsydra 7484-00
Peso Weight	52 kg 114 lb	110 kg 242 lb	200 kg 440 lb
Lampadine Bulbs	N. Tipo W max. 8 G9 20	N. Tipo W max. 22 E14 40	N. Tipo W max. 38 E14 40
Dimmerabile Dimmable	D	D	D
Lampadine incluse Bulbs included	G9 Led		
Certificazioni Cerification Marks	ERAC	ERAC	ERAC





COLIMAÇON



Marc Sadler

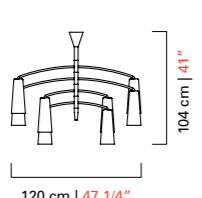
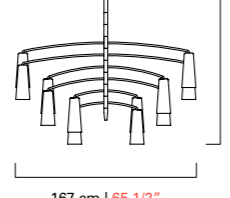
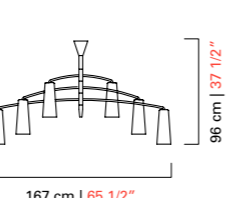
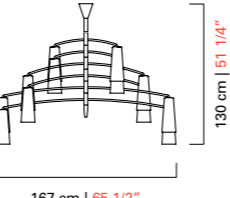



Come sculture mobili queste sospensioni grazie alla cinetica dei bracci consentono di ottenere configurazioni sempre diverse. In antitesi alla staticità della sospensione tradizionale questi oggetti giocano con il delicato equilibrio tra pesi e dimensioni creando un effetto di estrema lievità e delicatezza. È proposto in nove modelli, ma le possibilità costruttive sono infinite.

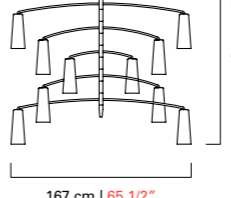

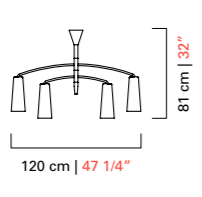
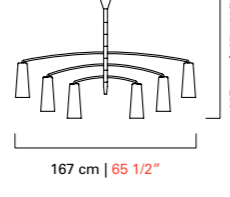
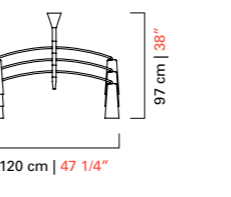
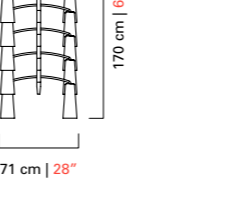

Like mobile sculptures, thanks to the kinetics of the arms these suspensions make it possible to create many different configurations. As opposed to the static character of traditional lamps, these objects play with a delicate balance of weights and proportions to generate an effect of extreme lightness and delicacy. It is available in nine models, but with infinite possible combinations.



Modelli e misure <i>Models and sizes</i>	Colimaçon 7206-00	Colimaçon 7207-00	Colimaçon 7208-00	Colimaçon 7209-00
				
Peso Weight	28 kg 62 lb	43 kg 95 lb	23 kg 51 lb	42 kg 92 lb
Lampadine N. Tipo W max. Bulbs N. Type W max.	8 E14 40 E12 40	12 E14 40 E12 40	6 E14 40 E12 40	12 E14 40 E12 40
Dimmerabile Dimmable	D	D	D	D
Lampadine incluse Bulbs included				
Certificazioni Cerification Marks				

Modelli e misure <i>Models and sizes</i>	Colimaçon 7214-00
	
Peso Weight	37 kg 81 lb
Lampadine N. Tipo W max. Bulbs N. Type W max.	10 E14 40 E12 40
Dimmerabile Dimmable	D
Lampadine incluse Bulbs included	
Certificazioni Cerification Marks	

Modelli e misure <i>Models and sizes</i>	Colimaçon 7210-00	Colimaçon 7211-00	Colimaçon 7212-00	Colimaçon 7213-00
				
Peso Weight	16 kg 35 lb	23 kg 51 lb	23 kg 51 lb	35 kg 77 lb
Lampadine N. Tipo W max. Bulbs N. Type W max.	4 E14 40 E12 40	6 E14 40 E12 40	6 E14 40 E12 40	10 E14 40 E12 40
Dimmerabile Dimmable	D	D	D	D
Lampadine incluse Bulbs included				
Certificazioni Cerification Marks				

Colori disponibili <i>Available colours</i>			
	OB Oro Beige Beige Gold	IN Grigio/ Bianco Grey/ White	BH Bluastro/ Bianco Bluastro/ White
Finiture <i>Finishings</i>			
	CN Cromo Nero Dark Chrome	OG Oro Galvanizzato Galvanized Gold	

CROWN

Brian Rasmussen

Una collezione che celebra ed esalta uno degli elementi caratterizzanti dei lampadari della tradizione veneziana, il "pastorale": un piccolo bastone dall'estremità ritorta a spirale caratterizzato dalla lavorazione "rigà menà". Ingrandito a dismisura, appeso al contrario e replicato in serie diventa il protagonista di queste sospensioni dal disegno minimalista e moderno. Proposto in tre diverse configurazioni (a uno, due o tre livelli).

A collection that pays tribute to and enhances one of the characteristic features of the chandeliers of the Venetian tradition, the "pastorale": a small rod terminating in a spiral, made with the "rigà menà" technique. Forcefully enlarged, suspended upside-down and replicated in a series, this piece becomes the protagonist of suspension lamps with a modern minimalist design. Available in three different configurations (one, two or three-tiers).



Modelli e misure Models and sizes	Crown 7334-00	Crown 7335-00	Crown 7336-00
Peso Weight	15 kg 33 lb	23 kg 51 lb	30 kg 66 lb
Lampadine N. Tipo W max. Bulbs N. Type W max.	1 Strip Led 46 46	1 Strip Led 73 73	1 Strip Led 105 105
Dimmerabile Dimmable	D	D	D
Lampadine incluse Bulbs included	Strip Led	Strip Led	Strip Led
Certificazioni Certification Marks	ERAC	ERAC	ERAC

Colori disponibili
Available coloursCC
Cristallo
Crystal**Finiture**
FinishingsVY
Verniciato Grigio
Painted Grey

Modelli e misure Models and sizes	Crown 7337-00	Crown 7338-00	Crown 7339-00
Peso Weight	39 kg 86 lb	55 kg 121 lb	70 kg 154 lb
Lampadine N. Tipo W max. Bulbs N. Type W max.	2 Strip Led 46+73 46+73	2 Strip Led 73+105 73+105	3 Strip Led 46+73+105 46+73+105
Dimmerabile Dimmable	D	D	D
Lampadine incluse Bulbs included	Strip Led	Strip Led	Strip Led
Certificazioni Certification Marks	ERAC	ERAC	ERAC

EMPIRE

Nuvole di tubi a sezione quadrata compongono sospensioni dai volumi piramidali, ispirandosi alle geometrie rigorose ed energiche tipiche dell'Art Déco. Gli elementi si sovrappongono, si affiancano, con lunghezze diverse e con una ritmata alternanza di colori, nelle versioni policrome. L'effetto luminoso d'insieme è soffuso, ma costellato da scintillii puntuali, frutto di particolari rifrazioni. A produrre questi giochi di luce sono le superfici leggermente ondulate dei tubi, ottenute per mezzo di una speciale lavorazione, detta a corteccia. Eseguita artigianalmente, si realizza con l'ausilio di uno stampo metallico, le cui irregolarità vengono trasferite sul vetro all'atto della soffiatura.

Clouds of tubes with a square cross-section form pyramid-shaped suspensions, inspired by the rigorous and energetic geometric stylings typical of Art Deco. The parts are overlaid and juxtaposed, with different lengths and a rhythmical alternation of colours in the polychrome versions. The luminous effect is soft but punctuated by sparkling highlights produced by particular refractions. The games of light are produced by the slightly undulated surfaces of the tubes, obtained by means of a special technique known as a corteccia. The lamps are made by hand with the aid of a metal mould, whose irregularities are transferred onto the glass during the blowing procedure.

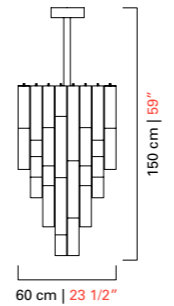
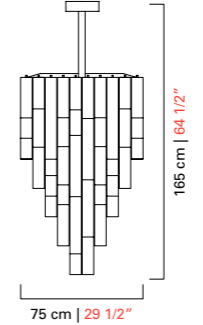
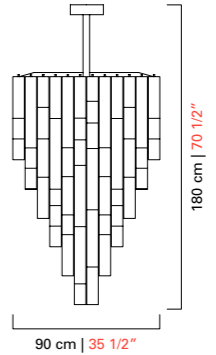
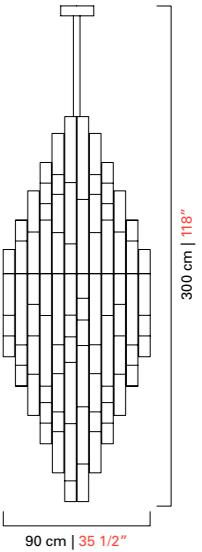

Modelli e misure Models and sizes

	Empire 7469-00	Empire 7470-00	Empire 7471-00	Empire 7472-00
				
Peso Weight	100 kg 220 lb	160 kg 352 lb	230 kg 506 lb	400 kg 880 lb
Lampadine N. Tipo W max. Bulbs N. Type W max.	13 E14 40 E12 40	21 E14 40 E12 40	32 E14 40 E12 40	45 E14 40 E12 40
Dimmerabile Dimmable	D	D	D	D
Lampadine incluse Bulbs included				
Certificazioni Certification Marks	CEC	CEC	CEC	CEC

Colori disponibili Available colours



CC
Cristallo
Crystal



EE
Cristallo / Grigio /
Sabbia
Crystal / Grey /
Sand



ED
Cristallo / Grigio /
Oliva
Crystal / Grey /
Olive



EF
Cristallo / Grigio /
Blu Cadetto
Crystal / Grey /
Cadet Blue

Finiture Finishings



CL
Cromo Lucido
Polished Chrome



OG
Oro Galvanizzato
Galvanized Gold

EVA

Le grandi ogive sospese identificano questa collezione estremamente moderna. La leggerezza è la caratteristica principale che la rende adatta ad ogni progetto di interni.

The great hanging ogives identify this modern collection. Lightness is the main feature which makes it suitable for any interior design project.



Modelli e misure Models and sizes

Eva
7057-00

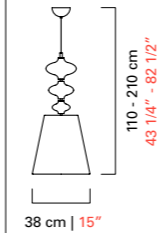

Peso Weight	8 kg 18 lb
Lampadine Bulbs	N. Tipo W max. N. Type W max. 1 E27 100 E26 60
Dimmerabile Dimmable	D
Lampadine incluse Bulbs included	
Certificazioni Certification Marks	UL ENEC c UL US

Colori disponibili Available colours



CC
Cristallo
Crystal



IC
Grigio
Grey



EK
Sabbia
Sand



DK
Oliva
Olive



AK
Blu Cadetto
Cadet Blue



LQ
Bluastro
Bluastro



FK
Indaco
Indigo



CK
Pervinca
Periwinkle



VI
Viola
Violet



OO
Oro
Gold

Finiture Finishings



CN
Cromo Nero
Dark Chrome



OF
Ottone
Spazzolato Fine
Fine Brushed Brass

Paralumi Shades

Esterno: Cotone
External: Cotton

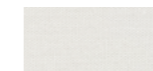
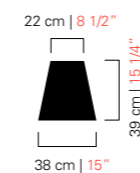

BB
Bianco
White



NN
Nero
Black



NO
Nero Interno Oro
Black Inner Gold

EXAGON

Come lucciole che si librano nelle profondità di una cascata di vetro, in una danza luminosa che affascina e crea atmosfera, queste foglie di loto, trasparenti e impreziosite da piccole scaglie d'oro oppure in colori tenui, fluttuano luminose.

As fireflies unleashed from the depths of a glass cascade in a sparkling dance, creating an enchanting atmosphere, these transparent lotus leaves, embellished with tiny gold flakes or in pale colours, float in the air.



Modelli e misure Models and sizes

	Exagon 7125-00	Exagon 7126-00	Exagon 7127-00	Exagon 7128-00
Peso Weight	18 kg 40 lb	45 kg 99 lb	100 kg 220 lb	155 kg 341 lb
Lampadine N. Tipo W max. Bulbs N. Type W max.	1+18 G53+Led 15+0,36	4+56 G53+Led 15+0,36	12+136 G53+Led 15+0,36	16+200 G53+Led 15+0,36
Dimmerabile Dimmable	D (G53)	D (G53)	D (G53)	D (G53)
Lampadine incluse Bulbs included	G53 Led + Led	G53 Led + Led	G53 Led + Led	G53 Led + Led
Certificazioni Certification Marks				

Colori disponibili Available colours



CC
Cristallo
Crystal



IC
Grigio
Grey



EK
Sabbia
Sand



DK
Oliva
Olive



AK
Blu Cadetto
Cadet Blue



LQ
Bluastro
Bluastro



FK
Indaco
Indigo



CK
Pervinca
Periwinkle



VI
Viola
Violet



OO
Oro
Gold

Finiture Finishings



CL
Cromo Lucido
Polished Chrome

FANALI VENEZIANI

Una collezione che rende omaggio alla storia della città di Venezia e alle lanterne usate durante il medioevo per illuminare le calli. Un disegno classico ed elegante declinato in cinque tipologie da usare singolarmente o in serie.

A collection that pays homage to the history of the city of Venice and the lanterns used in the Middle Ages to light the streets. A classic and elegant design interpreted in five typologies that can be used individually or in groups.



Modelli e misure <i>Models and sizes</i>	Fanali Veneziani			Fanali Veneziani			Fanali Veneziani			Fanali Veneziani		
	5381-00			5382-00			5383-00			4428-00		
Peso Weight	7 kg 15 lb			7 kg 15 lb			7 kg 15 lb			6 kg 13 lb		
Lampadine N. Tipo W max. Bulbs N. Type W max.	1	E27	100	1	E27	100	1	E27	100	1	E27	100
Dimmerabile Dimmable	D			D			D			D		
Lampadine incluse Bulbs included												
Certificazioni Certification Marks												

Modelli e misure <i>Models and sizes</i>	Fanali Veneziani		
	4430-00		
Peso Weight	6 kg 13 lb		
Lampadine N. Tipo W max. Bulbs N. Type W max.	1	E27	100
Dimmerabile Dimmable	D		
Lampadine incluse Bulbs included			
Certificazioni Certification Marks			

Colori disponibili
Available colours**CC**
Cristallo
Crystal**DO**
Cristallo/
Decoro Oro
*Crystal/ Gold
Decoration***OO**
Oro
Gold**OB**
Oro Beige
*Beige Gold***Finiture**
Finishings**OG**
Oro Galvanizzato
Galvanized Gold

GALLIA

Una famiglia di lampade eleganti ispirate alla regolarità del classico e rese senza tempo dai colori caldi e avvolgenti: il diffusore opalino è beige con pagliuzze dorate, mentre varia il colore dell'elemento sferico. La sospensione è disponibile con due o quattro luci, la prima anche in due altezze diverse.

A family of elegant lamps inspired by regular, classical lines and rendered timeless by the warm and welcoming colours: the opaline diffuser is beige, speckled with gold, while the sphere element can be of different colours. The suspension lamp is available with two or four lights, the first one also in two different heights.



Modelli e misure Models and sizes

	Gallia 5628-00	Gallia 5624-00	Gallia 5629-00
Peso Weight	9 kg 20 lb	10 kg 22 lb	20 kg 44 lb
Lampadine Bulbs	N. Tipo W max. 2 E27 100	N. Tipo W max. 2 E27 100	N. Tipo W max. 4 E27 100
Dimmerabile Dimmable	D	D	D
Lampadine incluse Bulbs included			
Certificazioni Certification Marks			

Colori disponibili Available colours

*A ogni colore è sempre abbinata la foglia oro.
Each colour is always combined with gold leaf.



OY
Oro Beige/
Oro
Gold Beige/
Gold



OW
Oro Beige/
Verde Oro
Gold Beige/
Green Gold



OK
Oro Beige/
Nero Oro
Gold Beige/
Black Gold

Finiture Finishings



OG
Oro Galvanizzato
Galvanized Gold



OF
Ottone
Spazzolato Fine
Fine Brushed Brass

GERMOGLI

Domina la scena un involuppo di canne luminose, avvolte da foglie rampicanti, interamente realizzate in cristallo veneziano. Risalgono agli anni '80 i disegni dello storico archivio Barovier&Toso ai quali la collezione di sospensioni si rifà. Doppia la fonte luminosa, interna ai singoli elementi e inserita nel piatto metallico superiore. Così progettata, la luce esalta il design del cristallo e delle composizioni, facendosi interprete di una ricercatezza che sa essere insieme leggerezza e opulenza. Sorprendenti ed eclettiche le composizioni: a pianta circolare oppure ovale, dalla forma concentrica o dalle geometrie più complesse, come la versione a spirale, perfetta per ambienti molto alti.

An enclosure of luminous reeds dominates the setting, wrapped by the leaves of climbing plants, entirely in Venetian Crystal. The drawings on which the collection of suspension lamps is based date back to the 1980s, stored in the historical archives of Barovier&Toso. The light source is double, inside single elements and inserted in the upper metal plate. The light brings out the refined design of the glass and its compositions, conveying a sense of elegance that is simultaneously lightness and opulence. The compositions are surprising and eclectic: circular or oval, with a concentric form or a more complex geometric arrangement, like the spiral version which is perfect for spaces with very high ceilings.



Modelli e misure <i>Models and sizes</i>		Germogli 7455-00	Germogli 7456-00	Germogli 7457-00	Germogli 7458-00
Peso Weight	80 kg 176,5 lb	50 kg 110 lb	80 kg 176,5 lb	100 kg 220 lb	
Lampadine N. Tipo W max. Bulbs N. Type W max.	6+21 G53+Led 15+0,36 G53+Led 15+0,36	3+18 G53+Led 15+0,36 G53+Led 15+0,36	3+15 G53+Led 15+0,36 G53+Led 15+0,36	6+33 G53+Led 15+0,36 G53+Led 15+0,36	
Dimmerabile Dimmable	D (solo G53)	D (solo G53)	D (solo G53)	D (solo G53)	
Lampadine incluse Bulbs included	G53+Led	G53+Led	G53+Led	G53+Led	
Certificazioni Cerification Marks	ERAC	ERAC	ERAC	ERAC	

Modelli e misure <i>Models and sizes</i>		Germogli 7461-00	Germogli 7462-00
Peso Weight	80 kg 176,5 lb	100 kg 220 lb	
Lampadine N. Tipo W max. Bulbs N. Type W max.	1+25 G53+Led 15+0,36 G53+Led 15+0,36	6+29 G53+Led 15+0,36 G53+Led 15+0,36	
Dimmerabile Dimmable	D (solo G53)	D (solo G53)	
Lampadine incluse Bulbs included	G53+Led	G53+Led	
Certificazioni Cerification Marks	ERAC	ERAC	

Modelli e misure <i>Models and sizes</i>		Germogli 7459-00	Germogli 7460-00
Peso Weight	100 kg 220 lb	100 kg 220 lb	
Lampadine N. Tipo W max. Bulbs N. Type W max.	6+39 G53+Led 15+0,36 G53+Led 15+0,36	4+29 G53+Led 15+0,36 G53+Led 15+0,36	
Dimmerabile Dimmable	D (solo G53)	D (solo G53)	
Lampadine incluse Bulbs included	G53+Led	G53+Led	
Certificazioni Cerification Marks	ERAC	ERAC	

Colori disponibili <i>Available colours</i>				
CC Cristallo <i>Crystal</i>	EK Sabbia <i>Sand</i>	DK Oliva <i>Olive</i>	AK Blu Cadetto <i>Cadet Blue</i>	LQ Bluastro <i>Bluastro</i>
FK Indaco <i>Indigo</i>	CK Pervinca <i>Periwinkle</i>	AT Argento <i>Silver</i>	OO Oro <i>Gold</i>	

Finiture <i>Finishings</i>	
CL Cromo Lucido <i>Polished Chrome</i>	OJ Oro Spazzolato <i>Brushed Gold</i>





Peso Weight	100 kg 220 lb
Lampadine N. Tipo W max. Bulbs N. Type W max.	6+39 G53+Led 15+0,36 G53+Led 15+0,36
Dimmerabile Dimmable	D (solo G53)
Lampadine incluse Bulbs included	G53+Led
Certificazioni Cerification Marks	ERAC

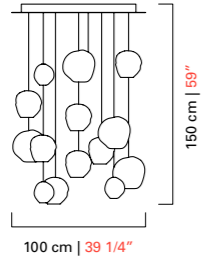
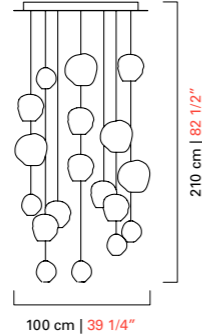
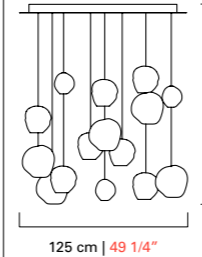
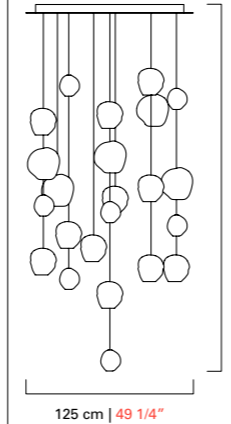

HANAMI

Come in un'opera d'arte moderna lo stesso elemento è ripetuto e moltiplicato quasi all'infinito. Una ripetizione seriale di una semplice forma modulare che genera un volume organico ed omogeneo. Ma in realtà ogni singola bolla non è mai perfettamente identica a sé stessa; la soffiatura e la lavorazione a mano rendono i multipli simili ma mai uguali rendendo unica ogni composizione.

As in a modern artwork, the same element is repeated and multiplied almost infinitely. The reiteration of a simple modular form generates an organic, homogenous volume. Actually, the individual bubbles are never quite the same; the glassblowing technique and handwork make the multiples similar but never equal, meaning that every composition is truly unique.

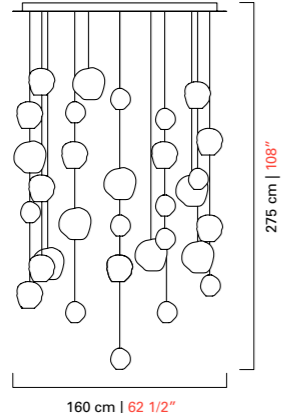

Modelli e misure <i>Models and sizes</i>	Hanami 7295-00	Hanami 7296-00	Hanami 7297-00	Hanami 7298-00
				
Peso Weight	47 kg 103 lb	53 kg 116 lb	75 kg 165 lb	100 kg 220 lb
Lampadine N. Tipo W max. Bulbs N. Type W max.	4+8 G9+GU10 20+20 4+5,3	4+8 G9+GU10 20+20 4+5,3	10+15 G9+GU10 20+20 4+5,3	10+15 G9+GU10 20+20 4+5,3
Dimmerabile Dimmable	D	D	D	D
Lampadine incluse Bulbs included	G9 Led + GU10 Led	G9 Led + GU10 Led	G9 Led + GU10 Led	G9 Led + GU10 Led
Certificazioni Certification Marks				

Modelli e misure <i>Models and sizes</i>	Hanami 7299-00
	
Peso Weight	140 kg 308 lb
Lampadine N. Tipo W max. Bulbs N. Type W max.	13+21 G9+GU10 20+20 4+5,3
Dimmerabile Dimmable	D
Lampadine incluse Bulbs included	G9 Led + GU10 Led
Certificazioni Certification Marks	

Colori disponibili
Available colours



CC
Cristallo
Crystal



IC
Grigio
Grey



EK
Sabbia
Sand



DK
Oliva
Olive



AK
Blu Cadetto
Cadet Blue



LQ
Bluastro
Bluastro



FK
Indaco
Indigo



CK
Pervinca
Periwinkle



VI
Viola
Violet



OO
Oro
Gold

Finiture
Finishings



CL
Cromo Lucido
Polished Chrome

MARTA

Una lampada a sospensione caratterizzata da sfere in cristallo veneziano allineate lavorate con la tradizionale tecnica a "corteccia". La massa vetrosa ancora calda viene fatta rotolare abilmente su di uno stampo piatto a lamelle e poi, successivamente, soffiata per ottenere una superficie irregolare e tridimensionale che ricorda quella della corteccia di un albero.

A suspension lamp featuring aligned spheres of Venetian crystal, crafted with the traditional "corteccia" technique. The hot glass is skilfully turned on a flat lamellar plate and then blown to obtain an irregular three-dimensional surface, resembling the bark of a tree.



Modelli e misure Models and sizes

Marta
5578-00

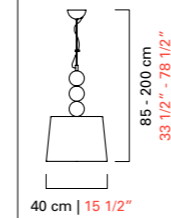

Peso Weight	8 kg 18 lb
Lampadine Bulbs	N. Tipo W max. 1 E27 100 N. Tipo W max. E26 60
Dimmerabile Dimmable	D
Lampadine incluse Bulbs included	
Certificazioni Certification Marks	UL ENEC UL US

Colori disponibili Available colours



CC
Cristallo
Crystal



IC
Grigio
Grey



EK
Sabbia
Sand



DK
Oliva
Olive



AK
Blu Cadetto
Cadet Blue



LQ
Bluastro
Bluastro



FK
Indaco
Indigo



CK
Pervinca
Periwinkle



VI
Viola
Violet



OO
Oro
Gold

Finiture Finishings



CL
Cromo Lucido
Polished Chrome



CN
Cromo Nero
Dark Chrome



OF
Ottone
Spazzolato Fine
Fine Brushed Brass

Paralumi Shades

Esterno: Cotone
External: Cotton



BB
Bianco
White

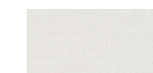

NN
Nero
Black

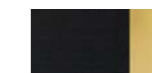



NO
Nero Interno Oro
Black Inner Gold



MATRIOSKA

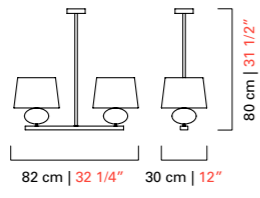
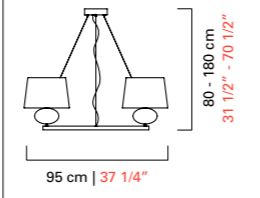

Una collezione caratterizzata da una distribuzione in pianta lineare. Disposti lungo una montatura rettilinea oppure quadrata, i preziosi elementi in cristallo veneziano, chiamati "cipolle" per la loro particolare forma e per la lavorazione a costolature, diventano protagonisti di un'inusuale interpretazione della lampada a sospensione con paralumi.



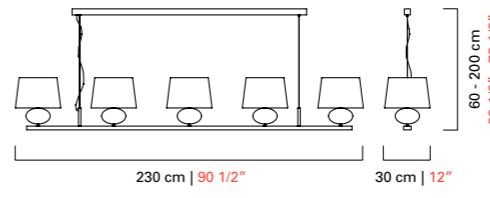



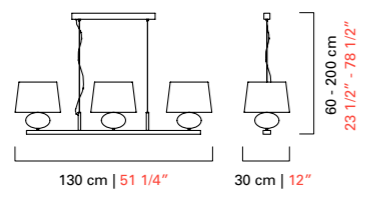
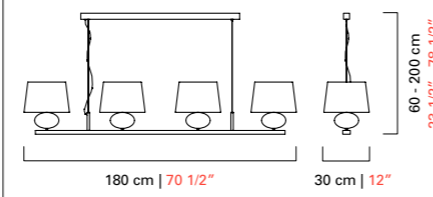







A collection characterized by linear arrangements. Placed along a straight or square fitting, the precious elements in Venetian crystal, known as "cipolle" due to their particular form and ribbed workmanship, become the protagonists of an unusual interpretation of the suspension lamp with shades.



Modelli e misure <i>Models and sizes</i>	Matrioska 7097/02	Matrioska 7098-04
		
Peso Weight	6 kg 13 lb	14 kg 31 lb
Lampadine N. Tipo W max. Bulbs N. Type W max.	2 E27 60 E26 60	4 E27 60 E26 60
Dimmerabile Dimmable	D	D
Lampadine incluse Bulbs included		
Certificazioni Cerification Marks		

Modelli e misure <i>Models and sizes</i>	Matrioska 7097-05
	
Peso Weight	15 kg 33 lb
Lampadine N. Tipo W max. Bulbs N. Type W max.	5 E27 60 E26 60
Dimmerabile Dimmable	D
Lampadine incluse Bulbs included	
Certificazioni Cerification Marks	

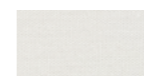
Modelli e misure <i>Models and sizes</i>	Matrioska 7097-03	Matrioska 7097-04
		
Peso Weight	9 kg 20 lb	12 kg 26 lb
Lampadine N. Tipo W max. Bulbs N. Type W max.	3 E27 60 E26 60	4 E27 60 E26 60
Dimmerabile Dimmable	D	D
Lampadine incluse Bulbs included		
Certificazioni Cerification Marks		

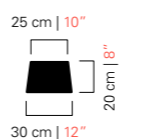
Colori disponibili <i>Available colours</i>	 CC Cristallo <i>Crystal</i>	 IC Grigio <i>Grey</i>	 EK Sabbia <i>Sand</i>	 DK Oliva <i>Olive</i>	 AK Blu Cadetto <i>Cadet Blue</i>
	 LQ Bluastro <i>Bluastro</i>	 FK Indaco <i>Indigo</i>	 CK Pervinca <i>Periwinkle</i>	 VI Viola <i>Violet</i>	 OO Oro <i>Gold</i>
Finiture <i>Finishings</i>	 CL Cromo Lucido <i>Polished Chrome</i>	 CN Cromo Nero <i>Dark Chrome</i>	 OF Ottone Spazzolato Fine <i>Fine Brushed Brass</i>		
	 BB Bianco <i>White</i>	 NN Nero <i>Black</i>	 NO Nero Interno Oro <i>Black Inner Gold</i>		
	 Paralumi Shades Esterno: Cotone <i>External: Cotton</i>				

MEDINA

Una collezione formosa, con dimensioni generose dalle linee quasi boteriane.
Il collare metallico ed i paralumi fuori scala caratterizzano l'intera linea.

A shapely collection with generous dimensions whose design recalls somehow Botero's drawings. The metal neck and the oversize shades are distinctive of the entire line.



Modelli e misure Models and sizes

	Medina 5684-03	Medina 5684-05
Peso Weight	23 kg 51 lb	32 kg 70 lb
Lampadine Bulbs	N. Tipo W max. 3 E27 100	N. Tipo W max. 5 E27 100
Dimmerabile Dimmable	D	D
Lampadine incluse Bulbs included		
Certificazioni Certification Marks		

Colori disponibili Available colours



CC
Cristallo
Crystal



IC
Grigio
Grey



EK
Sabbia
Sand



DK
Oliva
Olive



AK
Blu Cadetto
Cadet Blue



LQ
Bluastro
Bluastro



FK
Indaco
Indigo



CK
Pervinca
Periwinkle



VI
Viola
Viola



OO
Oro
Gold

Finiture Finishings



CL
Cromo Lucido
Polished Chrome



CN
Cromo Nero
Dark Chrome



OF
Ottone
Spazzolato Fine
Fine Brushed Brass

Paralumi Shades

Esterno: Cotone
External: Cotton



BB
Bianco
White



NN
Nero
Black



NO
Nero Interno Oro
Black Inner Gold

MIDTOWN

Midtown è una collezione che esprime la monumentalità del cristallo veneziano, ispirandosi all'architettura del primo '900 e ai grattacieli di Manhattan degli anni '20 e '30. Il design si distingue per una geometria scomposta, creata dall'accostamento di lastre di cristallo di diverse dimensioni, realizzate in piastra. Le superfici presentano scanalature verticali e orizzontali, conferendo al cristallo una texture zigrinata, in grado di conservare l'intensità della fonte luminosa con un leggero effetto diffuso. La moltitudine di piani sfalsati produce una connotazione decorativa che sfrutta la geometria elementare e lo spazio, attraverso un gioco di luci ed ombre, rifrazioni e schermature.

A tribute to architectural grandeur, Midtown captures the expressive power of Venetian crystal, inspired by early 20th century architecture and the iconic Manhattan skyline of the 1920s and 30s. Its design is defined by a fragmented geometry, composed of juxtaposed crystal panels of varying dimensions, precision-cut to create a sculptural effect. The surfaces feature subtle vertical and horizontal fluting, giving the glass a refined ribbed texture that retains and diffuses light with a soft, atmospheric glow. The interplay of staggered planes reinforces Midtown's decorative identity, using elemental geometry and spatial depth to create a dynamic dialogue of light and shadow, refraction and diffusion.

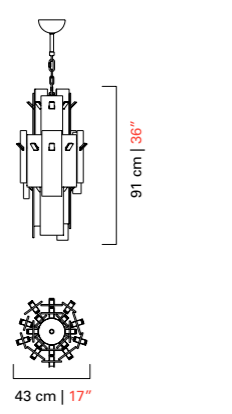
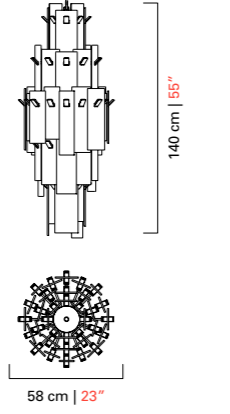
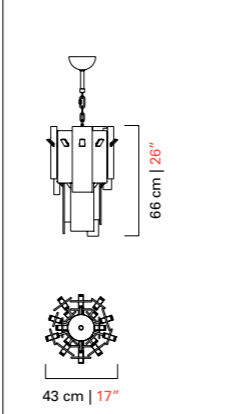
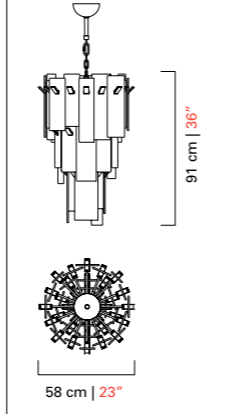

Modelli e misure <i>Models and sizes</i>	Midtown 7585-00	Midtown 7586-00	Midtown 7587-00	Midtown 7588-00
				
Peso Weight	35 kg 77 lb	68 kg 150 lb	25 kg 55 lb	43 kg 95 lb
Lampadine N. Tipo W max. Bulbs N. Type W max.	26 Led 1,5 Led 1,5	52 Led 1,5 Led 1,5	18 Led 1,5 Led 1,5	34 Led 1,5 Led 1,5
Dimmerabile Dimmable	D	D	D	D
Lampadine incluse Bulbs included	Led	Led	Led	Led
Certificazioni Certification Marks				

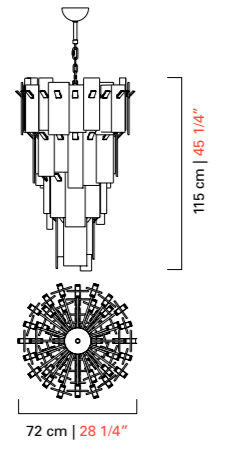
Modelli e misure <i>Models and sizes</i>	Midtown 7589-00
	
Peso Weight	75 kg 165 lb
Lampadine N. Tipo W max. Bulbs N. Type W max.	55 Led 1,5 Led 1,5
Dimmerabile Dimmable	D
Lampadine incluse Bulbs included	Led
Certificazioni Certification Marks	

Colori disponibili
Available colours



CC
Cristallo
Crystal

Finiture
Finishings



CL
Cromo Lucido
Polished Chrome



NS
Nickel Spazzolato
Brushed Nickel



VG
Verniciato Bianco
Painted White

NEW FELCI

Per immergersi in una suggestiva atmosfera dallo stile Déco, ammiccando al gusto glamour degli anni '20 e '30. Il fascino di una cascata di luce composta da brillanti e voluttuose foglie in cristallo veneziano delicatamente arricciate alle estremità.

For a plunge into an evocative Déco mood that takes its cue from the glamour of the 1920s and 1930s. The charm of a cascade of light composed of sparkling and voluptuous leaves of Venetian crystal, delicately curled at the extremities.



Modelli e misure <i>Models and sizes</i>	New Felci 7240-00	New Felci 7241-00	New Felci 7242-00	New Felci 7243-00
Peso Weight	28 kg 62 lb	60 kg 132 lb	100 kg 220 lb	94 kg 207 lb
Lampadine N. Tipo W max. Bulbs N. Type W max.	5 E14 40 E12 40	8+4 E14+E14 60+40 E12+E12 5+5	18+4 E14+E14 60+40 E12+E12 5+5	16+2 E14+G9 40+20 E12+G9 5+20
Dimmerabile Dimmable	D	D	D	D
Lampadine incluse Bulbs included				G9 Led
Certificazioni Cerification Marks	ERAC CCC	ERAC CCC cUL US	ERAC cUL US	ERAC CCC cUL US

Colori disponibili
Available colours



CC
Cristallo
Crystal

Finiture
Finishings



CL
Cromo Lucido
Polished Chrome



OG
Oro Galvanizzato
Galvanized Gold

Modelli e misure <i>Models and sizes</i>	New Felci 7246-00
Peso Weight	150 kg 330 lb
Lampadine N. Tipo W max. Bulbs N. Type W max.	28+2 E14+G9 40+20 E12+G9 5+20
Dimmerabile Dimmable	D
Lampadine incluse Bulbs included	G9 Led
Certificazioni Cerification Marks	ERAC cUL US



OPÉRA



Philippe Nigro

Opéra è una collezione di lampade ispirata all'Opéra Garnier, in cui l'elemento principale è la lavorazione del rostrato. La forma cilindrica va ad enfatizzare il motivo ornamentale, moltiplicando gli angoli di incidenza dei raggi luminosi e creando un fitto involuppo di punte tridimensionali. Alle creazioni in Cristallo Veneziano sono abbinati elementi metallici dalla silhouette molto affine, che circondano e sostengono i corpi luminosi. Le sospensioni Opéra sono disponibili in diverse varianti dimensionali, per sposare progetti di interior design di natura e portata differente: dagli spazi domestici fino ai grandi ambienti di rappresentanza e contract, dove è possibile realizzare delle vere e proprie installazioni personalizzate, con composizioni asimmetriche e multiformi.

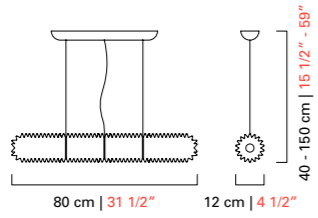
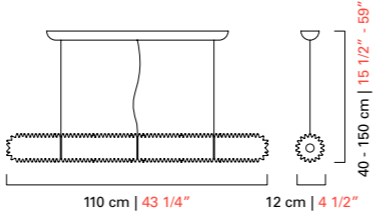
Opéra is a collection of lamps inspired by the Opéra Garnier, where the main feature is the rostrato. The cylindrical form underscores the ornamental motif, multiplying the angles of impact of beams of light and creating a dense wrapping of three-dimensional points. The creations in Venetian Crystal are joined by metal parts with a very similar silhouette, which surround and support the luminous volumes: completely different textures, sharing a specific inspiration in their shapes and substance. The Opéra suspension lamps are available in different sizes, ready to be utilized in interior design projects of different types and scales: from residential spaces to contract applications, where it is possible to organize true custom installations, with asymmetrical and multiform compositions.

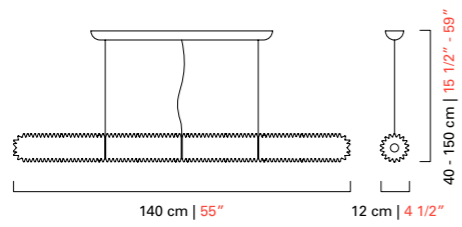

Modelli e misure <i>Models and sizes</i>		Opéra 7386-00	Opéra 7387-00
			
Peso Weight		12 kg 26 lb	15 kg 33 lb
Lampadine Bulbs	N. Tipo W max. N. Type W max.	1 Strip Led 30 30	1 Strip Led 38 38
Dimmerabile Dimmable		D	D
Lampadine incluse Bulbs included		Strip Led	Strip Led
Certificazioni Cerification Marks			

Modelli e misure <i>Models and sizes</i>		Opéra 7388-00
		
Peso Weight		18 kg 40 lb
Lampadine Bulbs	N. Tipo W max. N. Type W max.	1 Strip Led 45 45
Dimmerabile Dimmable		D
Lampadine incluse Bulbs included		Strip Led
Certificazioni Cerification Marks		

Colori disponibili
Available colours

CC
 Cristallo
Crystal
Finiture
Finishings

NJ
 Nickel Nero
 Spazzolato
*Brushed Black
 Nickel*

OJ
 Oro Spazzolato
Brushed Gold

PADMA

Collezione disegnata per esprimere armonia, sintesi tra le parti, sinergia tra contrasti. A confrontarsi sono innovazione e tradizione, attraverso il rapporto tra design e tecniche di lavorazione, attinte allo storico patrimonio conoscitivo dell'azienda. Insolite commistioni generano un suggestivo dialogo tra elementi racchiusi l'uno nell'altro, diversi tra loro per forma, cromia, lavorazione, ma fortemente connessi dal design dell'oggetto.

This collection is designed to express harmony, a synthesis of parts, a synergy of contrasts. The balance of innovation and tradition, through the relationship between design and techniques of workmanship, drawing on the company's heritage of know-how. Unusual mixtures generate an evocative dialogue between parts nestled one inside the other, different in form, hue, workmanship, but forcefully connected by the design of the object.



Modelli e misure
Models and sizes

	Padma 7379-00	Padma 7381-00	Padma 7383-00	Padma 7384-00
Peso Weight	7 kg 15 lb	7 kg 15 lb	7 kg 15 lb	22 kg 48 lb
Lampadine N. Tipo W max. Bulbs N. Type W max.	1 Led 10 1 Led 10	1 Led 10 1 Led 10	1 Led 10 1 Led 10	3 Led 10 3 Led 10
Dimmerabile Dimmable	D	D	D	D
Lampadine incluse Bulbs included	Led	Led	Led	Led
Certificazioni Cerification Marks				

Colori disponibili
Available colours

Diffusore Bianco sfumato o
Diffusore Grigio Sfumato
*Shaded White Diffuser or
Shaded Grey Diffuser*

Il colore si riferisce solo al finalino
*The colour refers only to the
final element*

BB
 Bianco/ Bianco
White/ White

BC
 Bianco/ Cristallo
White/ Crystal

IN
 Bianco/ Grigio
White/ Grey

EW
 Bianco/ Sabbia
White/ Sand

BP
 Bianco/ Oliva
White/ Olive

BU
 Bianco/ Bluastro
White/ Bluastro

FB
 Bianco/ Indaco
White/ Indigo

CP
 Bianco/ Pervinca
White/ Periwinkle

BO
 Bianco/ Oro
White/ Gold

BN
 Bianco/ Nero
White/ Black

IT
 Grigio/ Cristallo
Grey/ Crystal

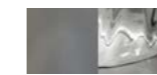
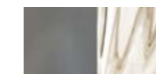
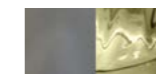
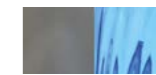
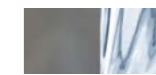
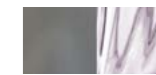
YG
 Grigio/ Bianco
Grey/ White

IC
 Grigio/ Grigio
Grey/ Grey

FS
 Grigio/ Sabbia
Grey/ Sand

FR
 Grigio/ Oliva
Grey/ Olive

DJ
 Grigio/ Bluastro
Grey/ Bluastro

FT
 Grigio/ Indaco
Grey/ Indigo

FQ
 Grigio/ Pervinca
Grey/ Periwinkle

GG
 Grigio/ Oro
Grey/ Gold

EC
 Grigio/ Nero
Grey/ Black
Finiture
Finishings

NJ
 Nickel nero
 spazzolato
*Brushed Black
 Nickel*

OJ
 Oro Spazzolato
Brushed Gold

PALMETTE

Una collezione che si distingue per la preziosità delle lavorazioni, rigorosamente realizzate artigianalmente e frutto di una ricerca stilistica che attinge alla storia per darne una interpretazione in chiave contemporanea. Ventagli in foglie di cristallo, sovrapposti a formare due, tre e quattro livelli per una rilettura intrigante dello stile déco.

A collection that stands out for precious workmanship rigorously done by hand, result of stylistic research that draws on history, granting it a contemporary interpretation. Fans of crystal leaves, placed to form two, three and four levels, for an intriguing take on Art Deco.



Modelli e misure <i>Models and sizes</i>	Palmette 7505-00	Palmette 7506-00	Palmette 7507-00	Palmette 7508-00
Peso Weight	19 kg 42 lb	30 kg 66 lb	60 kg 132 lb	45 kg 99 lb
Lampadine N. Tipo W max. Bulbs N. Type W max.	6 E27 60 E26 40	6 E27 60 E26 40	16 E27 60 E26 40	11 E27 60 E26 40
Dimmerabile Dimmable	D	D	D	D
Lampadine incluse Bulbs included				
Certificazioni Cerification Marks	ERC	ERC	ERC	ERC

Modelli e misure <i>Models and sizes</i>	Palmette 7513-00
Peso Weight	60 kg 132 lb
Lampadine N. Tipo W max. Bulbs N. Type W max.	15 E27 60 E26 40
Dimmerabile Dimmable	D
Lampadine incluse Bulbs included	
Certificazioni Cerification Marks	ERC

Modelli e misure <i>Models and sizes</i>	Palmette 7509-00	Palmette 7510-00	Palmette 7511-00	Palmette 7512-00
Peso Weight	27 kg 59 lb	110 kg 242 lb	27 kg 59 lb	60 kg 132 lb
Lampadine N. Tipo W max. Bulbs N. Type W max.	6 E14 60 E12 40	28 E27 60 E26 40	6+6 E14 60+40 E12 40	17 E27 60+40 E26 40
Dimmerabile Dimmable	D	D	D	D
Lampadine incluse Bulbs included				
Certificazioni Cerification Marks	ERC	ERC	ERC	ERC

Colori disponibili
Available colours



CC
Cristallo
Crystal

Finiture
Finishings



CL
Cromo Lucido
Polished Chrome



OG
Oro Galvanizzato
Galvanized Gold

PALMYRA

Fabio Calvi | Paolo Brambilla

Una sospensione molto leggera, caratterizzata da linee sinuose, in grado di impreziosire e di illuminare qualunque ambiente. È composta da bracci sovrapposti dal profilo curvilineo, dai quali pendono molteplici elementi di vetro ritorto realizzati con la stessa lavorazione dei "pastorali" dell'antica tradizione vetraria muranese.

Palmyra is a very light suspension, characterized by sinuous lines, able to embellish and illuminate any environment. It is composed by overlapped arms with curved profiles, from which hang twisted crystal elements, made following the "pastoral" processing of the ancient Murano glass tradition.

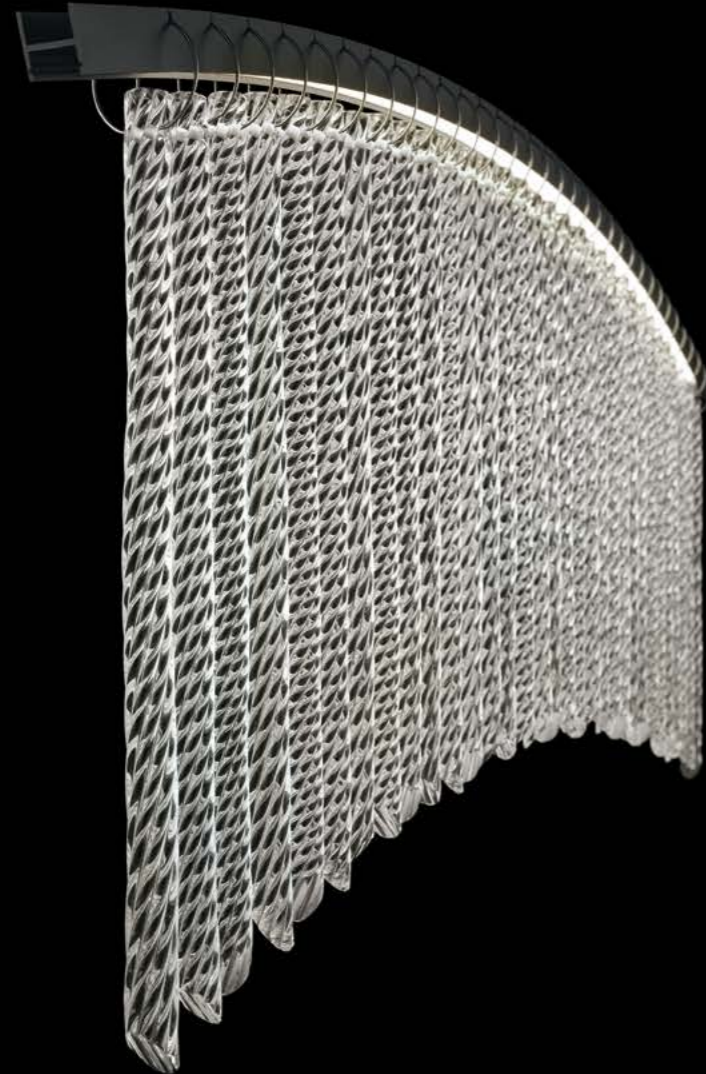

Modelli e misure <i>Models and sizes</i>	Palmyra 7270-00	Palmyra 7271-00
Peso Weight	19 kg 42 lb	55 kg 121 lb
Lampadine N. Tipo W max. Bulbs N. Type W max.	1 Strip Led 60 60	3 Strip Led 60 60
Dimmerabile Dimmable		
Lampadine incluse Bulbs included	Strip Led	Strip Led
Certificazioni Certification Marks		

Modelli e misure <i>Models and sizes</i>	Palmyra 7274-00
Peso Weight	78 kg 172 lb
Lampadine N. Tipo W max. Bulbs N. Type W max.	1+2+1 Strip Led 40+60+80 40+60+80
Dimmerabile Dimmable	
Lampadine incluse Bulbs included	Strip Led
Certificazioni Certification Marks	

Modelli e misure <i>Models and sizes</i>	Palmyra 7272-00	Palmyra 7273-00
Peso Weight	55 kg 121 lb	72 kg 158 lb
Lampadine N. Tipo W max. Bulbs N. Type W max.	1+1+1 Strip Led 40+60+80 40+60+80	4 Strip Led 60 60
Dimmerabile Dimmable		
Lampadine incluse Bulbs included	Strip Led	Strip Led
Certificazioni Certification Marks		

Colori disponibili <i>Available colours</i>									
CC Cristallo <i>Crystal</i>									
Finiture <i>Finishings</i>	<table border="0"> <tr> <td></td> <td></td> <td></td> <td></td> </tr> <tr> <td>AI Anodizzato Argento/Anelli Inox <i>Anodized Silver/Inox Rings</i></td> <td>AO Anodizzato Argento/ Anelli Oro Galvanizzato <i>Anodized Silver/ Galvanized Gold Ring</i></td> <td>NI Anodizzato Nero/ Anelli Inox <i>Anodized Black/Inox Rings</i></td> <td>NG Anodizzato Nero/ Anelli Oro Galvanizzato <i>Anodized Black/ Galvanized Gold Rings</i></td> </tr> </table>					AI Anodizzato Argento/Anelli Inox <i>Anodized Silver/Inox Rings</i>	AO Anodizzato Argento/ Anelli Oro Galvanizzato <i>Anodized Silver/ Galvanized Gold Ring</i>	NI Anodizzato Nero/ Anelli Inox <i>Anodized Black/Inox Rings</i>	NG Anodizzato Nero/ Anelli Oro Galvanizzato <i>Anodized Black/ Galvanized Gold Rings</i>
AI Anodizzato Argento/Anelli Inox <i>Anodized Silver/Inox Rings</i>	AO Anodizzato Argento/ Anelli Oro Galvanizzato <i>Anodized Silver/ Galvanized Gold Ring</i>	NI Anodizzato Nero/ Anelli Inox <i>Anodized Black/Inox Rings</i>	NG Anodizzato Nero/ Anelli Oro Galvanizzato <i>Anodized Black/ Galvanized Gold Rings</i>						

PANDORA

Regala leggerezza ed un aspetto fiabesco agli interni grazie ai bracci in cristallo veneziano che sembrano fluttuare nell'aria. Il suo aspetto simile a quello di una medusa crea divertenti giochi di luce che donano profondità agli ambienti, ed il suo paralume di dimensioni importanti genera un'illuminazione omogenea ed elegante.

Interiors take on a light, fairy-tale image thanks to arms of Venetian crystal that seem to float in the air. The resemblance to a jellyfish suggests playful games of light that add depth to spaces, while the large shade generates uniform, elegant light.



Modelli e misure Models and sizes

	Pandora 5675-05	Pandora 5675-08	Pandora 5675-10
Peso Weight	6 kg 13 lb	10 kg 22 lb	14 kg 31 lb
Lampadine Bulbs	N. Tipo W max. 5+1 E14+Led 60+1,2 E12+Led 60+1,2	8+1 E14+Led 60+1,2 E12+Led 60+1,2	10+1 E14+Led 60+1,2 E12+Led 60+1,2
Dimmerabile Dimmable	D E14	D E14	D E14
Lampadine incluse Bulbs included	Led	Led	Led
Certificazioni Certification Marks			

Colori disponibili Available colours



CC
Cristallo
Crystal



IC
Grigio
Grey



EK
Sabbia
Sand



DK
Oliva
Olive



AK
Blu Cadetto
Cadet Blue



LQ
Bluastro
Bluastro



FK
Indaco
Indigo



CK
Pervinca
Periwinkle



VI
Viola
Violet



OO
Oro
Gold

Finiture Finishings



CL
Cromo Lucido
Polished Chrome



CN
Cromo Nero
Dark Chrome

Paralumi Shades

Esterno: Cotone
External: Cotton



40 cm | 15 1/2"



60 cm | 23 1/2"



80 cm | 31 1/2"



BB
Bianco
White



NN
Nero
Black



NO
Nero Interno Oro
Black Inner Gold

PERSEUS

Marcel Wanders

Una sospensione che si presenta come una strabiliante esplosione di cristallo veneziano, sapientemente equilibrata nei volumi, nell'alternarsi delle diverse cromie, nel gioco asimmetrico dei bracci. Perseus è composta da un gran numero di elementi in cristallo che rappresentano quasi un compendio delle tecniche vetrarie studiate e sviluppate da Barovier&Toso nel corso della sua lunga storia, qui reinterpretate, accostate e mescolate in modo sovversivo rispetto ai canoni della classicità.

This suspension looks like a dazzling explosion of Venetian crystal, carefully balanced in volume, in the alternation of different colours, in the asymmetrical game of the arms. Perseus is composed of a large number of crystal elements that represent a compendium of the glassmaking techniques studied and developed by Barovier&Toso in the course of its long history, here reinterpreted, paired, and mixed in a subversive way with respect to the canons of classicism.



Modelli e misure Models and sizes

	Perseus 7265-00	Perseus 7310-00	Perseus 7311-00
Peso Weight	40 kg 88 lb	4 kg 9 lb	7 kg 15 lb
Lampadine Bulbs	N. Tipo W max. 15 G4 5	1 E14 40 E12 40	1 E14 40 E12 40
Dimmerabile Dimmable		D	D
Lampadine incluse Bulbs included	G4 Led		
Certificazioni Certification Marks	UL ENEC c UL US	UL ENEC c UL US	UL ENEC c UL US

Colori disponibili Available colours



***WP**
Cristallo/ Grigio/
Brown/ Cognac/
Bianco
Crystal/ Grey/
Brown/ Cognac/
White
*Solo 7265
Only 7265



***WR**
Cristallo/ Bianco/
Cognac/ Bluastro
Crystal/ White/
Cognac/ Bluastro
*Solo 7265
Only 7265



***WZ**
Cristallo/
Cedro liquido/
Acquamare/
Grigio/ Bianco
Crystal/
Liquid Citron/
Aquamarine/
Grey/ White
*Solo 7265
Only 7265



***WQ**
Bianco/ Cristallo/
Grigio/
Cedro Liquido
White/ Crystal/
Grey/ Liquid Citron
*Solo 7310 / 7311
Only 7310 / 7311



***WS**
Bianco/ Cristallo/
Cognac/ Brow/
Cognac/ Brown
*Solo 7310 / 7311
Only 7310 / 7311

Finiture Finishings



CL
Cromo Lucido
Polished Chrome

PIGALLE

Tradizione ed innovazione si fondono in questa collezione ispirata alla Belle Époque. Si caratterizza per eleganza e linee sinuose senza risultare eccessiva ed ostentata. Eloquente per raffinatezza e grazia alterna linee semplici, dettagli curvi e lavorazioni tradizionali.

Tradition and innovation blend in this collection inspired by the Belle Époque. It stands out for its elegant, sinuous lines, without ever seeming excessive or ostentatious. With its eloquent refinement and grace, it mixes simple lines, curved details and traditional workmanship.



Modelli e misure Models and sizes

	Pigalle 5692-00	Pigalle 5693-00
Peso Weight	11 kg 24 lb	8 kg 18 lb
Lampadine Bulbs	N. Tipo W max. 6 E14 60 E12 60	N. Tipo W max. 3 E14 60 E12 60
Dimmerabile Dimmable	D	D
Lampadine incluse Bulbs included		
Certificazioni Certification Marks		

Colori disponibili Available colours



BC
Bianco/ Cristallo
White/ Crystal

Finiture Finishings



CL
Cromo Lucido
Polished Chrome



CN
Cromo Nero
Dark Chrome







OJ
Oro Spazzolato
Brushed Gold

PIUME

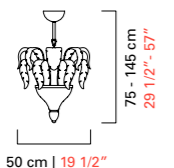
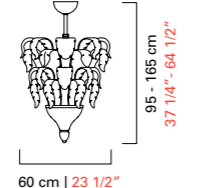
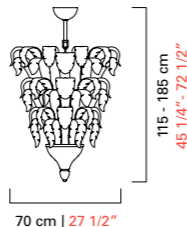
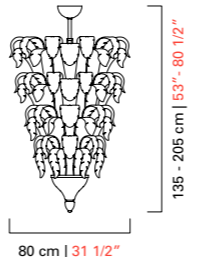

Riprese dai disegni degli anni '20 e '30 del nostro archivio storico, queste sospensioni sono un omaggio allo stile Déco. Con le loro ricche piume evocano ambientazioni lussuose e ricercate. Adatte ad ambienti estremamente decorati come anche, per contrasto, ad interni più minimali.

Resumed from drawings of the 20ies and 30ies from our historical archive, these suspensions pay a tribute to the Déco era. With their rich feathers they evoke luxurious and refined settings. Perfect for extremely decorated ambiences as well as, playing with contrasts, for more minimal interior design projects.

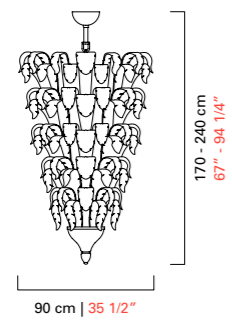

Modelli e misure <i>Models and sizes</i>	Piume 5393-00	Piume 5394-00	Piume 5395-00	Piume 5396-00
	 75 - 145 cm 29 1/2" - 57" 50 cm 19 1/2"	 95 - 165 cm 37 1/4" - 64 1/2" 60 cm 23 1/2"	 115 - 185 cm 45 1/4" - 72 1/2" 70 cm 27 1/2"	 135 - 205 cm 53" - 80 1/2" 80 cm 31 1/2"
Peso Weight	18 kg 40 lb	48 kg 106 lb	57 kg 125 lb	80 kg 176 lb
Lampadine N. Tipo W max. Bulbs N. Type W max.	4 E14 60 E12 60	8 E14 40 E12 40	8+5 E27+E14 60+40 E26+E12 60+40	13+4 E27+E14 60 E26+E12 60
Dimmerabile Dimmable	D	D	D	D
Lampadine incluse Bulbs included				
Certificazioni Certification Marks				

Colori disponibili
Available colours**OB**
Oro Beige
Beige Gold**Finiture**
Finishings**OG**
Oro Galvanizzato
Galvanized Gold

Modelli e misure <i>Models and sizes</i>	Piume 5397-00
	 170 - 240 cm 67" - 94 1/4" 90 cm 35 1/2"
Peso Weight	100 kg 220 lb
Lampadine N. Tipo W max. Bulbs N. Type W max.	18+4 E27+E14 60+40 E26+E12 60+40
Dimmerabile Dimmable	D
Lampadine incluse Bulbs included	
Certificazioni Certification Marks	

PUNK

Roberto Lazzeroni

Poesia e leggerezza convivono in questa dirompente collezione, ispirata alle espressioni stilistiche a cavallo tra gli anni '50 e gli anni '60. Roberto Lazzeroni interpreta il dialogo tra tradizione e modernità e costruisce una sua lettura, poeticamente connessa a quell'immaginario familiare. Come schegge, le formelle in cristallo veneziano coniugano ironia e rigore. Ancorate manifestamente alla struttura ad anello, schermano la fonte luminosa e stabiliscono rapporti proporzionali di notevole impatto.

Poetry and lightness coexist in this bold, novel collection that takes its inspiration from the stylistic expressions of the 1950s and 1960s. Roberto Lazzeroni interprets the dialogue between tradition and modernity, building an interpretation poetically connected to this familiar imagery. Like splinters, the tiles in Venetian Crystal combine irony and rigor. Visibly anchored to the structural ring, they screen the light source and establish proportional relationships of remarkable impact.

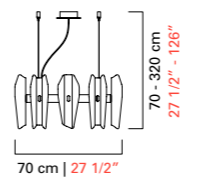
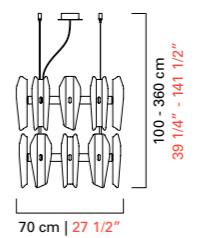
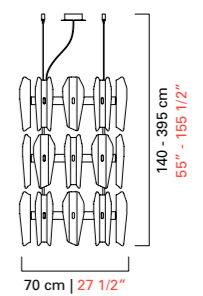

Modelli e misure Models and sizes

	Punk 7450-00	Punk 7451-00	Punk 7452-00
			
Peso Weight	22 kg 48,5 lb	45 kg 99 lb	67 kg 147,5 lb
Lampadine Bulbs	N. Tipo W max. 24 G9 4	N. Tipo W max. 48 G9 4	N. Tipo W max. 72 G9 4
Dimmerabile Dimmable	D	D	D
Lampadine incluse Bulbs included	G9	G9	G9
Certificazioni Certification Marks	ETC	ETC	ETC

Colori disponibili Available colours



CC
Cristallo
Crystal



SF
Smeraldo / Fumé
Emerald / Smoke

Finiture Finishings

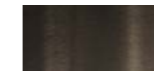

NJ
Nickel Nero
Spazzolato
Brushed Black
Nickel



OJ
Oro Spazzolato
Brushed Gold



REX

Un grande fiore che fluttua nell'aria. Petali preziosi ed elaborati che grazie all'utilizzo della tecnica della "rugiada" sembrano dei merletti fatti a mano. Sospensioni spesso scelte all'inizio del '900 per grandi progetti di navi da crociera e alberghi di lusso sono ancora oggi dei pezzi unici capaci di donare un tocco retrò anche a progetti più contemporanei.

A large flower that floats in the air. Precious and elaborated petals that thanks to the "rugiada" technique seem handmade laces. These suspensions lamps were very common at the beginning of the 20th century in big cruises and luxury hotels projects but nowadays they are still unique pieces capable to give a retrò touch also to more contemporary projects.

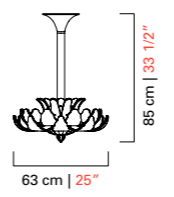
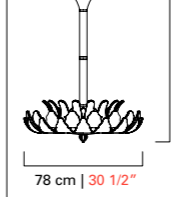

Modelli e misure Models and sizes

	Rex 5359-00	Rex 5360-00
		
Peso Weight	22 kg 48 lb	32 kg 70 lb
Lampadine Bulbs	N. Tipo W max. 9+2 E14 60+40 N. Type W max. E12 60+40	12 E14 60 E12 60
Dimmerabile Dimmable	D	D
Lampadine incluse Bulbs included		
Certificazioni Certification Marks		

Colori disponibili Available colours



CR
Cristallo Rugiada
Crystal Rugiada



GR
Champagne Rugiada
Champagne Rugiada



OR
Oro Rugiada
Gold Rugiada

Finiture Finishings



OF
Ottone Spazzolato Fine
Fine Brushed Brass

ROBIN

Interpretazione moderna dell'archetipo della lanterna. Il disegno è pulito, minimale e rigoroso ma anche immediato: dà vita ad una forma che univocamente ci rammenta la remota foggia e l'antica funzione dell'iconica lampada. Le ali metalliche formano una maglia strutturale che abbraccia il diffusore in vetro opalino che illuminato genera un effetto luminoso caldo e soffuso.

A modern interpretation of the lantern archetype. The design is clean, minimal and rigorous, but also immediate: it generates a form that instantly reminds us of the age-old shape and original function of the iconic lamp. The metal wings form a structure that embraces the diffuser in opaline glass, which spreads a warm, soft glow into the space.



Modelli e misure Models and sizes

	Robin 7280-00	Robin 7281-00
Peso Weight	15 kg 33 lb	17 kg 37 lb
Lampadine Bulbs	N. Tipo/Type W max. 1+6+1 Led + G4 + Strip Led 2,3+5+1,9	1+6+1 Led + G4 + Strip Led 2,3+5+1,9
Dimmerabile Dimmable		
Lampadine incluse Bulbs included	Led + G4 Led + Strip Led	Led + G4 Led + Strip Led
Certificazioni Certification Marks	ERAC	ERAC

Colori disponibili Available colours



CC
Cristallo
Crystal



IC
Grigio
Grey



EK
Sabbia
Sand



DK
Oliva
Olive



AK
Blu Cadetto
Cadet Blue



LQ
Bluastro
Bluastro



FK
Indaco
Indigo



CK
Perivinka
Periwinkle



VI
Viola
Violet



OO
Oro
Gold

Finiture Finishings



CL
Cromo Lucido
Polished Chrome

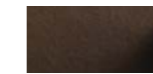

ZO
Bronzo Satinato
Satinized Bronze



SPADE

Collezione di sospensioni ispirata ai fiori e alla natura che si contraddistingue per il suo delicato design a forma di corolla, realizzata con la tecnica della "rugiada" che dona un raffinato effetto ricamato. Due o tre livelli di petali si sovrappongono come a formare dei fiori schiusi, sospesi nell'aria.

A collection of suspensions with an accent on flowers and nature, which stands out for its delicate design in the form of a corolla, made with the "rugiada" technique to create a refined embroidered look. Two or three levels of petals overlap to form the image of a blossoming flower, suspended in the air.

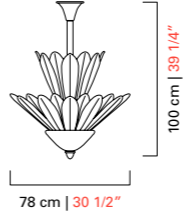
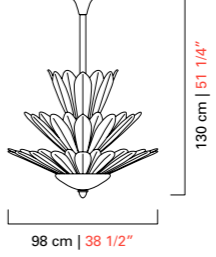

Modelli e misure Models and sizes

	Spade 6746-00	Spade 6743-00
		
Peso Weight	53 kg 117 lb	90 kg 198 lb
Lampadine Bulbs	N. Tipo W max. 9+2 E14 60+40	N. Tipo W max. 15+3 E14 60+40
Dimmerabile Dimmable	D	D
Lampadine incluse Bulbs included		
Certificazioni Certification Marks		

Colori disponibili Available colours



CR
Cristallo Rugiada
Crystal Rugiada

Finiture Finishings



CL
Cromo Lucido
Polished Chrome



OG
Oro Galvanizzato
Galvanized Gold







OF
Ottone
Spazzolato Fine
Fine Brushed Brass

SPINN

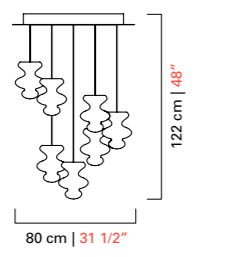
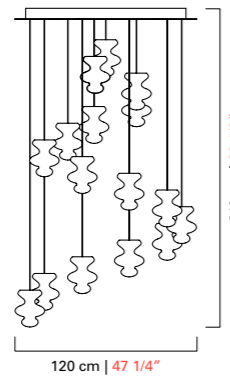
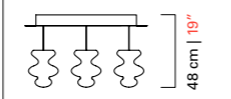
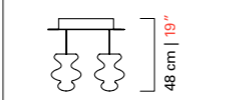
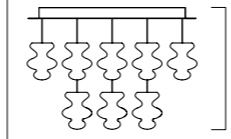
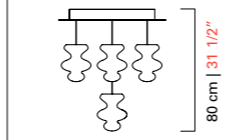

La "bambolina" è un elemento utilizzato nei lampadari della tradizione muranese. Nella collezione Spinn, tante bamboline disposte a spirale e illuminate dall'interno formano un vortice luminoso che decora l'ambiente con disegni e ombre, grazie alla tipica lavorazione del vetro detta "a balotòn".

The "bambolina" is an element used in chandeliers of the Muranese tradition. Spirally arranged and internally lit form a bright swirl which adorns the setting with designs and shadows thanks to the typical glass working called "a balotòn" (giving a cross-relief effect on glass).

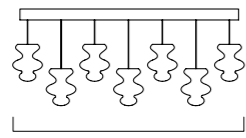
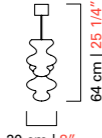

Modelli e misure Models and sizes	Spinn 7218-00	Spinn 7219-00	Spinn 7220-00	Spinn 7221-00
			 	 
Peso Weight	25 kg 55 lb	55 kg 121 lb	23 kg 51 lb	45 kg 99 lb
Lampadine N. Tipo W max. Bulbs N. Type W max.	5+7 GU5.3+G4 7+5	9+16 GU5.3+G4 7+5	5+6 GU5.3+G4 7+5	8+15 GU5.3+G4 7+5
Dimmerabile Dimmable	D	D	D	D
Lampadine incluse Bulbs included	GU5.3 Led + G4 Led	GU5.3 Led + G4 Led	GU5.3 Led + G4 Led	GU5.3 Led + G4 Led
Certificazioni Certification Marks				

Colori disponibili
Available coloursCC
Cristallo
CrystalCG
Cognac
CognacOO
Oro
Gold**Finiture**
FinishingsCL
Cromo Lucido
Polished Chrome

Modelli e misure Models and sizes	Spinn 7222-00
	 
Peso Weight	14 kg 31 lb
Lampadine N. Tipo W max. Bulbs N. Type W max.	6+7 GU5.3+G4 7+5
Dimmerabile Dimmable	D
Lampadine incluse Bulbs included	GU5.3 Led + G4 Led
Certificazioni Certification Marks	

SWING

L'elemento base che compone Swing è un elegante cristallo veneziano lavorato "a balotòn" che dona a questa collezione una meravigliosa dinamicità e una stupefacente presenza scenica. Sostenuti da fini cavi di acciaio fissati alla sottile struttura a soffitto, questi elementi compongono figure delicatamente sinuose e ondeggianti sia in forma circolare che in forma libera.

The basic feature of Swing is an elegant piece of crafted Venetian crystal with the "a balotòn" technique, that gives the collection exceptional dynamism and a striking theatrical presence. Supported by slender steel cables attached to a thin structure on the ceiling, these parts form delicately sinuous and wavering figures, in circular or free-form configurations.

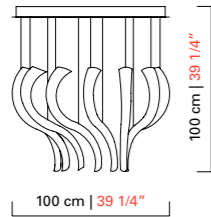
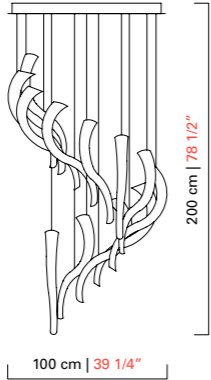
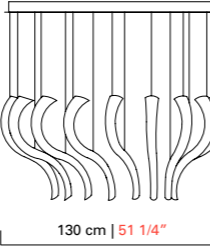
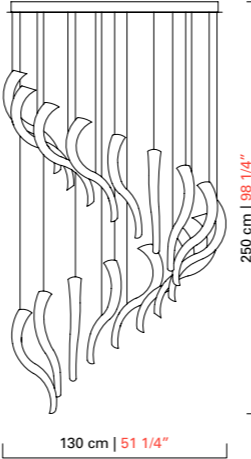

Modelli e misure <i>Models and sizes</i>	Swing 7323-00		Swing 7324-00		Swing 7325-00		Swing 7326-00	
								
Peso Weight	45 kg 99 lb		45 kg 99 lb		63 kg 138 lb		63 kg 138 lb	
Lampadine N. Tipo W max. Bulbs N. Type W max.	6+1 GU10 + Strip Led 20+34 20+34		6+1 GU10 + Strip Led 20+34 20+34		8+1 GU10 + Strip Led 20+52 20+52		8+1 GU10 + Strip Led 20+52 20+52	
Dimmerabile Dimmable	D		D		D		D	
Lampadine incluse Bulbs included	GU10 Led + Strip Led		GU10 Led + Strip Led		GU10 Led + Strip Led		GU10 Led + Strip Led	
Certificazioni Cerification Marks	EAC		EAC		EAC		EAC	

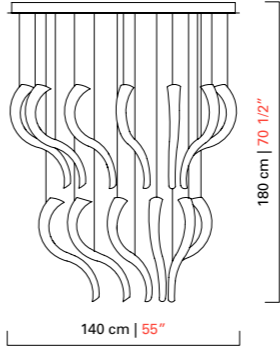
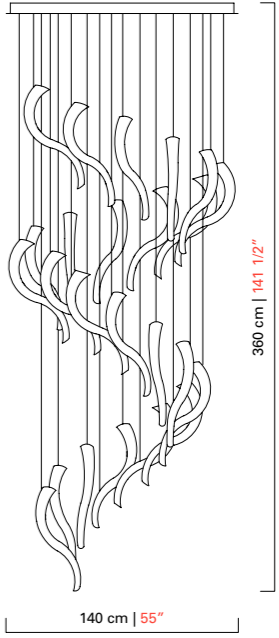
Modelli e misure <i>Models and sizes</i>	Swing 7327-00		Swing 7328-00	
				
Peso Weight	85 kg 187 lb		85 kg 187 lb	
Lampadine N. Tipo W max. Bulbs N. Type W max.	12+1 GU10 + Strip Led 20+42 20+42		12+1 GU10 + Strip Led 20+42 20+42	
Dimmerabile Dimmable	D		D	
Lampadine incluse Bulbs included	GU10 Led + Strip Led		GU10 Led + Strip Led	
Certificazioni Cerification Marks	EAC		EAC	

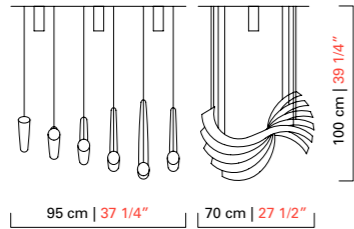
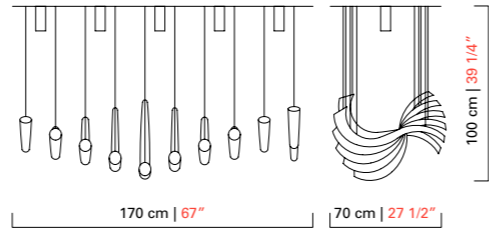
Modelli e misure <i>Models and sizes</i>	Swing 7329-00		Swing 7330-00	
				
Peso Weight	12 kg 26 lb		19 kg 42 lb	
Lampadine N. Tipo W max. Bulbs N. Type W max.	3 GU10 20 20		5 GU10 20 20	
Dimmerabile Dimmable	D		D	
Lampadine incluse Bulbs included	GU10 Led		GU10 Led	
Certificazioni Cerification Marks	EAC		EAC	

Colori disponibili <i>Available colours</i>					
CC Cristallo <i>Crystal</i>	IC Grigio <i>Grey</i>	EK Sabbia <i>Sand</i>	DK Oliva <i>Olive</i>	AK Blu Cadetto <i>Cadet Blue</i>	
					
LQ Bluastro <i>Bluastro</i>	FK Indaco <i>Indigo</i>	CK Pervinca <i>Periwinkle</i>	VI Viola <i>Violet</i>	OO Oro <i>Gold</i>	

Finiture <i>Finishings</i>	
CL Cromo Lucido <i>Polished Chrome</i>	

TRIM

Questa collezione attinge dall'archivio delle grandi installazioni realizzate da Barovier&Toso negli anni '60 e '70 attraverso la moltiplicazione e ripetizione di elementi modulari a canne o a poliedri, lisci o arricchiti dalle tradizionali lavorazioni muranesi. L'elemento esagonale realizzato con l'antica tecnica detta "ghiaccio" genera volumi sferici che perfettamente si integrano nell'architettura degli spazi diventandone quasi un'estensione. La posizione dei moduli può essere personalizzata al momento dell'installazione secondo il proprio estro: un ordine simmetrico e regolare oppure una forma disordinata.

The collection builds on the archive of large installations made by Barovier&Toso in the 1960s and 1970s, multiplying and repeating modular elements, simple or polyhedral, smooth or enhanced by traditional Murano workmanship. The hexagonal tube made with the age-old "ice" technique generates spherical volumes that fit perfectly into the architecture of spaces, almost becoming its extension. According to your own creativity, the position of the modules can be customized during installation into a symmetrical and conventional order or into a messy shape.



Modelli e misure Models and sizes

	Trim 7321-00	Trim 7322-00
Peso Weight	32 kg 70 lb	75 kg 165 lb
Lampadine Bulbs	N. Tipo W max. 7 Led 12 8	N. Tipo W max. 16 Led 12 8
Dimmerabile Dimmable	D	D
Lampadine incluse Bulbs included	Led	Led
Certificazioni Certification Marks		

Colori disponibili Available colours



CC
Cristallo
Crystal

Finiture Finishings



CL
Cromo Lucido
Polished Chrome



CN
Cromo Nero
Dark Chrome



OF
Ottone
Spazzolato Fine
Fine Brushed Brass

VALLONNÉ

Luca Nichetto

Vallonné è una collezione di lampade a sospensione in cristallo veneziano lavorato a mano e soffiato artigianalmente. Azione/reazione, espansione/contenimento: è in questo sistema di forze e di tensioni che nasce l'idea del progetto, dove la superficie dell'oggetto rivela una trama precisa di linee e di incisioni, facendo emergere una sequenza di rigonfiamenti dalle geometrie diverse. Nella collezione Vallonné, le lampade sono in cristallo trasparente e mostrano, all'interno, un'anima affusolata di vetro che nasconde la sorgente luminosa.

Vallonné is a collection of suspension lamps in Venetian Crystal, mouth blown and crafted by hand. Action/reaction, expansion/retraction: the idea of the design stems from this system of forces and tensions, where the surfaces of the object reveal a precise pattern of lines and incisions, bringing out a sequence of expansions through various geometric shapes. In the Vallonné collection, the lamps are in transparent crystal and contain a tapered core of glass that conceals the light source.



Modelli e misure
Models and sizes

Vallonné
7394-00

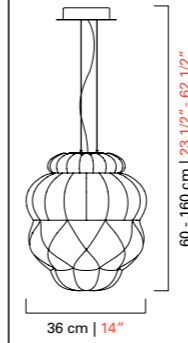

Vallonné
7398-00

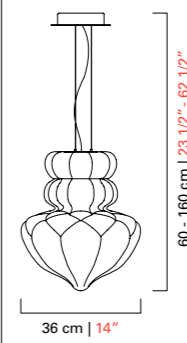

Peso
Weight

9 kg
20 lb

9 kg
20 lb

Lampadine N. Tipo W max.
Bulbs N. Type W max.

1 Led 10
10

1 Led 10
10

Dimmerabile
Dimmable

D

D

Lampadine incluse
Bulbs included

Strip Led

Strip Led

Certificazioni
Certification Marks



Colori disponibili
Available colours



CC
Cristallo
Crystal



FK
Indaco
Indigo



CK
Pervinca
Periwinkle



EK
Sabbia
Sand

Finiture
Finishings



CN
Cromo Nero
Dark Chrome



OZ
Bronzo Miele
Honey Bronze

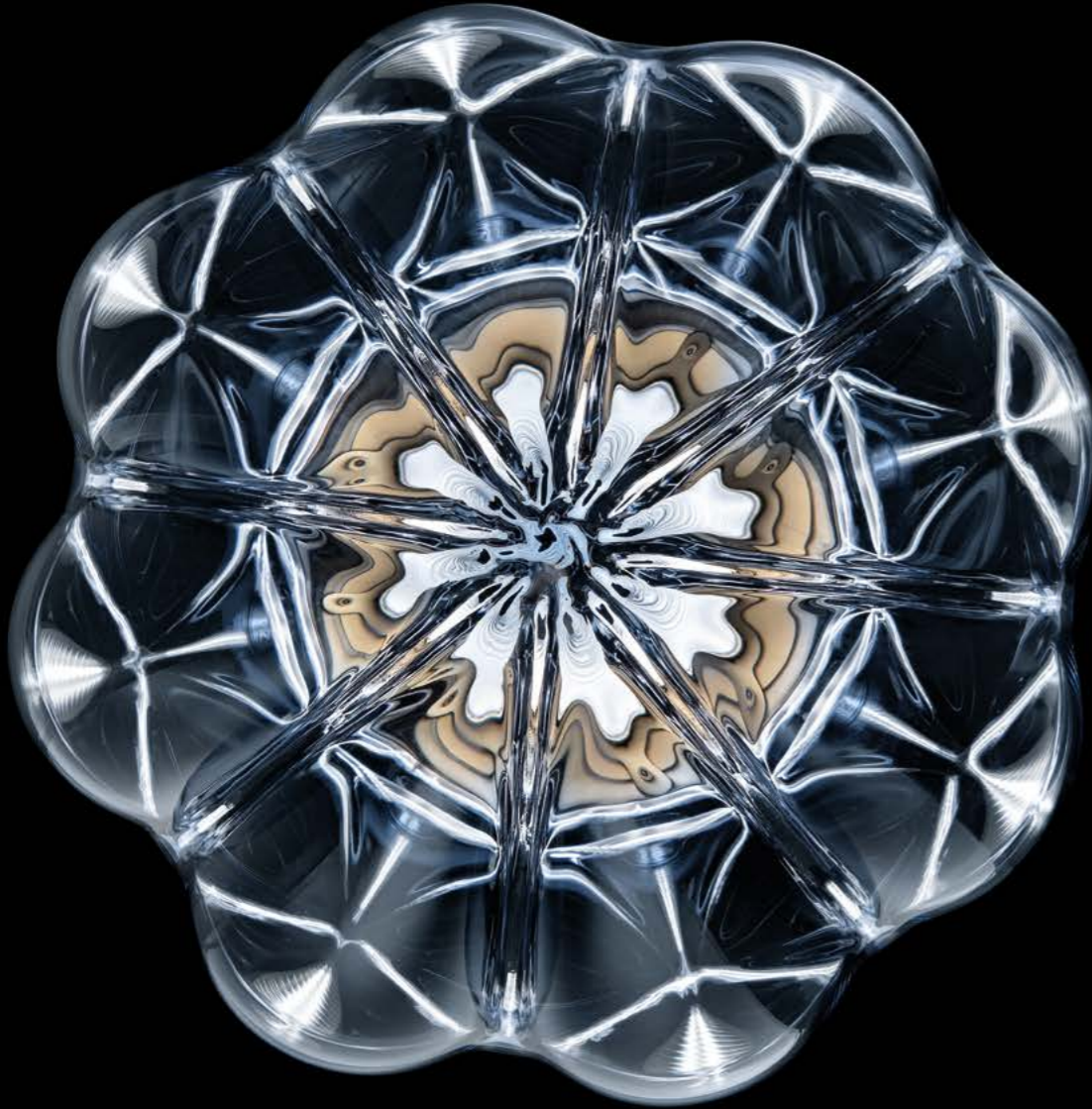

VALLONNÉ OPALE



Luca Nichetto

Vallonné Opale è una collezione di lampade a sospensione in cristallo veneziano lavorato a mano e soffiato artigianalmente. Azione/reazione, espansione/contenimento: è in questo sistema di forze e di tensioni che nasce l'idea del progetto, dove la superficie dell'oggetto rivela una trama precisa di linee e di incisioni, facendo emergere una sequenza di rigonfiamenti dalle geometrie diverse. Vallonné Opale, realizzata con la tecnica del vetro incamiciato, presenta esternamente un effetto opalino e lattiginoso che diffonde morbidamente la luce.

Vallonné Opale is a collection of suspension lamps in Venetian Crystal, mouth blown and crafted by hand. Action/reaction, expansion/retraction: the idea of the design stems from this system of forces and tensions, where the surfaces of the object reveal a precise pattern of lines and incisions, bringing out a sequence of expansions through various geometric shapes. Vallonné Opale is made with the jacketing technique, with an opaline, milky external effect that spreads light gently.

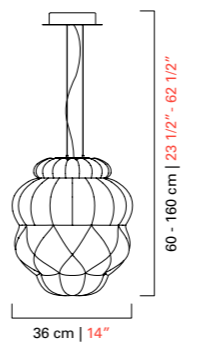
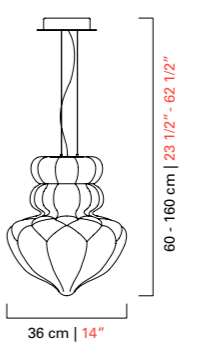

Modelli e misure Models and sizes

	Vallonné Opale 7395-00	Vallonné Opale 7399-00
		
Peso Weight	9 kg 20 lb	9 kg 20 lb
Lampadine N. Tipo W max. Bulbs N. Type W max.	1 E27 100 1 E26 100	1 E27 100 1 E26 100
Dimmerabile Dimmable	D	D
Lampadine incluse Bulbs included		
Certificazioni Certification Marks		

Colori disponibili Available colours



BB
Bianco
White

Finiture Finishings



CN
Cromo Nero
Dark Chrome



OZ
Bronzo Miele
Honey Bronze

WEBB

La luce si moltiplica e danza nello spazio, creando pattern e prospettive inaspettate, come costellazioni in movimento. Webb gioca con la prospettiva, legge lo spazio, e con grande libertà lo anima. A definire l'infinito spettro di possibilità compositive è proprio la sua modularità. Tutto ruota intorno al modulo base in cristallo veneziano, di forma esagonale, a punta di diamante. Il tutto è impreziosito dalla tecnica della rugiada capace di conferire al cristallo una texture irregolare, diffondendo la luce morbidamente nell'ambiente. Montate su leggere strutture metalliche di sostegno, sono tre le strisce di led che percorrono il retro dell'esagono in cristallo, andandone a sottolineare la forma convessa.

Light multiplies and dances through space, creating patterns and unexpected perspectives, like constellations in motion. Webb plays with perspective, interpreting space and bringing it to life with extraordinary freedom. At the heart of its infinite compositional possibilities is its modularity. Everything revolves around a Venetian crystal module, hexagonal with a diamond-like point. The Rugiada technique gives the crystal an irregular texture, allowing light to diffuse softly into the environment. Mounted on lightweight metal structures, three LED strips run along the back of each crystal hexagon, accentuating its convex shape.



Modelli e misure Models and sizes

	Webb 7550-00	Webb 7551-00	Webb 7552-00	Webb 7553-00
Peso Weight	80 kg 176 lb	24 kg 53 lb	40 kg 88 lb	40 kg 88 lb
Lampadine Bulbs	N. Tipo W max. 40 Led 3	N. Tipo W max. 12 Led 3	N. Tipo W max. 19 Led 3	N. Tipo W max. 19 Led 3
Dimmerabile Dimmable	D	D	D	D
Lampadine incluse Bulbs included	Led	Led	Led	Led
Certificazioni Certification Marks				

Colori disponibili Available colours



CR
Cristallo Rugiada
Crystal Rugiada

Finiture Finishings



CL
Cromo Lucido
Polished Chrome



CEILING

Si integrano e si combinano con l'architettura degli ambienti creando un dialogo tra superfici e luci, tra spazio bidimensionale e tridimensionale. Puntuali, oppure modulari, realizzano atmosfere inebrianti e sofisticate.

They interact and combine with the architecture of spaces, creating a dialogue between surfaces and lights, in two and three dimensions. Used individually or in compositions, they produce inebriating and sophisticated atmospheres.

AGAVE

García Cumini

Agave è una collezione ispirata alla pianta omonima, simbolo di eleganza e resilienza, reinterpretata in cristallo veneziano dai designer García Cumini. La sua iconica foglia allungata richiama la tradizione vetraria di Barovier&Toso ed è arricchita dalla tecnica della rugiada, che ne esalta la brillantezza e la texture tridimensionale. Un innovativo effetto sfumato, ottenuto con graniglia di vetro colorato, valorizza ulteriormente il design. Questa lavorazione diffonde la luce in modo dinamico, evocando i raggi solari filtrati tra le foglie dell'agave.

Agave is a collection inspired by the plant of the same name, a symbol of elegance and resilience, reinterpreted in Venetian crystal by designers García Cumini. Its iconic elongated leaf recalls Barovier&Toso's glassmaking tradition and is enriched by the dew technique, which enhances its brilliance and three-dimensional texture. An innovative shaded effect, obtained with coloured glass beads, further enhances the design. This workmanship diffuses light dynamically, evoking the sun's rays filtered through the leaves of the agave.



Modelli e misure Models and sizes

Agave

7577-00

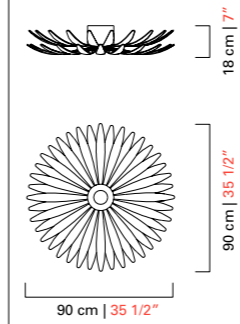

Peso

Weight

20 kg

44 lb

Lampadine

Bulbs

N. Tipo/Type 2+1 Strip Led + Led 8+8

W max. 8+8

Dimmerabile

Dimmable

D

Lampadine incluse

Bulbs included

Strip Led + Led

Certificazioni

Certification Marks

Colori disponibili Available colours



CR

Cristallo Rugiada
Crystal Rugiada



GQ

Cristallo Cognac
Rugiada
Crystal Cognac
Rugiada

Finiture

Finishings



CL

Cromo Lucido
Polished Chrome

ALUMINA

Alessandro Piva

Con un lato di 85 centimetri, è una plafoniera davvero importante, ma comunque leggera nell'aspetto. È composta da cinque elementi quadrangolari decorati a bolle sommerse e realizzati completamente a mano. A completare la composizione, ai cinque elementi in cristallo veneziano si aggiungono quattro griglie decorative in metallo a trama diversa. Grazie alla sua geometria, Alumina può essere utilizzata in molteplici unità affiancate, a formare una parete luminosa.

With a side measuring 33 1/2", it is a really considerable ceiling lamp, but still giving an appearance of lightness. It is made up by five quadrangular elements decorated with submerged bubbles all completely handcrafted. To complete the composition, four decorative and differently finished metal grilles are added to the five Venetian crystal elements. Thanks to its geometry, Alumina can be used in multiple modules side by side, to create a luminous wall.

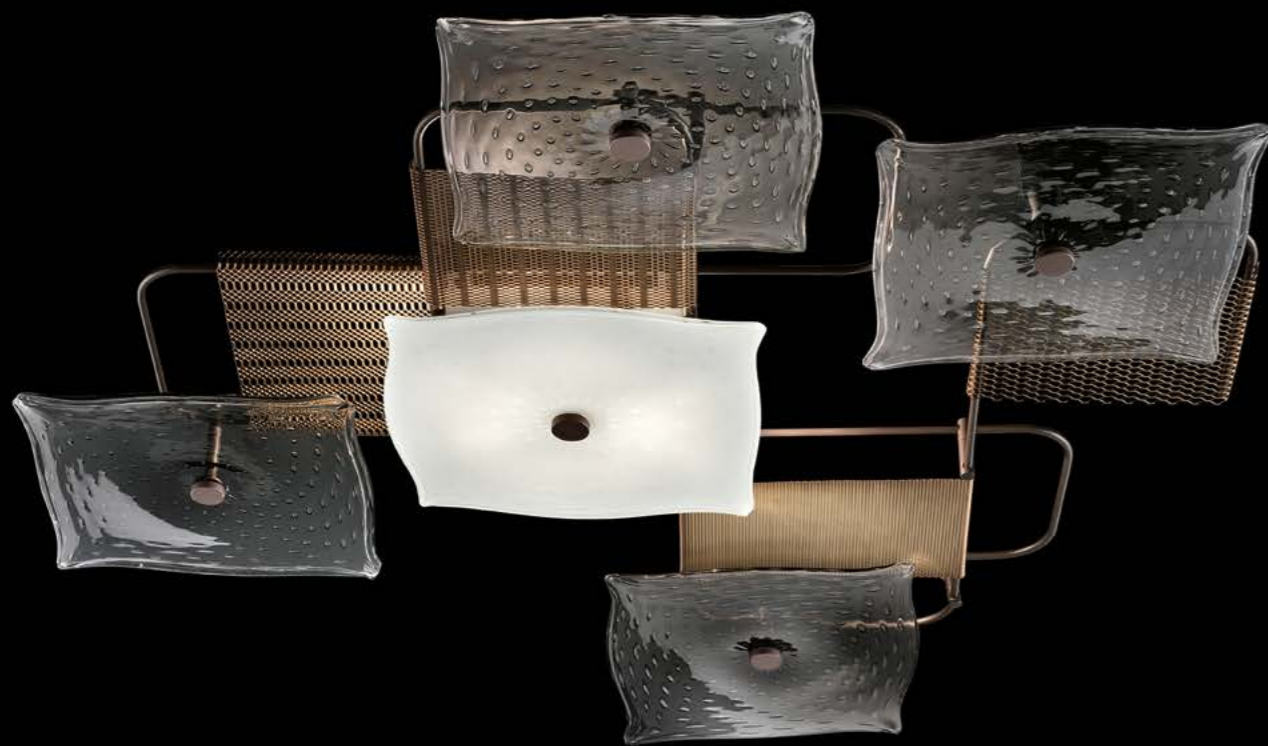

Modelli e misure Models and sizes

Alumina
7285-00

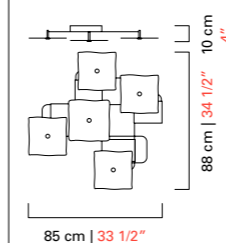

Peso Weight

8 kg
17 1/2 lb

Lampadine Bulbs

N.	Tipo	W max.	4	G9	4

Dimmerabile Dimmable

D

Lampadine incluse Bulbs included

G9 Led

Certificazioni Certification Marks



Colori disponibili Available colours



CC
Cristallo
Crystal



BW
Brown
Brown

Finiture Finishings



ZO
Bronzo Satinato
Satinized Bronze

ANVERSA

Questa lampada a soffitto prende a prestito il rostrato, elemento caratteristico di due collezioni di enorme successo, Amsterdam e Rotterdam, e lo abbina al diffusore bianco ed al cristallo veneziano in colori tenui dell'ogiva decorativa.

This ceiling lamp borrows the characteristic "rostrato" element from two highly successful collections, Amsterdam and Rotterdam, combining it with the white diffuser and the Venetian crystal in muted colors of the decorative nose cone.



Modelli e misure Models and sizes

	Anversa 5697-00	Anversa 5698-00
Peso Weight	4 kg 9 lb	7 kg 15 lb
Lampadine Bulbs	N. Tipo W max. 3 E14 60	N. Tipo W max. 3 E14 60
Dimmerabile Dimmable	D	D
Lampadine incluse Bulbs included		
Certificazioni Certification Marks		

Colori disponibili Available colours

Il colore si riferisce solo al finalino
The colour refers only to the final element



BC
Bianco/ Cristallo
White/ Crystal



DM
Bianco/ Cristallo/
Grigio
*White/ Crystal/
Grey*



DE
Bianco/ Cristallo/
Sabbia
*White/ Crystal/
Sand*



DD
Bianco/ Cristallo/
Oliva
*White/ Crystal/
Olive*



CZ
Bianco/ Cristallo/
Blu Cadetto
*White/ Crystal/
Cadet Blue*



LT
Bianco/ Cristallo/
Bluastro
*White/ Crystal/
Bluastro*



DH
Bianco/ Cristallo/
Indaco
*White/ Crystal/
Indigo*



DC
Bianco/ Cristallo/
Pervinca
*White/ Crystal/
Periwinkle*



BT
Bianco/ Cristallo/
Viola
*White/ Crystal/
Violet*



CS
Bianco/ Cristallo/
Oro
*White/ Crystal/
Gold*

Finiture Finishings



CL
Cromo Lucido
Polished Chrome

CLEPSYDRA

Vortici di clessidre muovono lo spazio con la luce, presenza danzante che attraversa ogni elemento in cristallo veneziano, rigato con l'antica tecnica del Rigadin. Sinuosamente definite, le clessidre si ripetono e si sovrappongono, creando lampade ricche e dense, ispirate ai disegni degli anni '60 recuperati dallo storico archivio Barovier&Toso.

Whirls of hourglasses move in space with light, a dancing presence that crosses each part in Venetian Crystal, lined with the age-old Rigadin technique. Sinuously shaped, the hourglasses repeat and overlap, creating dense, elegant lamps based on drawings from the 1960s contained in the historical archives of Barovier&Toso.



Modelli e misure Models and sizes

	Clepsydra 7476-00	Clepsydra 7477-00
Peso Weight	95 kg 209 lb	145 kg 319 lb
Lampadine Bulbs	N. Tipo W max. 12 E14 40 E12 40	N. Tipo W max. 16 E14 40 E12 40
Dimmerabile Dimmable	D	D
Lampadine incluse Bulbs included		
Certificazioni Certification Marks	ERAC	ERAC

Colori disponibili Available colours



CC
Cristallo
Crystal

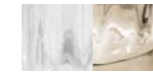

FE
Cristallo / Sabbia
Crystal / Sand

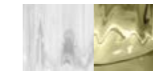

FD
Cristallo / Oliva
Crystal / Olive

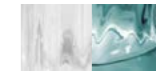

FF
Cristallo / Blu Cadetto
Crystal / Cadet Blue

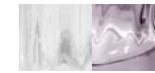

FP
Cristallo / Pervinca
Crystal / Periwinkle

Finiture Finishings



CL
Cromo Lucido
Polished Chrome



OG
Oro Galvanizzato
Galvanized Gold

EMPIRE

Fortemente tridimensionali, collaborano con l'architettura degli ambienti a definirne volumi e confini. La struttura delle lampade è completamente celata e dal soffitto piovono nuvole di tubi a sezione quadrata. Le composizioni disegnano piramidi asimmetriche rovesciate, ispirandosi alle geometrie rigorose ed energiche tipiche dell'Art Déco. Gli elementi si sovrappongono, si affiancano, con lunghezze diverse e con una ritmata alternanza di colori, nelle versioni policrome. La lavorazione a corteccia del cristallo veneziano crea delle deformazioni irregolari sulla superficie e particolari rifrazioni della luce, per un effetto d'insieme soffuso, costellato da scintillii puntuali.

Forcefully three-dimensional, these pieces interact with the architecture of spaces, defining volumes and boundaries. The structure of the lamps is completely concealed, while tubes with a square cross-section descend from the ceiling. The compositions form asymmetrical overturned pyramids, based on the rigorous and energetic geometric shapes of Art Deco. The parts are overlaid and juxtaposed, with different lengths and a rhythmical alternation of colours in the polychrome versions. The a corteccia workmanship of the Venetian Crystal creates irregular variations on the surface and particular refractions of the light, for an overall effect of soft brightness punctuated by sparkling highlights.



Modelli e misure Models and sizes	Empire 7466-00	Empire 7467-00	Empire 7468-00
Peso Weight	78 kg 171,5 lb	120 kg 264 lb	178 kg 391,5 lb
Lampadine Bulbs	N. Tipo W max. 9 E14 40 E12 40	N. Tipo W max. 16 E14 40 E12 40	N. Tipo W max. 24 E14 40 E12 40
Dimmerabile Dimmable	D	D	D
Lampadine incluse Bulbs included			
Certificazioni Cerification Marks	EAC	EAC	EAC

Colori disponibili Available colours



CC
Cristallo
Crystal



EE
Cristallo / Grigio /
Sabbia
Crystal / Grey /
Sand



ED
Cristallo / Grigio /
Oliva
Crystal / Grey /
Olive



EF
Cristallo / Grigio /
Blu Cadetto
Crystal / Grey /
Cadet Blue

Finiture Finishings



CL
Cromo Lucido
Polished Chrome







OG
Oro Galvanizzato
Galvanized Gold

EXCELSIOR

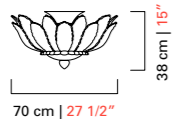
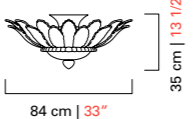
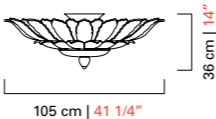
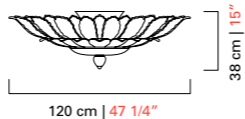

Oggetti che rimandano alla magnificenza dei grandi progetti di alberghi e navi da crociera realizzati da Barovier&Toso nella prima metà del '900. Plafoniere di grande eleganza, proposte in suggestive e particolari finiture.

Objects that recall the magnificence of the big hospitality and cruise projects that Barovier&Toso developed during the first half of the 20th century. Extremely elegant ceiling lamps proposed in a distinctive range of finishes.

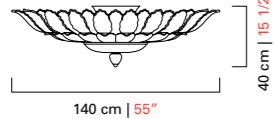

Modelli e misure <i>Models and sizes</i>	Excelsior 5363-00	Excelsior 5364-00	Excelsior 5426-00	Excelsior 5427-00
	 70 cm 27 1/2" 38 cm 15"	 84 cm 33" 35 cm 13 1/2"	 105 cm 41 1/4" 36 cm 14"	 120 cm 47 1/4" 38 cm 15"
Peso Weight	22 kg 48 lb	28 kg 62 lb	54 kg 119 lb	63 kg 139 lb
Lampadine N. Tipo W max. Bulbs N. Type W max.	6 E14 60 E12 60	6+3 E14 60+40 E12 60+40	8+3 E27+E14 60+40 E26+E12 60+40	10+4 E27+E14 60+40 E26+E12 60+40
Dimmerabile Dimmable	D	D	D	D
Lampadine incluse Bulbs included				
Certificazioni Certification Marks				

Colori disponibili
Available colours**CR**
Cristallo Rugiada
Crystal Rugiada**GR**
Champagne Rugiada
Champagne Rugiada**OR**
Oro Rugiada
*Gold Rugiada***Finiture**
Finishings**OG**
Oro Galvanizzato
Galvanized Gold

Modelli e misure <i>Models and sizes</i>	Excelsior 5428-00
	 140 cm 55" 40 cm 15 1/2"
Peso Weight	72 kg 158 lb
Lampadine N. Tipo W max. Bulbs N. Type W max.	15+3 E27+E14 60+40 E26+E12 60+40
Dimmerabile Dimmable	D
Lampadine incluse Bulbs included	
Certificazioni Certification Marks	

NEW FELCI

Per immergersi in una suggestiva atmosfera dallo stile déco, ammiccando al gusto glamour degli anni '20 e '30. Il fascino di una cascata di luce composta da brillanti e voluttuose foglie in cristallo veneziano delicatamente arricciate alle estremità.

For a plunge into an evocative Deco mood that takes its cue from the glamour of the 1920s and 1930s. The charm of a cascade of light composed of sparkling and voluptuous leaves of Venetian crystal, delicately curled at the extremities.



Modelli e misure Models and sizes

	New Felci 7244-00	New Felci 7245-00																		
Peso Weight	46 kg 101 lb	72 kg 158 lb																		
Lampadine Bulbs	<table border="1"> <thead> <tr> <th>N.</th> <th>Tipo</th> <th>W max.</th> </tr> </thead> <tbody> <tr> <td>8+1</td> <td>E14+E14</td> <td>60+40</td> </tr> <tr> <td></td> <td>E12+E12</td> <td>5+5</td> </tr> </tbody> </table>	N.	Tipo	W max.	8+1	E14+E14	60+40		E12+E12	5+5	<table border="1"> <thead> <tr> <th>N.</th> <th>Tipo</th> <th>W max.</th> </tr> </thead> <tbody> <tr> <td>12+1</td> <td>E14+E14</td> <td>60+40</td> </tr> <tr> <td></td> <td>E12+E12</td> <td>60+40</td> </tr> </tbody> </table>	N.	Tipo	W max.	12+1	E14+E14	60+40		E12+E12	60+40
N.	Tipo	W max.																		
8+1	E14+E14	60+40																		
	E12+E12	5+5																		
N.	Tipo	W max.																		
12+1	E14+E14	60+40																		
	E12+E12	60+40																		
Dimmerabile Dimmable	D	D																		
Lampadine incluse Bulbs included																				
Certificazioni Certification Marks																				

Colori disponibili Available colours



CC
Cristallo
Crystal

Finiture Finishings



CL
Cromo Lucido
Polished Chrome



OG
Oro Galvanizzato
Galvanized Gold







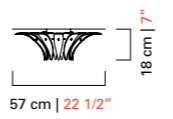
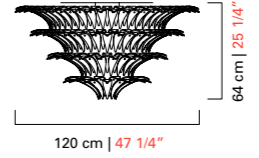
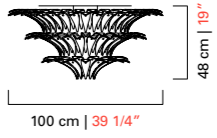
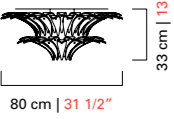

PALMETTE

Una collezione che si distingue per la preziosità delle lavorazioni, rigorosamente realizzate artigianalmente e frutto di una ricerca stilistica che attinge alla storia per darne una interpretazione in chiave contemporanea. Ventagli in foglie di cristallo, sovrapposti a formare due, tre e quattro livelli per una rilettura intrigante dello stile déco.

A collection that stands out for precious workmanship rigorously done by hand, result of stylistic research that draws on history, granting it a contemporary interpretation. Fans of crystal leaves, placed to form two, three and four levels, for an intriguing take on Art Deco.



Modelli e misure Models and sizes

	Palmette 7501-00	Palmette 7502-00	Palmette 7503-00	Palmette 7504-00
				
Peso Weight	10 kg 22 lb	105 kg 231 lb	55 kg 121 lb	27 kg 60 lb
Lampadine Bulbs	N. Tipo W max. 2 E14 60 E12 40	28 E27 60 E26 40	16 E27 60 E26 40	6 E27 60 E26 40
Dimmerabile Dimmable	D	D	D	D
Lampadine incluse Bulbs included				
Certificazioni Certification Marks	ERAC  	ERAC  	ERAC  	ERAC  

Colori disponibili Available colours



CC
Cristallo
Crystal

Finiture Finishings



CL
Cromo Lucido
Polished Chrome



OG
Oro Galvanizzato
Galvanized Gold





PIGALLE

Tradizione ed innovazione si fondono in questa collezione ispirata alla Belle Époque. Si caratterizza per eleganza e linee sinuose senza risultare eccessiva ed ostentata. Eloquente per raffinatezza e grazia alterna linee semplici, dettagli curvi e lavorazioni tradizionali.

Tradition and innovation blend in this collection inspired by the Belle Époque. It stands out for its elegant, sinuous lines, without ever seeming excessive or ostentatious. With its eloquent refinement and grace, it mixes simple lines, curved details and traditional workmanship.

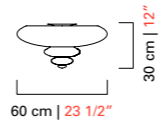

Modelli e misure Models and sizes

	Pigalle 5688-00	Pigalle 5690-00
		
Peso Weight	7 kg 15 lb	4 kg 9 lb
Lampadine Bulbs	N. Tipo W max. 3 E14 60 E12 60	N. Tipo W max. 3 E14 60 E12 60
Dimmerabile Dimmable	D	D
Lampadine incluse Bulbs included		
Certificazioni Certification Marks		

Colori disponibili Available colours



BC
Bianco/ Cristallo
White/ Crystal

Finiture Finishings



CL
Cromo Lucido
Polished Chrome



CN
Cromo Nero
Dark Chrome







OJ
Oro Spazzolato
Brushed Gold

PIUME

Riprese dai disegni degli anni '20 e '30 del nostro archivio storico, queste plafoniere sono un omaggio allo stile Déco. Con le loro ricche piume evocano ambientazioni lussuose e ricercate. Adatte ad ambienti estremamente decorati come anche, per contrasto, ad interni più minimali.

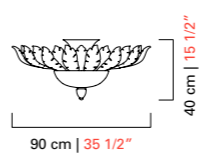
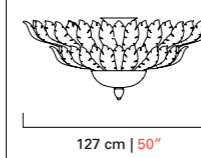
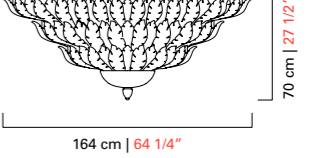
Resumed from drawings of the 20ies and 30ies from our historical archive, these ceiling lamps pay a tribute to the Déco era. With their rich feathers they evoke luxurious and refined settings. Perfect for extremely decorated ambiances as well as, playing with contrasts, for more minimal interior design projects.



Modelli e misure <i>Models and sizes</i>	Piume	Piume	Piume
	5399-00	5400-00	5401-00
			
Peso Weight	33 kg 73 lb	80 kg 176 lb	140 kg 308 lb
Lampadine Bulbs	N. Tipo W max. 8+3 E27+E14 60+40 E26+E12 60+40	N. Tipo W max. 14+3 E27+E14 60+40 E26+E12 60+40	N. Tipo W max. 30+3 E27+E14 60+40 E26+E12 60+40
Dimmerabile Dimmable	D	D	D
Lampadine incluse Bulbs included			
Certificazioni Certification Marks			

Colori disponibili *Available colours*



OB
Oro Beige
Beige Gold

Finiture *Finishings*



OG
Oro Galvanizzato
Galvanized Gold

PLISSÉ

Una collezione di plafoniere direttamente ispirata dalla tradizione. Gli elementi in cristallo veneziano sono realizzati grazie a una tecnica brevettata da Barovier&Toso, che consente di ottenere un effetto striato regolare che alterna il colore pieno a quello trasparente.

A collection of ceiling lamps directly inspired by the tradition. A technique patented by Barovier&Toso that allows to obtain a regular striped effect alternating matt and transparent colours on the Venetian crystal elements.



Modelli e misure Models and sizes

	Plissé 6700-00	Plissé 6701-00
Peso Weight	23 kg 51 lb	28 kg 62 lb
Lampadine N. Tipo W max. Bulbs N. Type W max.	8 E14 60 E12 25	9 E27 60 E26 25
Dimmerabile Dimmable	D	D
Lampadine incluse Bulbs included		
Certificazioni Certification Marks		

Colori disponibili Available colours



BB
Bianco
White

Finiture Finishings







VG
Verniciato Bianco
Painted White

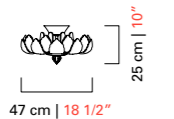
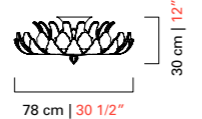
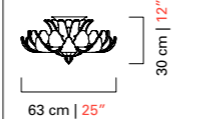
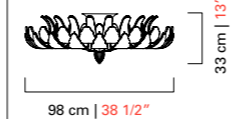

REX

Un grande fiore che fluttua nell'aria. Petali preziosi ed elaborati che grazie all'utilizzo della tecnica della "rugiada" sembrano dei merletti fatti a mano. Plafoniere spesso scelte all'inizio del '900 per grandi progetti di navi da crociera e alberghi di lusso sono ancora oggi dei pezzi unici capaci di donare un tocco retrò anche a progetti più contemporanei.

A large flower that floats in the air. Precious and elaborated petals that thanks to the "rugiada" technique seem handmade laces. These ceiling lamps were very common at the beginning of the 20th century in big cruises and luxury hotels projects but nowadays they are still unique pieces capable to give a retrò touch also to more contemporary projects.

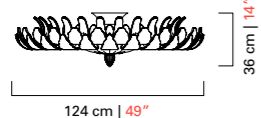

Modelli e misure <i>Models and sizes</i>	Rex 5387-00	Rex 5358-00	Rex 5357-00	Rex 5431-00
				
Peso Weight	10 kg 22 lb	29 kg 64 lb	18 kg 40 lb	54 kg 119 lb
Lampadine N. Tipo W max. Bulbs N. Type W max.	9 E14 60 E12 60	12 E14 60 E12 60	9+2 E14 60+40 E12 60+40	13 E14 60 E12 40
Dimmerabile Dimmable	D	D	D	D
Lampadine incluse Bulbs included				
Certificazioni Certification Marks				

Modelli e misure <i>Models and sizes</i>	Rex 5432-00
	
Peso Weight	72 kg 158 lb
Lampadine N. Tipo W max. Bulbs N. Type W max.	17 E14 60 E12 60
Dimmerabile Dimmable	D
Lampadine incluse Bulbs included	
Certificazioni Certification Marks	

Colori disponibili
Available colours

CR
 Cristallo Rugiada
Crystal Rugiada

GR
 Champagne Rugiada
Champagne Rugiada

OR
 Oro Rugiada
Gold Rugiada
Finiture
Finishings

OF
 Ottone
 Spazzolato Fine
Fine Brushed Brass



SPADE

Collezione di plafoniere ispirata ai fiori e alla natura che si contraddistingue per il suo delicato design a forma di corolla, realizzata con la tecnica della "rugiada" che dona un raffinato effetto ricamato. I petali si sovrappongono come a formare dei fiori schiusi, sospesi nell'aria.

A collection of ceiling lamps with an accent on flowers and nature, which stands out for its delicate design in the form of a corolla, made with the "rugiada" technique to create a refined embroidered look. Petals overlap to form the image of a blossoming flower, suspended in the air.

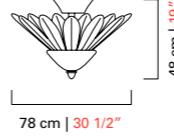
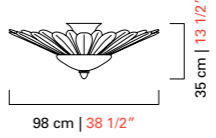

Modelli e misure Models and sizes

	Spade 6744-00	Spade 6745-00
		
Peso Weight	32 kg 70 lb	41 kg 90 lb
Lampadine Bulbs	N. Tipo W max. 8+2 E14 60+40 E12 60+40	N. Tipo W max. 8+3 E14 60+40 E12 60+40
Dimmerabile Dimmable	D	D
Lampadine incluse Bulbs included		
Certificazioni Certification Marks		

Colori disponibili Available colours



CR
Cristallo Rugiada
Crystal Rugiada

Finiture Finishings



CL
Cromo Lucido
Polished Chrome



OG
Oro Galvanizzato
Galvanized Gold



OF
Ottone
Spazzolato Fine
Fine Brushed Brass

TOPKAPI

Daniela Puppa

Topkapi è una famiglia di lampade a soffitto che si caratterizzano per il contrasto tra il grande diffusore dalle linee moderne in vetro bianco sabbato - che diffonde una luce morbida e soffusa - e i classici finalini in cristallo trasparente o dai colori vivaci, che brillano per effetto dell'irradiazione diretta.

Topkapi is a family of ceiling lamps characterized by the contrast between the modern lines of the diffuser in white sanded glass which sends out a soft, suffused light, and the classic end-elements in transparent or vividly coloured crystal that shine with the brightness of direct lighting.



Modelli e misure Models and sizes

	Topkapi 7092-00	Topkapi 7093-00	Topkapi 7094-00	Topkapi 7095-00
Peso Weight	8 kg 18 lb	10 kg 22 lb	7 kg 15 lb	9 kg 20 lb
Lampadine Bulbs	N. Tipo W max. 2 E14 60 E12 60	N. Tipo W max. 3 E14 60 E12 60	N. Tipo W max. 2 E14 60 E12 60	N. Tipo W max. 3 E14 60 E12 60
Dimmerabile Dimmable	D	D	D	D
Lampadine incluse Bulbs included				
Certificazioni Certification Marks				

Colori disponibili Available colours

Il colore si riferisce solo al finalino
The colour refers only to the final element

BC Bianco/ Cristallo White/ Crystal	DM Bianco/ Cristallo/ Grigio White/ Crystal/ Grey	DE Bianco/ Cristallo/ Sabbia White/ Crystal/ Sand	DD Bianco/ Cristallo/ Olive White/ Crystal/ Olive	CZ Bianco/ Cristallo/ Blu Cadetto White/ Crystal/ Cadet Blue
LT Bianco/ Cristallo/ Bluastro White/ Crystal/ Bluastro	DH Bianco/ Cristallo/ Indaco White/ Crystal/ Indigo	DC Bianco/ Cristallo/ Pervinca White/ Crystal/ Periwinkle	BT Bianco/ Cristallo/ Viola White/ Crystal/ Violet	CS Bianco/ Cristallo/ Oro White/ Crystal/ Gold

Finiture Finishings





VG
Verniciato Bianco
Painted White

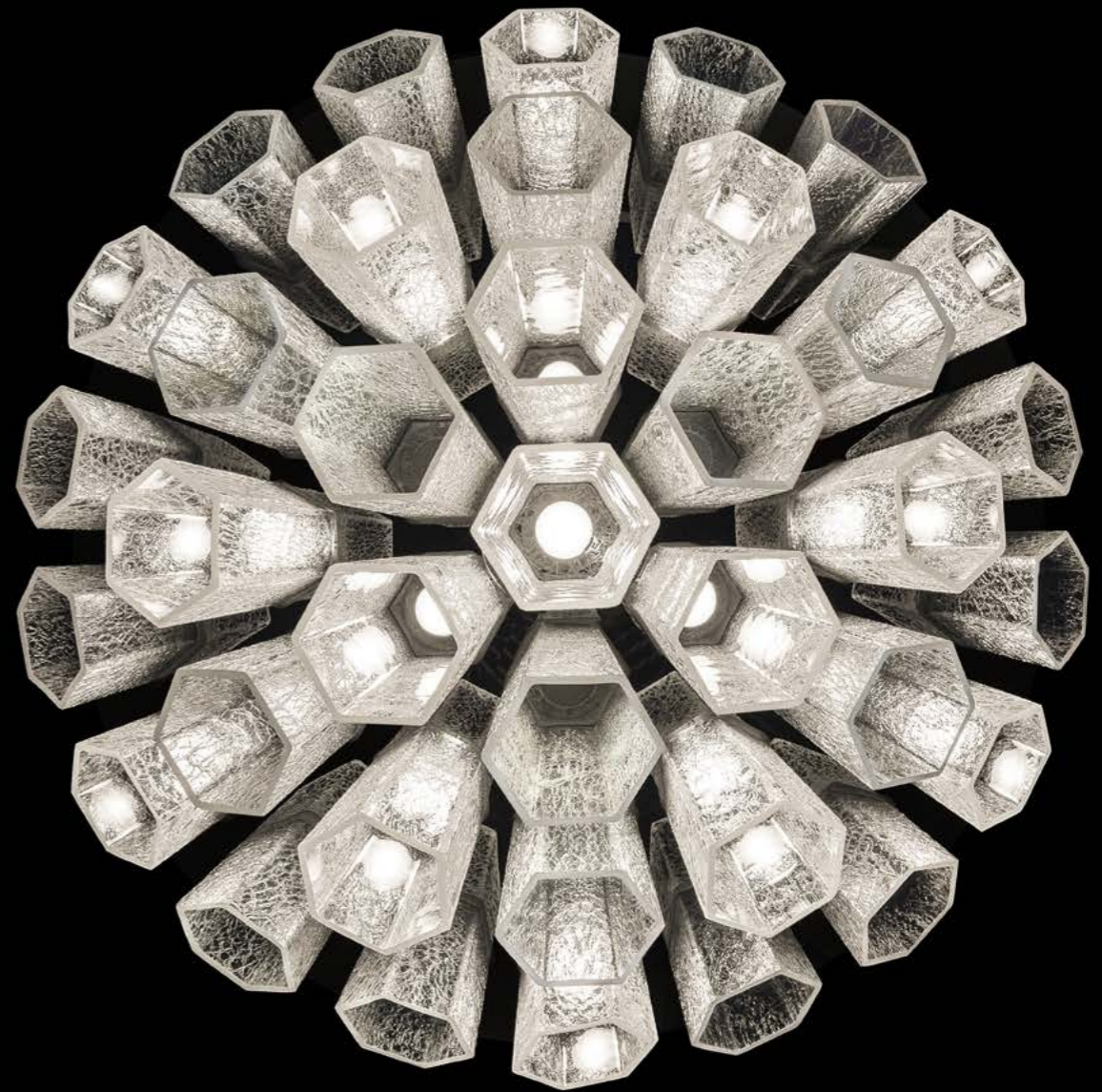

TRIM

Questa collezione attinge dall'archivio delle grandi installazioni realizzate da Barovier&Toso negli anni '60 e '70 attraverso la moltiplicazione e ripetizione di elementi modulari a canne o a poliedri, lisci o arricchiti dalle tradizionali lavorazioni muranesi. L'elemento esagonale realizzato con l'antica tecnica detta "ghiaccio" genera volumi sferici, per riflessione sul plafone specchiato, che perfettamente si integrano nell'architettura degli spazi diventandone quasi un'estensione. La posizione dei moduli può essere personalizzata al momento dell'installazione secondo il proprio estro: un ordine simmetrico e regolare oppure una forma disordinata.

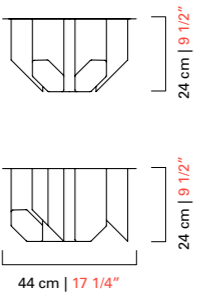
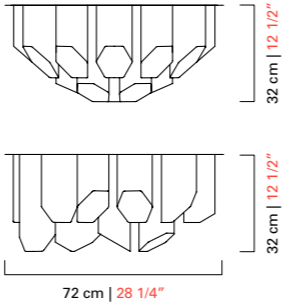
The collection builds on the archive of large installations made by Barovier&Toso in the 1960s and 1970s, multiplying and repeating modular parts, simple or polyhedral, smooth or enhanced by traditional Murano workmanship. The hexagonal tube made with the age-old "ice" technique generates spherical volumes, thanks to the reflection on the mirrored metal structure, that fit perfectly into the architecture of spaces, almost becoming its extension. According to your own creativity, the position of the modules can be customized during installation into a symmetrical and conventional order or into a messy shape.

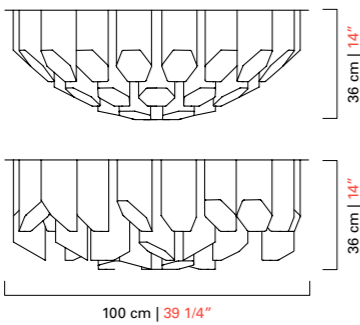
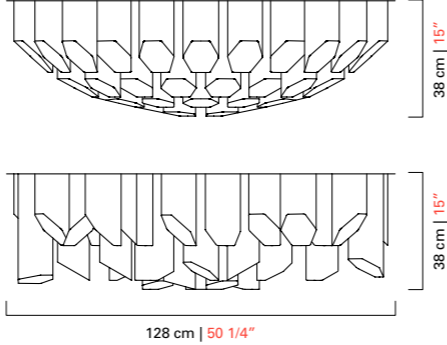

Modelli e misure <i>Models and sizes</i>	Trim	Trim
		7317-00
		
Peso Weight	18 kg 40 lb	45 kg 99 lb
Lampadine N. Tipo W max. Bulbs N. Type W max.	4 Led 12 8	10 Led 12 8
Dimmerabile Dimmable	D	D
Lampadine incluse Bulbs included	Led	Led
Certificazioni Cerification Marks		

Modelli e misure <i>Models and sizes</i>	Trim	Trim
		7319-00
		
Peso Weight	90 kg 198 lb	160 kg 352 lb
Lampadine N. Tipo W max. Bulbs N. Type W max.	16 Led 12 8	28 Led 12 8
Dimmerabile Dimmable	D	D
Lampadine incluse Bulbs included	Led	Led
Certificazioni Cerification Marks		

Colori disponibili
Available colours

CC
 Cristallo
Crystal
Finiture
Finishings

CL
 Cromo Lucido
Polished Chrome

CN
 Cromo Nero
Dark Chrome

OF
 Ottone
 Spazzolato Fine
Fine Brushed Brass

WEBB

La luce si moltiplica e danza nello spazio, creando pattern e prospettive inaspettate, come costellazioni in movimento. Webb gioca con la prospettiva, legge lo spazio, e con grande libertà lo anima. A definire l'infinito spettro di possibilità compositive è proprio la sua modularità. Tutto ruota intorno al modulo base in cristallo veneziano, di forma esagonale, a punta di diamante. Il tutto è impreziosito dalla tecnica della rugiada capace di conferire al cristallo una texture irregolare, diffondendo la luce morbidamente nell'ambiente. Montate su leggere strutture metalliche di sostegno, sono tre le strisce di led che percorrono il retro dell'esagono in cristallo, andandone a sottolineare la forma convessa.

Light multiplies and dances through space, creating patterns and unexpected perspectives, like constellations in motion. Webb plays with perspective, interpreting space and bringing it to life with extraordinary freedom. At the heart of its infinite compositional possibilities is its modularity. Everything revolves around a Venetian crystal module, hexagonal with a diamond-like point. The Rugiada technique gives the crystal an irregular texture, allowing light to diffuse softly into the environment. Mounted on lightweight metal structures, three LED strips run along the back of each crystal hexagon, accentuating its convex shape.

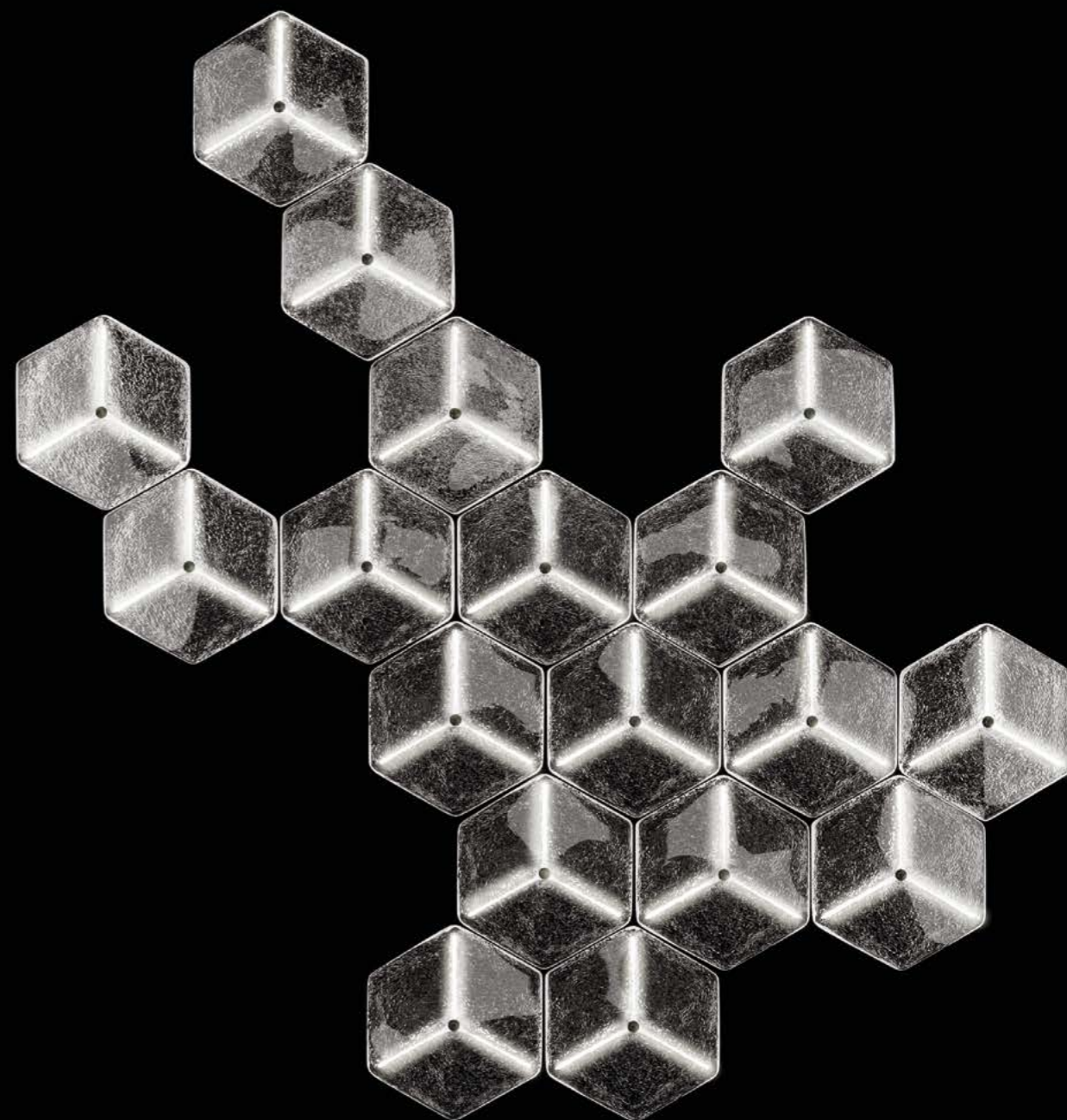
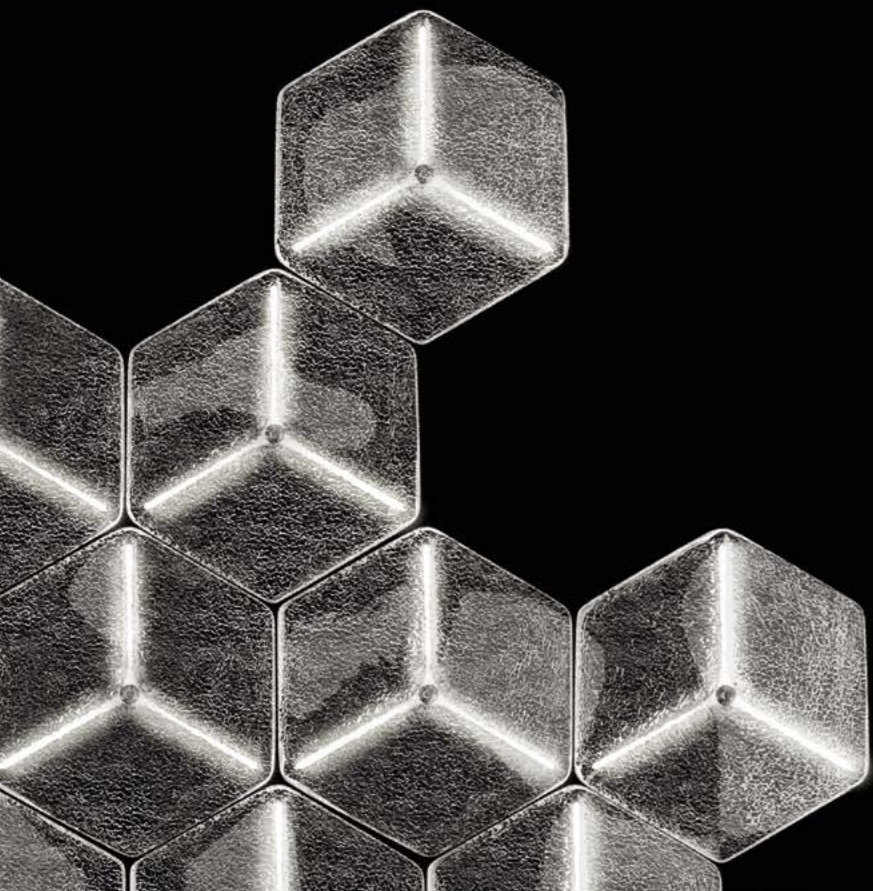

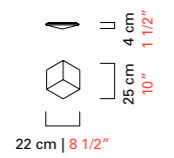
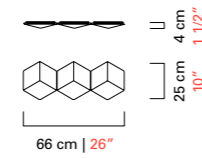
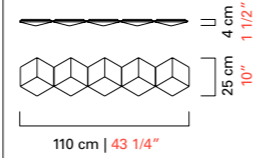
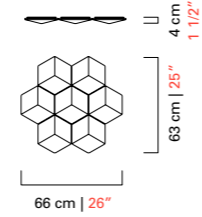
Modelli e misure <i>Models and sizes</i>	Webb 7560-00			Webb 7561-00			Webb 7562-00			Webb 7563-00		
												
Peso Weight	2 kg 4 lb			8 kg 18 lb			12 kg 26 lb			17 kg 37 lb		
Lampadine N. Tipo W max. Bulbs N. Type W max.	1	Led	3	3	Led	3	5	Led	3	7	Led	3
Dimmerabile Dimmable	D			D			D			D		
Lampadine incluse Bulbs included	Led			Led			Led			Led		
Certificazioni Certification Marks												

Colori disponibili
Available colours**CR**
Cristallo Rugiada
*Crystal Rugiada***Finiture**
Finishings**CL**
Cromo Lucido
Polished Chrome

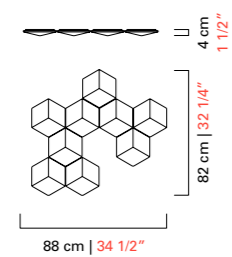
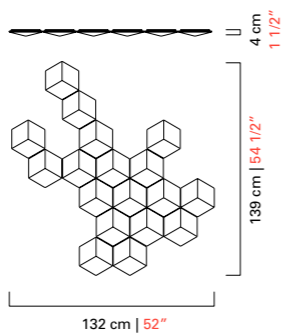
Modelli e misure <i>Models and sizes</i>	Webb 7564-00			Webb 7565-00		
						
Peso Weight	21 kg 46 lb			40 kg 88 lb		
Lampadine N. Tipo W max. Bulbs N. Type W max.	9	Strip Led	3	18	Led	3
Dimmerabile Dimmable	D			D		
Lampadine incluse Bulbs included	Led			Led		
Certificazioni Certification Marks						

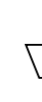

WALL

Punteggiano le pareti, come opere d'arte che impreziosiscono e vestono di personalità gli spazi da vivere e condividere. Dal gusto più classico a quello più semplice e moderno, ogni modello riesce ad enfatizzare la preziosità del Cristallo Veneziano e l'artigianalità delle sue lavorazioni.

They punctuate walls like works of art that enhance and bring personality to spaces for living and sharing. From the most classical taste to simple, modern styling, each model underscores the precious value of Venetian crystal, and the skill that goes into its making.

4604

Completano la collezione di lampadari in stile veneziano due lampade da parete in dimensioni diverse, riprendendo gli stessi elementi caratteristici quali foglie, fiori e pinnacoli.

The collection of Venetian style chandeliers is completed by two wall lamps in different sizes, taking up the same characteristic elements such as leaves, flowers and pinnacles.



Modelli e misure Models and sizes

	4604 4604-02	4604 4604-05
Peso Weight	7 kg 15 lb	13 kg 29 lb
Lampadine Bulbs	N. Tipo W max. 2 E14 60 E12 60	N. Tipo W max. 5 E14 60 E12 60
Dimmerabile Dimmable	D	D
Lampadine incluse Bulbs included		
Certificazioni Certification Marks		

Colori disponibili Available colours



CC
Cristallo
Crystal



CU
Cristallo/
Decoro Bluastro
Crystal/ Bluastro
Decoration



DO
Cristallo/
Decoro Oro
Crystal/ Gold
Decoration



***OO**
Oro
Gold
*Solo OG
Only OG



PC
Policromo
Polychrome

Finiture Finishings



CL
Cromo Lucido
Polished Chrome



***OG**
Oro Galvanizzato
Galvanized Gold
*Solo OO
Only OO

4607

Questa applique in cristallo veneziano è un eccellente esempio della raffinata lavorazione artigianale. Una moltitudine di decorazioni, dettagli preziosissimi, a completamento dei meravigliosi e fastosi lampadari della collezione.

This Venetian crystal wall lamp is an excellent example of refined craftsmanship. A multitude of decorations, precious details that complete the wonderful and sumptuous collection of chandeliers.



Modelli e misure Models and sizes

4607

4607-02

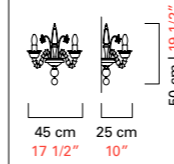

Peso

Weight

7 kg
15 lb

Lampadine

Bulbs

N.	Tipo	W max.
2	E14	60
	E12	60

Dimmerabile

Dimmable

D

Lampadine incluse

Bulbs included

Certificazioni

Certification Marks



Colori disponibili Available colours



CC

Cristallo
Crystal



CU

Cristallo/
Decoro Bluastro
Crystal/ Bluastro
Decoration



DO

Cristallo/
Decoro Oro
Crystal/ Gold
Decoration



***OO**

Oro
Gold
*Solo OG
Only OG



PC

Policromo
Polychrome

Finiture

Finishings



CL

Cromo Lucido
Polished Chrome



***OG**

Oro Galvanizzato
Galvanized Gold
*Solo OO
Only OO

ADONIS

Marcel Wanders

Adonis è una applique creata da Marcel Wanders, ispirata alla tradizione floreale olandese e contaminata da quella vetraria muranese che, da sempre, usa i fiori come elemento distintivo. Leggiadre farfalle e boccioli di tulipano adornano questa lampada a muro.

Adonis is a wall sconce created by Marcel Wanders, inspired by the Dutch floral tradition and fused with Murano glassmaking, which has always featured flowers as a distinctive feature. Graceful butterflies and tulip buds adorn this wall lamp.



Modelli e misure Models and sizes

Adonis
7360-01

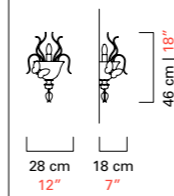

Peso Weight

7 kg
15 lb

Lampadine Bulbs

N.	Tipo	W max.		
1	E14	60		
	E12	60		

Dimmerabile Dimmable

D

Lampadine incluse Bulbs included

Certificazioni Certification Marks



Colori disponibili Available colours



CC
Cristallo
Crystal



AU
Cristallo/Verde
Antalia/ Cedro
Liquido
Crystal/ Antalia
Green/ Liquid Citron



LA
Cristallo/ Buaastro/
Acquamare
Crystal/ Buaastro/
Aquamarine



LN
Cristallo/ Caramello/
Cognac
Crystal/ Caramel/
Cognac



EU
Bianco/ Rubino/
Rosè
White/ Ruby/ Light
Pink

Finiture Finishings



CL
Cromo Lucido
Polished Chrome



***OG**
Oro Galvanizzato
Galvanized Gold
*Solo CC e LN
Only CC and LN

AGADIR

Dall'archivio storico pluricentenario di Barovier&Toso una lampada a muro in cristallo veneziano in grado di creare atmosfere incredibilmente rarefatte grazie alla luce soffusa che solo l'elaborata decorazione permette di avere. Minuziose lavorazioni di sapienti mani trasformano il vetro in luce.

From the centuries-old historical archive of Barovier&Toso, a wall sconce in Venetian crystal capable of creating incredibly rarefied atmospheres thanks to the soft radiance that can only be produced by elaborate decoration. Painstaking handwork transforms glass into light.



Modelli e misure Models and sizes

Agadir
5384-02

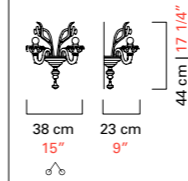

Peso Weight

3 kg
7 lb

Lampadine Bulbs

N.	Tipo	W max.
2	E14	60
	E12	60

Dimmerabile Dimmable

D

Lampadine incluse Bulbs included

Certificazioni Certification Marks



Colori disponibili Available colours



CC
Cristallo
Crystal



CU
Cristallo/
Decoro Bluastro
Crystal/ Bluastro
Decoration



DO
Cristallo/
Decoro Oro
Crystal/ Gold
Decoration



***OO**
Oro
Gold
*Solo OO
Only OO

Finiture Finishings



CL
Cromo Lucido
Polished Chrome



***OG**
Oro Galvanizzato
Galvanized Gold
*Solo OO
Only OO

AGAVE

García Cumini

Agave è una collezione ispirata alla pianta omonima, simbolo di eleganza e resilienza, reinterpretata in cristallo veneziano dai designer García Cumini. La sua iconica foglia allungata richiama la tradizione vetraria di Barovier&Toso ed è arricchita dalla tecnica della rugiada, che ne esalta la brillantezza e la texture tridimensionale. Un innovativo effetto sfumato, ottenuto con graniglia di vetro colorato, valorizza ulteriormente il design. Questa lavorazione diffonde la luce in modo dinamico, evocando i raggi solari filtrati tra le foglie dell'agave.

Agave is a collection inspired by the plant of the same name, a symbol of elegance and resilience, reinterpreted in Venetian crystal by designers García Cumini. Its iconic elongated leaf recalls Barovier&Toso's glassmaking tradition and is enriched by the dew technique, which enhances its brilliance and three-dimensional texture. An innovative shaded effect, obtained with coloured glass beads, further enhances the design. This workmanship diffuses light dynamically, evoking the sun's rays filtered through the leaves of the agave.



Modelli e misure Models and sizes

	Agave 7578-00	Agave 7579-00
Peso Weight	7 kg 15 lb	20 kg 44 lb
Lampadine Bulbs	N. Tipo/Type W max. 2 G9 7 G9 7	2+1 Strip Led + Led 8+8 8+8
Dimmerabile Dimmable	D	D
Lampadine incluse Bulbs included	G9	Strip Led + Led
Certificazioni Certification Marks		

Colori disponibili Available colours



CR
Cristallo Rugiada
Crystal Rugiada



GQ
Cristallo Cognac
Rugiada
*Crystal Cognac
Rugiada*

Finiture Finishings



CL
Cromo Lucido
Polished Chrome

ALEXANDRIA

Delicata, moderna, dalle linee pulite, la lampada da parete di questa collezione ha due luci ed i paralumi in tessuto plissettato.

Delicate, modern, with clean lines, the wall lamp of this collection has two lights and pleated fabric shades.



Modelli e misure Models and sizes

Alexandria
5597-02

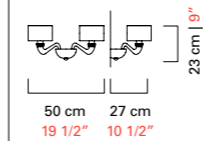

Peso Weight

4 kg
9 lb

Lampadine Bulbs

N.	Tipo	W max.
2	E14	60
	E12	60

Dimmerabile Dimmable

D

Lampadine incluse Bulbs included

Certificazioni Certification Marks



Colori disponibili Available colours



CC
Cristallo
Crystal



IC
Grigio
Grey



EK
Sabbia
Sand



DK
Oliva
Olive



AK
Blu Cadetto
Cadet Blue



LQ
Bluastro
Bluastro



FK
Indaco
Indigo



CK
Pervinca
Periwinkle



VI
Viola
Violet



***OO**
Oro
Gold
*Solo OO
Only OO

Finiture Finishings



CN
Cromo Nero
Dark Chrome



***OG**
Oro Galvanizzato
Galvanized Gold
*Solo OO
Only OO

Paralumi Shades

Nastro Pongè
Pongee Ribbon



16 cm | 6 1/4"



BB
Bianco
White



NN
Nero
Black

ALUMINA

Alessandro Piva

Quando si parla di lampade da parete, si pensa sempre a elementi di dimensioni contenute, ma non è decisamente il caso di Alumina: con un lato di 85 centimetri, è una lampada davvero importante, ma comunque leggera nell'aspetto. È composta da cinque elementi quadrangolari decorati a bolle sommerse e realizzati completamente a mano. A completare la composizione, ai cinque elementi in cristallo veneziano si aggiungono quattro griglie decorative in metallo a trama diversa. Grazie alla sua geometria, Alumina può essere utilizzata in molteplici unità affiancate, a formare una parete luminosa.

When one speaks of a wall light, we always think of something reasonable small, but this is definitively not the case with Alumina: with a side measuring 33 1/2", it is a really considerable lamp, but still giving an appearance of lightness. It is made up by five quadrangular elements decorated with submerged bubbles all completely handcrafted. To complete the composition, four decorative and differently finished metal grilles are added to the five Venetian crystal elements. Thanks to its geometry, Alumina can be used in multiple modules side by side, to create a luminous wall.



Modelli e misure Models and sizes

Alumina
7284-00

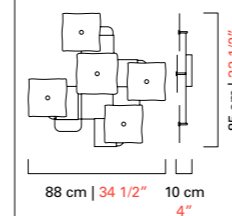

Peso

Weight

8 kg
17 1/2 lb

Lampadine

Bulbs

N.	Tipo	W max.
4	G9	4
		4

Dimmerabile

Dimmable

D

Lampadine incluse

Bulbs included

G9 Led

Certificazioni

Certification Marks



Colori disponibili

Available colours



CC
Cristallo
Crystal



BW
Brown
Brown

Finiture

Finishings



ZO
Bronzo Satinato
Satinized Bronze

AMSTERDAM

Applique che si caratterizza per il rostrato di cristallo, come il lampadario omonimo di cui è naturale complemento. Eleganza pragmatica, impreziosita da un tocco unico della tradizione vetraria di Venezia.

Wall sconce that is characterized by the crystal "rostrato," like the homonymous chandelier of which it is natural complement. Pragmatic elegance enriched by the unique touch of the Venetian glass-blowing tradition.

Domo Amsterdam design Franco Raggi

Il tradizionale fondino dove si inseriscono i bracci è sostituito da una struttura metallica dal disegno lineare.





A metal structure with a minimal design takes the place of the traditional glass chassis from where the arms depart.

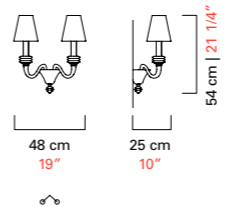
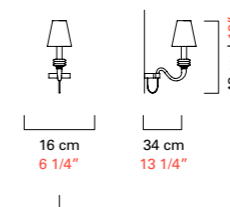
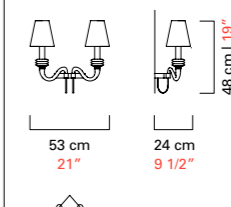

Amsterdam 5562/02

Domo Amsterdam 7114/02

Modelli e misure Models and sizes

	Amsterdam 5562-02	Domo Amsterdam 7114-01	Domo Amsterdam 7114-02
			
Peso Weight	4 kg 9 lb	2,5 kg 6 lb	4 kg 9 lb
Lampadine Bulbs	N. Tipo W max. 2 E14 60	N. Tipo W max. 1 E14 60	N. Tipo W max. 2 E14 60
Dimmerabile Dimmable	D	D	D
Lampadine incluse Bulbs included			
Certificazioni Certification Marks			

Colori disponibili Available colours

*Per Amsterdam la finitura abbinata al colore OO è sempre OG. Per Domo Amsterdam la finitura abbinata al colore OO può essere CL, CN o OF.
For Amsterdam the finishing matching colour OO is always OG.
For Domo Amsterdam the finishings matching colour OO can be CL, CN or OF.



CC
Cristallo
Crystal



IC
Grigio
Grey



EK
Sabbia
Sand



DK
Oliva
Olive



AK
Blu Cadetto
Cadet Blue



LQ
Bluastro
Bluastro



FK
Indaco
Indigo

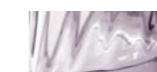

CK
Pervinca
Periwinkle



VI
Viola
Violet



***OO**
Oro
Gold

Finiture Finishings



CL
Cromo Lucido
Polished Chrome



***OG**
Oro Galvanizzato
Galvanized Gold
*Solo OO Amsterdam
Only OO Amsterdam



***CN**
Cromo Nero
Dark Chrome
*Solo Domo Amsterdam
Only Domo Amsterdam



***OF**
Ottone
Spazzolato Fine
Fine Brushed Brass
*Solo Domo Amsterdam
Only Domo Amsterdam

Paralumi Shades

Esterno: Cotone
External: Cotton

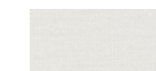
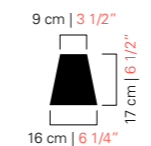

BB
Bianco
White



NN
Nero
Black



NO
Nero Interno Oro
Black Inner Gold

ANGEL

AI Design

Un ventaglio di piume che sembra fluttuare nello spazio come un'ala vaporosa che si dispiega leggera.

A feather fan that, seems to float in space like a vaporous wing that lightly unfolds itself.



Modelli e misure Models and sizes

Angel

7247-00

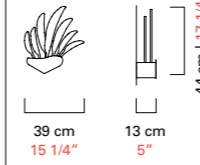

Peso

Weight

7 kg
15 lb

Lampadine

Bulbs

N.	Tipo	W max.	N.	Type	W max.
7	Led		1		
			1		

Dimmerabile

Dimmable

Lampadine incluse

Bulbs included

Led

Certificazioni

Certification Marks

ERAC

Colori disponibili

Available colours



CC

Cristallo
Crystal

Finiture

Finishings



VM

Verniciato Mirra
Painted Myrrh

ANVERSA

Questa applique prende a prestito il rostrato, elemento caratteristico di due collezioni di enorme successo, Amsterdam e Rotterdam, e lo abbina al diffusore bianco ed al cristallo veneziano in colori tenui dell'ogiva decorativa.

This wall sconce borrows the characteristic "rostrato" element from two highly successful collections, Amsterdam and Rotterdam, combining it with the white diffuser and the Venetian crystal in muted colors of the decorative nose cone.



Modelli e misure Models and sizes

Anversa
5699-00

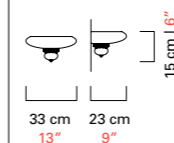

Peso Weight	4 kg 20 lb
Lampadine Bulbs	N. Tipo W max. 3 G9 25
Dimmerabile Dimmable	D
Lampadine incluse Bulbs included	G9 Led
Certificazioni Certification Marks	

Colori disponibili Available colours

Il colore si riferisce solo al finalino
The colour refers only to the final element



BC
Bianco/ Cristallo
White/ Crystal



DM
Bianco/ Cristallo/
Grigio
*White/ Crystal/
Grey*



DE
Bianco/ Cristallo/
Sabbia
*White/ Crystal/
Sand*



DD
Bianco/ Cristallo/
Oliva
*White/ Crystal/
Olive*



CZ
Bianco/ Cristallo/
Blu Cadetto
*White/ Crystal/
Cadet Blue*



LT
Bianco/ Cristallo/
Bluastro
*White/ Crystal/
Bluastro*



DH
Bianco/ Cristallo/
Indaco
*White/ Crystal/
Indigo*



DC
Bianco/ Cristallo/
Pervinca
*White/ Crystal/
Periwinkle*



BT
Bianco/ Cristallo/
Viola
*White/ Crystal/
Violet*



CS
Bianco/ Cristallo/
Oro
*White/ Crystal/
Gold*

Finiture Finishings



CL
Cromo Lucido
Polished Chrome

BABYLON

L'applique a due luci completa la collezione Babylon. Linee pulite e paralumi plissettati in tessuto, consentono di inserire questo prodotto in ogni ambientazione.

The two lights wall lamp completes the Babylon chandelier collection. Clean lines and pleated fabric lampshades allow to insert this product in any interior design project.



Modelli e misure Models and sizes

Babylon
5599-02

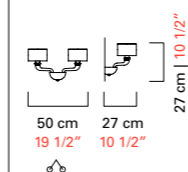

Peso Weight	4 kg 9 lb
Lampadine Bulbs	N. Tipo W max. 2 E14 60 N. Type W max. 2 E12 60
Dimmerabile Dimmable	D
Lampadine incluse Bulbs included	
Certificazioni Certification Marks	

Colori disponibili Available colours



CC
Cristallo
Crystal



IC
Grigio
Grey



EK
Sabbia
Sand



DK
Oliva
Olive



AK
Blu Cadetto
Cadet Blue



LQ
Bluastro
Bluastro



FK
Indaco
Indigo



CK
Pervinca
Periwinkle



VI
Viola
Violet



***OO**
Oro
Gold
*Solo OG
Only OG

Finiture Finishings



CN
Cromo Nero
Dark Chrome



***OG**
Oro Galvanizzato
Galvanized Gold
*Solo OO
Only OO

Paralumi Shades

Nastro Pongè
Pongee Ribbon

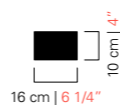

BB
Bianco
White



NN
Nero
Black

BAIKAL

Un'applique a due luci di ispirazione barocca. Ricca di dettagli preziosi come pendagli, pastorali e coppette che conferiscono maestosità e regalità rendendo l'oggetto assoluto protagonista dello spazio.

A two light wall sconce with a Baroque accent. Rich in precious details like pendants, pastorals and bobeches that add regal majesty, making the object the absolute protagonist of the space.



Modelli e misure Models and sizes

Baikal
5560-02

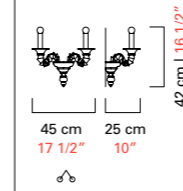

Peso
Weight

5 kg
11 lb

Lampadine N. Tipo W max.
Bulbs N. Type W max.

2 E14 60
E12 60

Dimmerabile
Dimmable

D

Lampadine incluse
Bulbs included

Certificazioni
Certification Marks



Colori disponibili Available colours



CC
Cristallo
Crystal



BB
Bianco
White



IC
Grigio
Grey



EK
Sabbia
Sand



DK
Oliva
Olive



LQ
Bluastro
Bluastro



FK
Indaco
Indigo



CK
Perivincia
Periwinkle



***OO**
Oro
Gold
*Solo OO
Only OO



NN
Nero
Black

Finiture Finishings



CL
Cromo Lucido
Polished Chrome



***OG**
Oro Galvanizzato
Galvanized Gold
*Solo OO
Only OO

BISSA BOBA

Angelo Barovier

In questa collezione l'applicque è a 3 luci. I bracci sembrano serpenti incantati che si ergono e allontanano sinuosamente dal centro.

In this collection the wall lamp has three lights. Its arms look like an enchanted snake, rising and sinuously moving away from the center.



Modelli e misure Models and sizes

Bissa Boba
6753-03

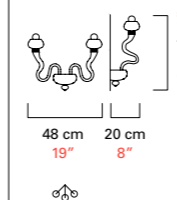

Peso Weight	3 kg 7 lb
Lampadine Bulbs	N. Tipo W max. 3 E14 60 N. Type W max. 3 E12 60
Dimmerabile Dimmable	D
Lampadine incluse Bulbs included	
Certificazioni Certification Marks	

Colori disponibili Available colours



CC
Cristallo
Crystal



IC
Grigio
Grey



EK
Sabbia
Sand



DK
Oliva
Olive



AK
Blu Cadetto
Cadet Blue



LQ
Bluastro
Bluastro



FK
Indaco
Indigo



CK
Pervinca
Periwinkle



VI
Viola
Violet



***OO**
Oro
Gold
*Solo OG
Only OG

Finiture Finishings



CL
Cromo Lucido
Polished Chrome



***OG**
Oro Galvanizzato
Galvanized Gold
*Solo OO
Only OO

CLEPSYDRA

Realizzate con l'antica tecnica del Rigadin, le clessidre sono rigate da sottili costolature, che vivacizzano la rifrazione della luce. Rivisitano un design degli anni '60, dallo storico archivio Barovier&Toso, e ne ripropongono la sinuosità e il concetto di simmetria. Dal loro incontro nascono lampade uniche, per eleganza e fascino.

Made with the traditional Rigadin technique, the hourglasses are lined with slender ribbing, enlivening the refraction of the light. They are based on a design from the 1960s contained in the historical archives of Barovier&Toso, reinterpreting its sinuous lines and its concept of symmetry.

These factors are combined to create lamps that are unique for their elegance and charm.



Modelli e misure Models and sizes

Clepsydra
7475-00

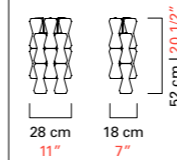

Peso Weight

9 kg
20 lb

Lampadine Bulbs

N.	Tipo	W max.
2	E14	40
	E12	40

Dimmerabile Dimmable

D

Lampadine incluse Bulbs included

Certificazioni Certification Marks

ERC

Colori disponibili Available colours



CC
Cristallo
Crystal



FE
Cristallo / Sabbia
Crystal / Sand

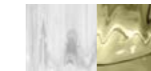

FD
Cristallo / Oliva
Crystal / Olive



FF
Cristallo / Blu Cadetto
Crystal / Cadet Blue



FP
Cristallo / Pervinca
Crystal / Periwinkle

Finiture Finishings



CL
Cromo Lucido
Polished Chrome



OG
Oro Galvanizzato
Galvanized Gold

DEGAS

Elegante ed armonica questa slanciata lampada da muro a due luci affonda le radici nello storico archivio Barovier&Toso e prende il nome da uno dei più noti impressionisti francesi.

Elegant and harmonic, this slender two-lights wall lamp, has its roots in the historical Barovier&Toso archive and it is named after one of the most famous French impressionists.



Modelli e misure Models and sizes

Degas
5554-02

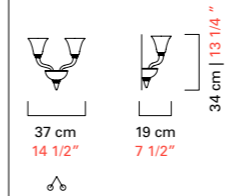

Peso

Weight

4 kg
9 lb

Lampadine

Bulbs

N.	Tipo	W max.
2	E14	60
	E12	60

Dimmerabile

Dimmable

D

Lampadine incluse

Bulbs included

Certificazioni

Certification Marks



Colori disponibili Available colours



CC
Cristallo
Crystal



IC
Grigio
Grey



EK
Sabbia
Sand



DK
Oliva
Olive



AK
Blu Cadetto
Cadet Blue



LQ
Bluastro
Bluastro



FK
Indaco
Indigo



CK
Pervinca
Periwinkle



VI
Viola
Violet



***OO**
Oro
Gold
*Solo OG
Only OG

Finiture Finishings



CL
Cromo Lucido
Polished Chrome



***OG**
Oro Galvanizzato
Galvanized Gold
*Solo OO
Only OO

DHAMAR

Questa applique è caratterizzata da pinnacoli in colore "affogato" nel cristallo e da particolari pendagli con sfere sfaccettate che ne fanno un elemento decorativo importante.

This wall sconce is characterized by colour "sunk" into crystal pinnacles and by pendants with a very unusual shape complemented by the multifaceted spheres, which conjure a compelling decorative effect.



Modelli e misure Models and sizes

Dhamar
5596-02

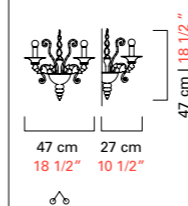

Peso Weight	7 kg 15 lb
Lampadine Bulbs	N. Tipo W max. 2 E14 60 N. Type W max. E12 60
Dimmerabile Dimmable	D
Lampadine incluse Bulbs included	
Certificazioni Certification Marks	

Colori disponibili Available colours



CC
Cristallo
Crystal



BB
Bianco
White



IC
Grigio
Grey



EK
Sabbia
Sand



DK
Oliva
Olive



LQ
Bluastro
Bluastro



FK
Indaco
Indigo



CK
Pervinca
Periwinkle



***OO**
Oro
Gold
*Solo OG
Only OG



NN
Nero
Black

Finiture Finishings



CL
Cromo Lucido
Polished Chrome



***OG**
Oro Galvanizzato
Galvanized Gold
*Solo OO
Only OO

EMPIRE

La valenza tridimensionale della lampada e il suo rigore geometrico connotano la parete con grande carattere. Gli elementi tubolari, a sezione quadrata, presentano una superficie ondulata e irregolare, ottenuta con la lavorazione a corteccia del cristallo veneziano. La luce che attraversa queste peculiari deformazioni produce un effetto luminoso soffuso e costellato da scintillii puntuali.

The three-dimensional presence of the lamp with its geometric rigour add expressive character to any wall. The tubular parts, with a square cross-section, have an undulated, irregular surface obtained with the a corteccia technique in Venetian Crystal. The light that crosses these irregular details produces a soft effect, punctuated by sparkling highlights.

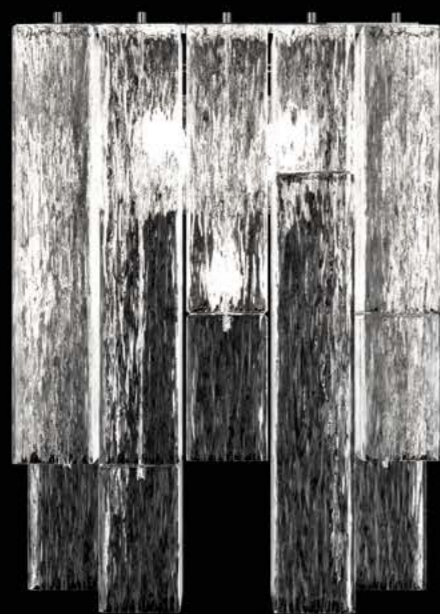

Modelli e misure Models and sizes

Empire
7465-00

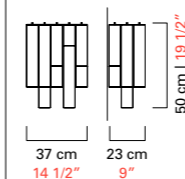

Peso Weight	17 kg 37,5 lb
Lampadine Bulbs	N. Tipo W max. 3 E14 40 N. Type W max. E12 40
Dimmerabile Dimmable	D
Lampadine incluse Bulbs included	
Certificazioni Certification Marks	ERAC

Colori disponibili Available colours



CC
Cristallo
Crystal



EE
Cristallo / Grigio / Sabbia
Crystal / Grey / Sand



ED
Cristallo / Grigio / Oliva
Crystal / Grey / Olive



EF
Cristallo / Grigio / Blu Cadetto
Crystal / Grey / Cadet Blue

Finiture Finishings



CL
Cromo Lucido
Polished Chrome



OG
Oro Galvanizzato
Galvanized Gold

EXCELSIOR

Oggetti che rimandano alla magnificenza dei grandi progetti di alberghi e navi da crociera realizzati da Barovier&Toso nella prima metà del '900. Lampade a muro di grande eleganza, proposte in suggestive e particolari finiture.

Objects that recall the magnificence of the big hospitality and cruise projects that Barovier&Toso developed during the first half of the 20th century. Extremely elegant wall sconces proposed in a distinctive range of finishes.



Modelli e misure Models and sizes

	Excelsior 5361-00	Excelsior 5362-00
	<p>21 cm 16 cm 39 cm 8 1/4" 6 1/4" 15 1/4"</p>	<p>38 cm 18 cm 40 cm 15" 7" 15 1/2"</p>
Peso Weight	6 kg 13 lb	8 kg 18 lb
Lampadine N. Tipo W max. Bulbs N. Type W max.	1 E27 60 E26 60	2 E27 60 E26 60
Dimmerabile Dimmable	D	D
Lampadine incluse Bulbs included		
Certificazioni Certification Marks		

Colori disponibili Available colours



CR
Cristallo Rugiada
Crystal Rugiada



GR
Champagne Rugiada
Champagne Rugiada



OR
Oro Rugiada
Gold Rugiada

Finiture Finishings



OG
Oro Galvanizzato
Galvanized Gold

FAUVE

Elementi caratterizzanti di questa collezione sono le foglie sottili ed allungate sapientemente lavorate dai maestri vetrai nelle nostre fornaci. Oggetti dal design pulito che si inseriscono facilmente nei contesti più variegati riuscendo ad impreziosire un angolo o una stanza.

The characteristic features of this collection are the thin extending leaves created by master craftsmen in our furnaces. Objects with a clean design, to easily insert in a wide range of contexts, enhancing a corner or an entire room.

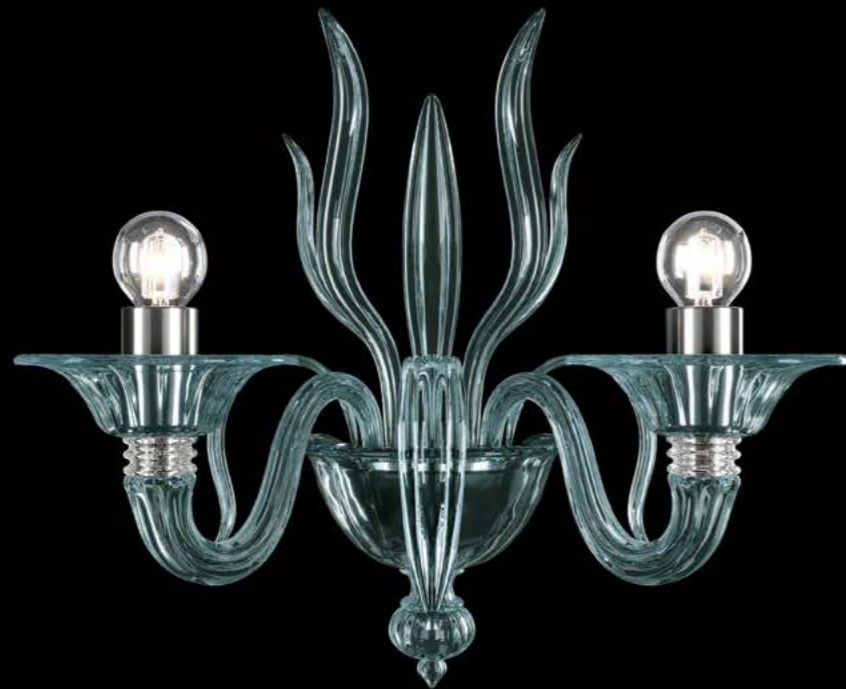

Modelli e misure Models and sizes

Fauve
5306-02

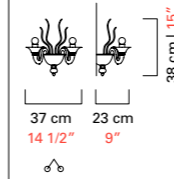

Peso
Weight 2,5 kg
6 lb

Lampadine	N.	Tipo	W max.
Bulbs	N.	Type	W max.

2	E14	60
	E12	60

Dimmerabile
Dimmable D

Lampadine incluse
Bulbs included

Certificazioni
Certification Marks



Colori disponibili Available colours



CC
Cristallo
Crystal



IC
Grigio
Grey



EK
Sabbia
Sand



DK
Oliva
Olive



AK
Blu Cadetto
Cadet Blue



LQ
Bluastro
Bluastro



FK
Indaco
Indigo



CK
Pervinca
Periwinkle



VI
Viola
Violet



***OO**
Oro
Gold
*Solo OO
Only OO

Finiture Finishings



CL
Cromo Lucido
Polished Chrome



***OG**
Oro Galvanizzato
Galvanized Gold
*Solo OO
Only OO

FEZ

Le foglie ed i pendagli a oliva caratterizzano questa applique ideale per le case moderne ma perfette anche per i palazzi più lussuosi.

Leaves and olive pendants feature in this wall lamp ideal for modern houses but also perfect for more luxurious buildings.



Modelli e misure Models and sizes

Fez

5602-02

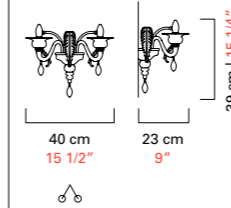

Peso

3 kg

Weight

7 lb

Lampadine

N. Tipo W max.

2 E14 60

Bulbs

N. Type W max.

E12 60

Dimmerabile

D

Dimmable

Lampadine incluse

Bulbs included

Certificazioni

Certification Marks



Colori disponibili Available colours



CC

Cristallo
Crystal

IC

Grigio
Grey

EK

Sabbia
Sand

DK

Oliva
Olive

AK

Blu Cadetto
Cadet Blue

LQ

Bluastro
Bluastro

FK

Indaco
Indigo

CK

Pervinca
Periwinkle

VI

Viola
Violet

*OO

Oro
Gold
*Solo OG
Only OG

Finiture Finishings



CL

Cromo Lucido
Polished Chrome

*OG

Oro Galvanizzato
Galvanized Gold
*Solo OO
Only OO

FLORIAN

I nostri archivi storici sono una miniera di ispirazioni: proprio da qui nasce Florian, una collezione di lampade a muro dalle linee retrò eppure così moderne, accentuate dai massicci paralumi in cristallo veneziano eseguiti con la tecnica del "rostrato", invenzione di Ercole Barovier che moltiplica i bagliori di luce e rende il lampadario un'opera di maestria unica.

Our historic archives provide a wealth of inspiration, and it was through them that the Florian design, collection of wall lamps, was conceived. The lines of Florian are so retro but at the same time so contemporary, accentuated by massive Venetian crystal lampshades created using the "rostrato" technique invented by Ercole Barovier, intensifying the sparkle of the lights and making this chandelier a unique piece of craftsmanship.



Modelli e misure Models and sizes

	Florian 5717-01	Florian 5717-02
Peso Weight	4 kg 9 lb	7 kg 15 lb
Lampadine N. Tipo W max. Bulbs N. Type W max.	1 E14 60 E12 60	2 E14 60 E12 60
Dimmerabile Dimmable	D	D
Lampadine incluse Bulbs included		
Certificazioni Certification Marks		

Colori disponibili Available colours



CC
Cristallo
Crystal

Finiture Finishings



CL
Cromo Lucido
Polished Chrome



CN
Cromo Nero
Dark Chrome



OF
Ottone
Spazzolato Fine
Fine Brushed Brass

GALLIA

Applique elegante ispirata alla regolarità del classico e resa senza tempo dai colori caldi e avvolgenti: il diffusore opalino è beige con pagliuzze dorate, mentre varia il colore dell'elemento sferico.

An elegant wall lamp inspired by regular, classical lines and rendered timeless by the warm and welcoming colours: the opaline diffuser is beige, speckled with gold, while the sphere element can be of different colours.



Modelli e misure Models and sizes

Gallia
5627-00

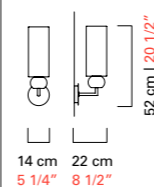

Peso Weight	4 kg 8 lb		
Lampadine Bulbs	N. N.	Tipo Type	W max. W max.
Dimmerabile Dimmable	D		
Lampadine incluse Bulbs included			
Certificazioni Certification Marks			

Colori disponibili Available colours

*A ogni colore è sempre abbinata la foglia oro.
Each colour is always combined with gold leaf.



OY
Oro Beige/ Oro
Gold Beige/ Gold



OW
Oro Beige/
Verde Oro
Gold Beige/
Green Gold



OK
Beige Oro/
Nero Oro
Gold Beige/
Black Gold

Finiture Finishings



OG
Oro Galvanizzato
Galvanized Gold



OF
Ottone
Spazzolato Fine
Fine Brushed Brass

IZMIR

Forme sinuose, pendagli in cristallo trasparente e bracci in cristallo veneziano ritorto: una combinazione ideale per esaltare la lucentezza e la matericità del vetro.

Sinuous forms, pendants in transparent crystal and arms in twisted Venetian crystal: an ideal combination to embellish the brilliance and substance of the glass.



Modelli e misure Models and sizes

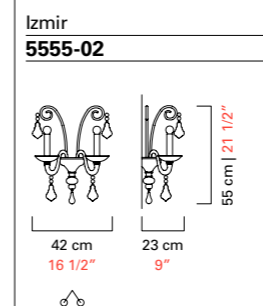

Peso Weight	2,5 kg 6 lb
Lampadine Bulbs	N. Tipo W max. N. Type W max. 2 E14 60 E12 60
Dimmerabile Dimmable	D
Lampadine incluse Bulbs included	
Certificazioni Certification Marks	

Colori disponibili Available colours

CC Cristallo Crystal	IC Grigio Grey	EK Sabbia Sand	DK Oliva Olive	AK Blu Cadetto Cadet Blue
LQ Bluastro Bluastro	FK Indaco Indigo	CK Pervinca Periwinkle	VI Viola Violet	*OO Oro Gold *Solo OG Only OG

Finiture Finishings

CL Cromo Lucido Polished Chrome	*OG Oro Galvanizzato Galvanized Gold *Solo OO Only OO

MAGRITTE

La collezione Magritte è frutto di un lavoro concettuale che indaga l'idea di lampadario fino a ripensarla e destrutturarla. Ispirata al linguaggio surrealista, si presenta con un impianto scenografico ed elegante, a più livelli, come vuole la tradizione, ma nella realtà rivela un nuovo ed avanguardistico design. La collezione include anche una versione applique, a due luci, discreta e raffinata, ideale per punteggiare le pareti di uno spazio pubblico o privato.

The Magritte collection is the result of a conceptual work that investigates the idea of a chandelier to the point of rethinking and deconstructing it. Inspired by the surrealist language, presents itself with a scenographic and elegant layout, on multiple levels, as tradition dictates, but in reality it reveals a new and avant-garde design. The collection also includes a wall sconce version with two lights; this model is discreet and refined, ideal to punctuate the walls of both public and private spaces.



Modelli e misure Models and sizes

Magritte
5721-02

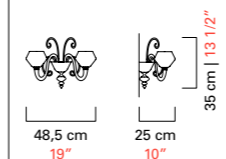

Peso Weight	5 kg 11 lb
Lampadine Bulbs	N. Tipo W max. 2 E14 60 N. Type W max. E12 60
Dimmerabile Dimmable	D
Lampadine incluse Bulbs included	
Certificazioni Certification Marks	

Colori disponibili Available colours



CC
Cristallo
Crystal



IC
Grigio
Grey



EK
Sabbia
Sand



DK
Oliva
Olive



AK
Blu Cadetto
Cadet Blue



LQ
Bluastro
Bluastro



FK
Indaco
Indigo



CK
Pervinca
Periwinkle



VI
Viola
Violet



***OO**
Oro
Gold
*Solo OG
Only OG

Finiture Finishings



CL
Cromo Lucido
Polished Chrome



***OG**
Oro Galvanizzato
Galvanized Gold
*Solo OO
Only OO

MARYLAND

I bracci molto sinuosi, il pendaglio a goccia, i paralumi eleganti: le lampade a muro Maryland riportano il pensiero agli eleganti palazzi neoclassici del Nuovo Continente.

Sleek curves for the arms, drop pendants and elegant shades: Maryland wall lamp collection recalls of Neoclassical buildings of the New World.



Modelli e misure Models and sizes

Maryland
5587-02

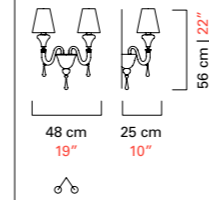

Peso Weight	3 kg 7 lb
Lampadine Bulbs	N. Tipo W max. 2 E14 60 N. Type W max. 2 E12 60
Dimmerabile Dimmable	D
Lampadine incluse Bulbs included	
Certificazioni Certification Marks	

Colori disponibili Available colours

*Per Maryland la finitura abbinata al colore OO è sempre OG.
For Maryland the finishing matching colour OO is always OG.



CC
Cristallo
Crystal



IC
Grigio
Grey



EK
Sabbia
Sand



DK
Oliva
Olive



AK
Blu Cadetto
Cadet Blue



LQ
Bluastro
Bluastro



FK
Indaco
Indigo



CK
Pervinca
Periwinkle



VI
Viola
Violet



***OO**
Oro
Gold
*Solo OG
Only OG

Finiture Finishings



CL
Cromo Lucido
Polished Chrome



***OG**
Oro Galvanizzato
Galvanized Gold
*Solo OO Maryland
Only OO Maryland

Paralumi Shades

Esterno: Cotone
External: Cotton

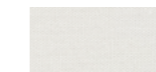
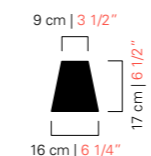

BB
Bianco
White



NN
Nero
Black



NO
Nero Interno Oro
Black Inner Gold

MATRIOSKA

Una applique caratterizzata da una montatura estremamente moderna e contemporanea. Il prezioso elemento in cristallo veneziano, chiamato "cipolla" per la sua particolare forma e per la lavorazione a costolature, diventa protagonista di un'inusuale interpretazione della lampada a muro con paralume.

A wall sconce featuring an extremely modern and contemporary assembly. The precious Venetian crystal element, known as "cipolla" due to its particular form and ribbed workmanship, becomes the protagonist of an unusual interpretation of the wall lamp with shade.



Modelli e misure Models and sizes

Matrioska
7096-01

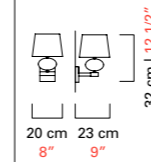

Peso Weight

2,5 kg
6 lb

Lampadine Bulbs

N.	Tipo	W max.
1	E14	60
	E12	60

Dimmerabile Dimmable

D

Lampadine incluse Bulbs included

Certificazioni Certification Marks



Colori disponibili Available colours



CC
Cristallo
Crystal



IC
Grigio
Grey



EK
Sabbia
Sand



DK
Oliva
Olive



AK
Blu Cadetto
Cadet Blue



LQ
Bluastro
Bluastro



FK
Indaco
Indigo



CK
Pervinca
Periwinkle



VI
Viola
Violet



OO
Oro
Gold

Finiture Finishings



CL
Cromo Lucido
Polished Chrome



CN
Cromo Nero
Dark Chrome



OF
Ottone
Spazzolato Fine
Fine Brushed Brass

Paralumi Shades

Esterno: Cotone
External: Cotton

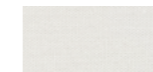
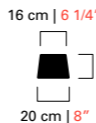

BB
Bianco
White



NN
Nero
Black



NO
Nero Interno Oro
Black Inner Gold

MEDINA

Una applique formosa, con dimensioni generose dalle linee quasi boteriane. Il collare metallico ed il paralume fuori scala caratterizzano questo oggetto.

A shapely wall sconce with generous dimensions whose design recalls somehow Botero's drawings. The metal neck and the oversize shade are distinctive of this object.



Modelli e misure Models and sizes

	Medina 5682-01	Medina 5683-01
Peso Weight	4 kg 9 lb	6 kg 13 lb
Lampadine Bulbs	N. Tipo W max. 1 E14 60	N. Tipo W max. 1 E27 100
Dimmerabile Dimmable	D	D
Lampadine incluse Bulbs included		
Certificazioni Certification Marks		

Colori disponibili Available colours

Finiture Finishings

--	--	--

Paralumi Shades

Esterno: Cotone
External: Cotton

--	--	--

MEKNES

Dall'archivio dei disegni storici di Barovier&Toso una lampada a muro della tradizione veneziana, ricca di elementi decorativi ispirati al mondo naturale. Fiori, foglie e boccioli fatti a mano rendono questo oggetto estremamente ricco e prezioso.

From the historical drawings archive of Barovier&Toso a wall lamp from the Venetian tradition, full of decorative elements inspired by nature. Hand crafted flowers, leaves and buds make this object extremely rich and precious.



Modelli e misure Models and sizes

Meknes
4797-02

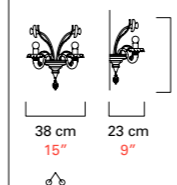

Peso Weight	3 kg 7 lb
Lampadine Bulbs	N. Tipo W max. 2 E14 60 N. Type W max. E12 60
Dimmerabile Dimmable	D
Lampadine incluse Bulbs included	
Certificazioni Certification Marks	

Colori disponibili Available colours



CC
Cristallo
Crystal



CU
Cristallo/
Decoro Bluastro
Crystal/ Bluastro
Decoration



DO
Cristallo/
Decoro Oro
Crystal/ Gold
Decoration



***OO**
Oro
Gold
*Solo OO
Only OO

Finiture Finishings



CL
Cromo Lucido
Polished Chrome



***OG**
Oro Galvanizzato
Galvanized Gold
*Solo OO
Only OO

METROPOLIS

Metropolis si ispira alle atmosfere glamour ed ammalianti degli anni '20, capaci di rievocare quel vivace fermento che investì le arti visive, il design, l'architettura e la moda dell'epoca. Attingendo a quelle vibranti tendenze estetiche, che videro New York, Mosca, Berlino e Parigi trasformarsi in capitali del lusso, del divertimento e della bella vita. Una nuova collezione affascinante e raffinata, carica di una tensione espressiva intensa e sensuale.

Metropolis takes its cue from the glamorous, seductive atmospheres of the 1920s, drawing on the lively ferment in the visual arts, design, architecture and fashion in that period. Referencing the vibrant aesthetic trends that made New York, Moscow, Berlin and Paris into worldwide capitals of luxury, entertainment and lifestyle. A new collection fascinating and refined, charged with intense and sensual expressive energy.



Modelli e misure Models and sizes

Metropolis

5720-01

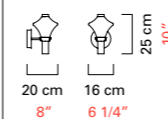

Peso Weight	3 kg 7 lb
Lampadine Bulbs	N. Tipo W max. 1+1 G9+Led 7+1,5 N. Type W max. 7+1,5
Dimmerabile Dimmable	D G9
Lampadine incluse Bulbs included	G9 Led + Led
Certificazioni Certification Marks	UL ENEC UL us

Colori disponibili Available colours



CC
Cristallo
Crystal



IC
Grigio
Grey



EK
Sabbia
Sand



DK
Oliva
Olive



AK
Blu Cadetto
Cadet Blue



LQ
Bluastro
Bluastro



FK
Indaco
Indigo



CK
Pervinca
Periwinkle



VI
Viola
Violet



OO
Oro
Gold

Finiture Finishings



NJ
Nickel Nero
Spazzolato
Brushed Black
Nickel



OJ
Oro Spazzolato
Brushed Gold

MIDTOWN

Midtown è una collezione che esprime la monumentalità del cristallo veneziano, ispirandosi all'architettura del primo '900 e ai grattacieli di Manhattan degli anni '20 e '30. Il design si distingue per una geometria scomposta, creata dall'accostamento di lastre di cristallo di diverse dimensioni, realizzate in piastra. Le superfici presentano scanalature verticali e orizzontali, conferendo al cristallo una texture zigrinata, in grado di conservare l'intensità della fonte luminosa con un leggero effetto diffuso. La moltitudine di piani sfalsati produce una connotazione decorativa che sfrutta la geometria elementare e lo spazio, attraverso un gioco di luci ed ombre, rifrazioni e schermature.

A tribute to architectural grandeur, Midtown captures the expressive power of Venetian crystal, inspired by early 20th century architecture and the iconic Manhattan skyline of the 1920s and 30s. Its design is defined by a fragmented geometry, composed of juxtaposed crystal panels of varying dimensions, precision-cut to create a sculptural effect. The surfaces feature subtle vertical and horizontal fluting, giving the glass a refined ribbed texture that retains and diffuses light with a soft, atmospheric glow. The interplay of staggered planes reinforces Midtown's decorative identity, using elemental geometry and spatial depth to create a dynamic dialogue of light and shadow, refraction and diffusion.



Modelli e misure Models and sizes

	Midtown 7590-00	Midtown 7591-00
Peso Weight	6 kg 13 lb	6 kg 13 lb
Lampadine Bulbs	N. Tipo W max. 3 Led 1,5	N. Tipo W max. 3 Led 1,5
Dimmerabile Dimmable	D	D
Lampadine incluse Bulbs included	Led	Led
Certificazioni Certification Marks		

Colori disponibili Available colours



CC
Cristallo
Crystal

Finiture Finishings



CL
Cromo Lucido
Polished Chrome



NS
Nickel Spazzolato
Brushed Nickel

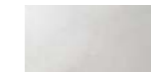

VG
Verniciato Bianco
Painted White

NEVADA

Arredare con una applique in cristallo veneziano di questa collezione significa donare eleganza e carattere agli ambienti, anche se di stili differenti. L'elemento caratterizzante sono i bracci rettilinei quasi privi di curvature dai quali pendono esili e delicati pendagli a forma di goccia.

Decorating with a wall lamp in Venetian crystal from this collection means adding elegance and character to spaces, even when their styles differ. The rectilinear arms, almost without curvature, are the characteristic feature, supporting slender, delicate dewdrop pendants.



Modelli e misure Models and sizes

Nevada
5549-02

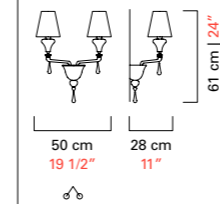

Peso
Weight

3 kg
7 lb

Lampadine N. Tipo W max.
Bulbs N. Type W max.

2 E14 60
E12 60

Dimmerabile
Dimmable

D

Lampadine incluse
Bulbs included

Certificazioni
Certification Marks



Colori disponibili Available colours

*Per Nevada la finitura abbinata al colore OO è sempre OG.
*For Nevada the finishing matching colour OO is always OG.



CC
Cristallo
Crystal



IC
Grigio
Grey



EK
Sabbia
Sand



DK
Oliva
Olive



AK
Blu Cadetto
Cadet Blue



LQ
Bluastro
Bluastro



FK
Indaco
Indigo



CK
Pervinca
Periwinkle



VI
Viola
Violet



***OO**
Oro
Gold

Finiture Finishings



CL
Cromo Lucido
Polished Chrome



***OG**
Oro Galvanizzato
Galvanized Gold
*Solo OO Nevada
Only OO Nevada

Paralumi Shades

Esterno: Cotone
External: Cotton

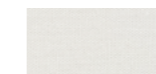
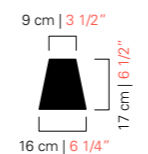

BB
Bianco
White



NN
Nero
Black



NO
Nero Interno Oro
Black Inner Gold

NEW FELCI

Per immergersi in una suggestiva atmosfera dallo stile déco, ammiccando al gusto glamour degli anni '20 e '30. Il fascino di una cascata di luce composta da brillanti e voluttuose foglie in cristallo veneziano delicatamente arricciate alle estremità.

For a plunge into an evocative Deco mood that takes its cue from the glamour of the 1920s and 1930s. The charm of a cascade of light composed of sparkling and voluptuous leaves of Venetian crystal, delicately curled at the extremities.



Modelli e misure Models and sizes

	New Felci 7238-00	New Felci 7239-00
Peso Weight	12 kg 26 lb	7 kg 15 lb
Lampadine Bulbs	N. Tipo W max. 2+1 E14+ E14 60+40 E12+ E12 60+40	N. Tipo W max. 2 E14 40 E12 40
Dimmerabile Dimmable	D	D
Lampadine incluse Bulbs included		
Certificazioni Certification Marks	ERAC	ERAC

Colori disponibili Available colours



CC
Cristallo
Crystal

Finiture Finishings



CL
Cromo Lucido
Polished Chrome



OG
Oro Galvanizzato
Galvanized Gold

ODILE

Applique in cristallo veneziano realizzate a mano dai nostri esperti maestri vetrai. Queste raffinate creazioni donano eleganza e classe ad ogni tipo di ambiente, sia classico che moderno, rappresentano l'ornamento di lusso che abbina la tradizione antica al design più moderno: vere opere d'arte per illuminare al meglio gli spazi.

Wall sconces in Venetian crystal handcrafted by our expert master glassmakers. These refined creations add elegance and class to any decor, classic or modern. They represent an approach to luxury that combines an age-old tradition with the most advanced design: true works of art to brighten all kinds of spaces.



Modelli e misure Models and sizes

Odile
5307-02

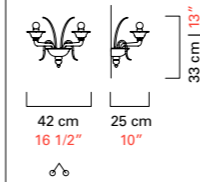

Peso Weight	2 kg 4 lb
Lampadine Bulbs	N. Tipo W max. 2 E14 60 N. Type W max. E12 60
Dimmerabile Dimmable	D
Lampadine incluse Bulbs included	
Certificazioni Certification Marks	

Colori disponibili Available colours



CC
Cristallo
Crystal



IC
Grigio
Grey



EK
Sabbia
Sand



DK
Oliva
Olive



AK
Blu Cadetto
Cadet Blue



LQ
Bluastro
Bluastro



FK
Indaco
Indigo



CK
Perivinca
Periwinkle



VI
Viola
Violet



***OO**
Oro
Gold
*Solo OG
Only OG

Finiture Finishings



CL
Cromo Lucido
Polished Chrome



***OG**
Oro Galvanizzato
Galvanized Gold
*Solo OO
Only OO

OPÉRA

Philippe Nigro

Opéra è una collezione di lampade ispirata all'Opéra Garnier, in cui l'elemento principale è la lavorazione del rostrato. La forma cilindrica va ad enfatizzare il motivo ornamentale, moltiplicando gli angoli di incidenza dei raggi luminosi e creando un fitto involuppo di punte tridimensionali. Alle creazioni in Cristallo Veneziano sono abbinati elementi metallici dalla silhouette molto affine, che circondano e sostengono i corpi luminosi. La versione applique si sviluppa in senso verticale ed è perfetta per valorizzare una parete e punteggiarla di accenti luminosi.

Opéra is a collection of lamps inspired by the Opéra Garnier, where the main feature is the rostrato. The cylindrical form underscores the ornamental motif, multiplying the angles of impact of beams of light and creating a dense wrapping of three-dimensional points. The creations in Venetian Crystal are joined by metal parts with a very similar silhouette, which surround and support the luminous volumes: completely different textures, sharing a specific inspiration in their shapes and substance. The wall sconce version develops vertically and is perfect to enhance walls, punctuating them with luminous accents.



Modelli e misure Models and sizes

Opéra

7389-00

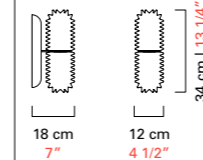

Peso

Weight

6 kg
13 lb

Lampadine

Bulbs

N.	Tipo	W max.
1	Strip Led	12

Strip Led 12

Dimmerabile

Dimmable

D

Lampadine incluse

Bulbs included

Strip Led

Certificazioni

Certification Marks



Colori disponibili

Available colours



CC

Cristallo
Crystal

Finiture

Finishings



NJ

Nickel Nero
Spazzolato
Brushed Black
Nickel



OJ

Oro Spazzolato
Brushed Gold

PALLADIANO

Simmetria, ordine, perfezione ed eleganza sono le muse ispiratrici di questa collezione. Un omaggio alla razionalità e all'equilibrio delle opere del Palladio ed ai valori dell'architettura formale classica. Anche la scelta della palette cromatica con i suoi colori pieni, non trasparenti, è una celebrazione della matericità e del volume dell'oggetto che si trasforma quasi, esso stesso, in una piccola architettura.

Symmetry, order, perfection and elegance are the muses behind this collection. A tribute to the rationality and balance of the works of Palladio, and the values of formal classical architecture. The selection of colours, in full, non-transparent hues, is a celebration of the material and volume of the object, which is transformed almost into a small work of architecture.



Modelli e misure Models and sizes

Palladiano
5600-02

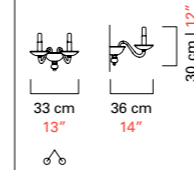

Peso Weight	4 kg 9 lb		
Lampadine Bulbs	N. N.	Tipo Type	W max. W max.
Dimmerabile Dimmable	D		
Lampadine incluse Bulbs included			
Certificazioni Certification Marks			

Colori disponibili Available colours



CC
Cristallo
Crystal



BB
Bianco
White



NN
Nero
Black

Finiture Finishings



CL
Cromo Lucido
Polished Chrome

PALMETTE

Una collezione che si distingue per la preziosità delle lavorazioni, rigorosamente realizzate artigianalmente e frutto di una ricerca stilistica che attinge alla storia per darne una interpretazione in chiave contemporanea. Ventagli in foglie di cristallo, sovrapposti per una rilettura intrigante dello stile déco.

A collection that stands out for precious workmanship rigorously done by hand, result of stylistic research that draws on history, granting it a contemporary interpretation. Fans of crystal leaves for an intriguing take on Art Deco.



Modelli e misure Models and sizes

Palmette
7500-00

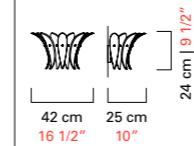

Peso

4 kg

Weight

9 lb

Lampadine	N.	Tipo	W max.		
Bulbs	N.	Type	W max.		
	1			E14	60
				E12	40

1

E14

60

E12

40

Dimmerabile

D

Dimmable

Lampadine incluse

Bulbs included

Certificazioni

Certification Marks



Colori disponibili

Available colours



CC

Cristallo
Crystal

Finiture

Finishings



CL

Cromo Lucido
Polished Chrome



OG

Oro Galvanizzato
Galvanized Gold

PANDORA

Regala leggerezza ed un aspetto fiabesco agli interni grazie ai bracci in cristallo veneziano che sembrano fluttuare nell'aria. Il suo aspetto simile a quello di una medusa crea divertenti giochi di luce che donano profondità agli ambienti, ed il suo paralume di dimensioni importanti genera un'illuminazione omogenea ed elegante.

Interiors take on a light, fairy-tale image thanks to arms of Venetian crystal that seem to float in the air. The resemblance to a jellyfish suggests playful games of light that add depth to spaces, while the large shade generates uniform, elegant light.



Modelli e misure Models and sizes

Pandora
5675-02

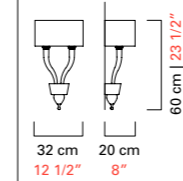

Peso Weight	3 kg 7 lb
Lampadine Bulbs	N. Tipo W max. 2+1 E14+Led 40+1,2 N. Type W max. E12+Led 40+1,2
Dimmerabile Dimmable	D E14
Lampadine incluse Bulbs included	Led
Certificazioni Certification Marks	

Colori disponibili Available colours



CC
Cristallo
Crystal



IC
Grigio
Grey



EK
Sabbia
Sand



DK
Oliva
Olive



AK
Blu Cadetto
Cadet Blue



LQ
Bluastro
Bluastro



FK
Indaco
Indigo



CK
Pervinca
Periwinkle



VI
Viola
Violet



OO
Oro
Gold

Finiture Finishings



CL
Cromo Lucido
Polished Chrome



CN
Cromo Nero
Dark Chrome

Paralumi Shades

Esterno: Cotone
External: Cotton



BB
Bianco
White



NN
Nero
Black



NO
Nero Interno Oro
Black Inner Gold

PERSEUS

Marcel Wanders

Una scultura luminosa, un'emozione di luce, agli antipodi del classico. Composta da diversi elementi in cristallo veneziano che rappresentano un mix delle tecniche vetrarie reinterpretate, accostate e mescolate in modo sovversivo rispetto ai canoni della classicità.

An illuminated sculpture, a lighting emotion, a world away from the classic style. It is composed of a number of Venetian crystal elements that represent a mix of the glassmaking techniques reinterpreted, paired, and mixed in a subversive way with respect to the canons of classicism.



Modelli e misure Models and sizes

Perseus
7312-00

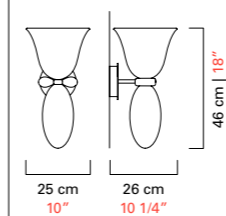

Peso Weight	4 kg 9 lb
Lampadine Bulbs	N. Tipo W max. N. Type W max. 2 G9 40 2 G9 40
Dimmerabile Dimmable	D
Lampadine incluse Bulbs included	G9 Led
Certificazioni Certification Marks	ERAC

Colori disponibili Available colours



BE
Bianco / Cristallo /
Cedro Liquido
White / Crystal /
Liquid Citron



BZ
Bianco / Cristallo /
Cognac
White / Crystal /
Cognac

Finiture Finishings



CL
Cromo Lucido
Polished Chrome

PIGALLE

Tradizione ed innovazione si fondono in questa collezione ispirata alla Belle Époque. Si caratterizza per eleganza e linee sinuose senza risultare eccessiva ed ostentata. Eloquente per raffinatezza e grazia alterna linee semplici, dettagli curvi e lavorazioni tradizionali.

Tradition and innovation blend in this collection inspired by the Belle Époque. It stands out for its elegant, sinuous lines, without ever seeming excessive or ostentatious. With its eloquent refinement and grace, it mixes simple lines, curved details and traditional workmanship.



Modelli e misure Models and sizes

	Pigalle 5680-01	Pigalle 5680-02
Peso Weight	4 kg 9 lb	5 kg 11 lb
Lampadine Bulbs	N. Tipo W max. 1+1 Led 8,4+8,4 8,4+8,4	N. Tipo W max. 2+1 Led 8,4+8,4 8,4+8,4
Dimmerabile Dimmable		
Lampadine incluse Bulbs included	Led	Led
Certificazioni Certification Marks		

Colori disponibili Available colours



BC
Bianco/ Cristallo
White/ Crystal



OY
Oro Beige/ Oro
Gold Beige/ Gold

Finiture Finishings



CL
Cromo Lucido
Polished Chrome



CN
Cromo Nero
Dark Chrome



OJ
Oro Spazzolato
Brushed Gold

PIUME

Riprese dai disegni degli anni '20 e '30 del nostro archivio storico, queste applique sono un omaggio allo stile Déco. Con le loro ricche piume evocano ambientazioni lussuose e ricercate. Adatte ad ambienti estremamente decorati come anche, per contrasto, ad interni più minimali.

Resumed from drawings of the 20ies and 30ies from our historical archive, these wall lamps pay a tribute to the Déco era. With their rich feathers they evoke luxurious and refined settings. Perfect for extremely decorated ambiances as well as, playing with contrasts, for more minimal interior design projects.



Modelli e misure Models and sizes

	Piume 5390-00	Piume 5391-00	Piume 5392-00
Peso Weight	6 kg 13 lb	10 kg 22 lb	20 kg 44 lb
Lampadine Bulbs	N. Tipo W max. 1 E27 100	N. Tipo W max. 2 E27 60	N. Tipo W max. 4 E27 60
Dimmerabile Dimmable	D	D	D
Lampadine incluse Bulbs included			
Certificazioni Certification Marks			

Colori disponibili Available colours



OB
Oro Beige
Beige Gold

Finiture Finishings



OG
Oro Galvanizzato
Galvanized Gold

PLISSÉ

Una applique direttamente ispirata dalla tradizione. Gli elementi in cristallo veneziano sono realizzati grazie a una tecnica brevettata da Barovier&Toso, che consente di ottenere un effetto striato regolare che alterna il colore pieno a quello trasparente.

A wall sconce directly inspired by the tradition. A technique patented by Barovier&Toso that allows to obtain a regular striped effect alternating matt and transparent colours on the Venetian crystal elements.



Modelli e misure Models and sizes

Plissé

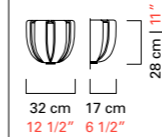
6703-00**Peso**

4 kg

Weight

9 lb

Lampadine

N. Tipo W max. 2 E14 60

Bulbs

N. Type W max. E12 60

Dimmerabile

D

Dimmable**Lampadine incluse****Bulbs included****Certificazioni****Certification Marks****Colori disponibili****Available colours****BB**

Bianco

White

Finiture**Finishings****VG**

Verniciato Bianco

Painted White

PREMIÈRE DAME

L'opulenza delle forme e dei dettagli rifulge nei pendagli di queste applique, degne delle più importanti, sontuose e ricercate dimore francesi. Con una ricchezza decorativa molto sofisticata, questa collezione si caratterizza per le diverse lavorazioni del cristallo veneziano e dei pendagli di fattura originale.

The opulence of shapes and details radiates in the pendants of these wall sconces, worthy of the most important, sumptuous and refined French residences. With its richly decorated and sophisticated design this collection is characterized by different Venetian crystal craftworks and an original pendants fabrication.



Modelli e misure Models and sizes

	Première Dame 5696-01	Première Dame 5696-02
Peso Weight	3 kg 7 lb	4 kg 9 lb
Lampadine Bulbs	N. Tipo W max. 1 E14 60	N. Tipo W max. 2 E14 60
Dimmerabile Dimmable	D	D
Lampadine incluse Bulbs included		
Certificazioni Certification Marks		

Colori disponibili Available colours



CC
Cristallo
Crystal



BB
Bianco
White



IC
Grigio
Grey



EK
Sabbia
Sand



DK
Oliva
Olive



LQ
Bluastro
Bluastro



FK
Indaco
Indigo



CK
Pervinca
Periwinkle



***OO**
Oro
Gold
*Solo OG
Only OG



NN
Nero
Black

Finiture Finishings



CL
Cromo Lucido
Polished Chrome



***OG**
Oro Galvanizzato
Galvanized Gold
*Solo OO
Only OO

Paralumi Shades

Nastro Pongè
Pongee Ribbon

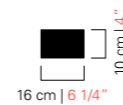

BB
Bianco
White



NN
Nero
Black

PRÉSIDENT

Applique iconiche che mettono in risalto la meticolosa eleganza della lavorazione artigianale. Prismi cesellati, pendenti scintillanti e coppette decorate le rendono elementi d'arredo davvero unici in cui il cristallo veneziano rivela il suo splendore scultoreo.

Iconic wall sconces that proudly display their painstaking workmanship and elegance. Chiselled prisms, sparkling pendants and decorated cups make this a truly unique decor feature, in which Venetian crystal reveals its sculptural splendour.



Modelli e misure Models and sizes

	Président 5695-01	Président 5695-02
Peso Weight	3 kg 7 lb	4 kg 9 lb
Lampadine Bulbs	N. Tipo W max. 1 E14 60 E12 60	N. Tipo W max. 2 E14 60 E12 60
Dimmerabile Dimmable	D	D
Lampadine incluse Bulbs included		
Certificazioni Certification Marks		

Colori disponibili Available colours



CC
Cristallo
Crystal



BB
Bianco
White



IC
Grigio
Grey



EK
Sabbia
Sand



DK
Oliva
Olive



LQ
Bluastro
Bluastro



FK
Indaco
Indigo



CK
Pervinca
Periwinkle



***OO**
Oro
Gold
*Solo OO
*Only OO



NN
Nero
Black

Finiture Finishings



CL
Cromo Lucido
Polished Chrome



***OG**
Oro Galvanizzato
Galvanized Gold
*Solo OO
*Only OO

Paralumi Shades

Esterno: Cotone
External: Cotton

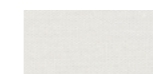
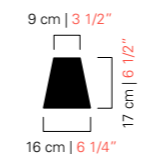

BB
Bianco
White



NN
Nero
Black



NO
Nero Interno Oro
Black Inner Gold

RABAT

Una applique classica, che utilizza molti degli stilemi della tradizione veneziana. In particolare, le "morise", decorazioni ondulate eseguite applicando a caldo un cordoncino di vetro pizzicato con le "borselle" (pinze) da "pissegar" (pizzicare) che consentono di ottenere una superficie che sembra un merletto.

A classical wall lamp that features many of the stylistic elements of the Venetian tradition. In particular the "morise," wavy decorations executed by applying a hot crystal ribbon and then pinching it with the "borselle" (pincers) to "pissegar" (pinching) to obtain a texture that looks like a lace.



Modelli e misure Models and sizes

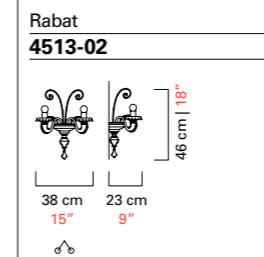

Peso Weight	3 kg 7 lb		
Lampadine Bulbs	N.	Tipo	W max.
	2	E14	60
		E12	60
Dimmerabile Dimmable	D		
Lampadine incluse Bulbs included			
Certificazioni Certification Marks			

Colori disponibili Available colours



CC
Cristallo
Crystal



CU
Cristallo/
Decoro Bluastro
Crystal/ Bluastro
Decoration



DO
Cristallo/
Decoro Oro
Crystal/ Gold
Decoration



***OO**
Oro
Gold
*Solo OO
Only OO

Finiture Finishings



CL
Cromo Lucido
Polished Chrome



***OG**
Oro Galvanizzato
Galvanized Gold
*Solo OO
Only OO

RAN ROUND

Trasparenza e leggerezza. Grazie ai bracci dalle ampie curvature, alle ogive soffiare in serie e ad i pendagli a goccia di grandi dimensioni l'appliche acquisisce una straordinaria lievità e delicatezza.

Transparency and lightness. Thanks to the wide curves of the arms, the mouth blown ogives aligned in series and the extra size drop-shaped pendants, the wall sconce appears extremely slight and delicate.



Modelli e misure Models and sizes

Ran Round
7176-02

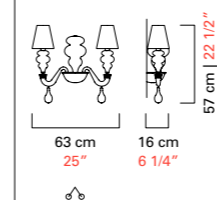

Peso Weight	4 kg 9 lb
Lampadine Bulbs	N. Tipo W max. 2 E14 60
Dimmerabile Dimmable	D
Lampadine incluse Bulbs included	
Certificazioni Certification Marks	

Colori disponibili Available colours



CC
Cristallo
Crystal



IC
Grigio
Grey



EK
Sabbia
Sand



DK
Oliva
Olive



AK
Blu Cadetto
Cadet Blue



LQ
Bluastro
Bluastro



FK
Indaco
Indigo



CK
Pervinca
Periwinkle



VI
Viola
Violet



***OO**
Oro
Gold
*Solo OG
Only OG

Finiture Finishings



CL
Cromo Lucido
Polished Chrome



***OG**
Oro Galvanizzato
Galvanized Gold
*Solo OO
Only OO

Paralumi Shades

Esterno: Cotone
External: Cotton

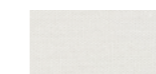
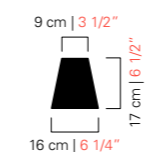

BB
Bianco
White



NN
Nero
Black

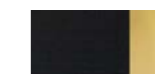

NO
Nero Interno Oro
Black Inner Gold

REX

Petali preziosi ed elaborati che grazie all'utilizzo della tecnica della "rugiada" sembrano dei merletti fatti a mano. Applique spesso scelte all'inizio del '900 per grandi progetti di navi da crociera e alberghi di lusso sono ancora oggi dei pezzi unici capaci di donare un tocco retrò anche a progetti più contemporanei.

Precious and elaborated petals that thanks to the "rugiada" technique seem handmade laces. These wall lamps were very common at the beginning of the 20th century in big cruises and luxury hotels projects but nowadays they are still unique pieces capable to give a retrò touch also to more contemporary projects.



Modelli e misure Models and sizes

Rex
5388-00

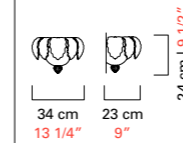

Peso Weight

5 kg
11 lb

Lampadine Bulbs

N.	Tipo	W max.
1	E27	100
	E26	60

Dimmerabile Dimmable

D

Lampadine incluse Bulbs included

Certificazioni Certification Marks



Colori disponibili Available colours



CR
Cristallo Rugiada
Crystal Rugiada



GR
Champagne Rugiada
Champagne Rugiada



OR
Oro Rugiada
Gold Rugiada

Finiture Finishings



OF
Ottone
Spazzolato Fine
Fine Brushed Brass

RIYADH

Di grande impatto scenografico, la lampada da muro Riyadh è ricca di elementi decorativi e lavorazioni a mano complesse. Un tributo al sapiente lavoro dei nostri esperti maestri vetrai. Foglie, pendagli, bossette e coppette si susseguono incessantemente in un intreccio quasi caotico per dar vita ad un disegno perfetto.

Making a highly dramatic impact, the Riyadh wall lamp is rich of decorative elements and complex handcrafted techniques. A tribute to our expert glass masters' skills. Leaves, pendants, "bossette" and cups come into an intricate, almost chaotic, succession to give birth to a perfect design.



Modelli e misure Models and sizes

Riyadh
5349-02

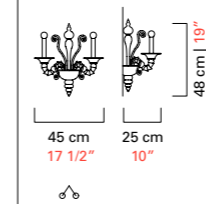

Peso
Weight

7 kg
16 lb

Lampadine N. Tipo W max.
Bulbs N. Type W max.

2 E14 60
E12 60

Dimmerabile
Dimmable

D

Lampadine incluse
Bulbs included

Certificazioni
Certification Marks



Colori disponibili Available colours



CC
Cristallo
Crystal



BB
Bianco
White



IC
Grigio
Grey



EK
Sabbia
Sand



DK
Oliva
Olive



LQ
Bluastro
Bluastro



FK
Indaco
Indigo



CK
Pervinca
Periwinkle



***OO**
Oro
Gold
*Solo OG
Only OG



NN
Nero
Black

Finiture Finishings



CL
Cromo Lucido
Polished Chrome



***OG**
Oro Galvanizzato
Galvanized Gold
*Solo OO
Only OO

ROSATI

Questa applique nasce attingendo ai disegni del prezioso archivio storico di Barovier&Toso rielaborati e riproposti con un design più moderno. Linee sobrie ed eleganti, che vanno al di là delle mode. Ogni tazza ospita al suo interno un "rostrato", piccolo gioiello di invenzione, che protegge alla vista la lampadina la cui luce si moltiplica all'infinito, passando attraverso le cuspidi che sono l'essenza stessa del rostrato.

This wall sconce takes its cue from drawings conserved in the precious historical archives of Barovier&Toso, reworked and reformulated with a more modern design. Simple, elegant lines that transcend fashion. Each candle cup holds a little stroke of genius: a "rostrato," a piece of glass with extruded pointed tips, which hides the lamps from view. Their light is refracted infinitely as it passes through the glass tips that are at the heart of the "rostrato" technique.



Modelli e misure Models and sizes

Rosati
5716-02

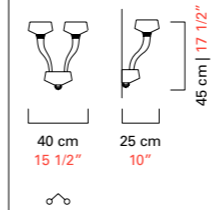

Peso Weight	5 kg 11 lb
Lampadine Bulbs	N. Tipo W max. 2+1 G9+G4 40+1,5 N. Type W max.
Dimmerabile Dimmable	D
Lampadine incluse Bulbs included	G9 Led + G4 Led
Certificazioni Certification Marks	UL EAC c UL us

Colori disponibili Available colours



CC
Cristallo
Crystal



IC
Grigio
Grey



EK
Sabbia
Sand



DK
Oliva
Olive



AK
Blu Cadetto
Cadet Blue



LQ
Bluastro
Bluastro



FK
Indaco
Indigo



CK
Pervinca
Periwinkle



VI
Viola
Violet



***OO**
Oro
Gold
*Solo OG
Only OG

Finiture Finishings



CL
Cromo Lucido
Polished Chrome



***OG**
Oro Galvanizzato
Galvanized Gold
*Solo OO
Only OO

ROTTERDAM

Bracci curvati verso l'alto e rocchetti di cristallo creati artigianalmente utilizzando un brevetto Barovier&Toso: il "rostrato". Oggetto prezioso, di straordinaria eleganza e raffinatezza capace di soddisfare un cliente esigente e sofisticato.

Arms curving upward and crystal spoons created by hand using a Barovier&Toso patent: "rostrato". A precious object of extraordinary elegance and refinement, capable of satisfying the most demanding and sophisticated customers.



Modelli e misure Models and sizes

Rotterdam
5563-02

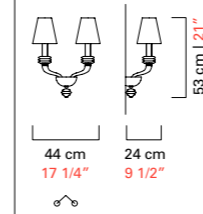

Peso Weight

4 kg
9 lb

Lampadine Bulbs

N.	Tipo	W max.
2	E14	60
	E12	60

Dimmerabile Dimmable

D

Lampadine incluse Bulbs included

Certificazioni Certification Marks



Colori disponibili Available colours



CC
Cristallo
Crystal



IC
Grigio
Grey



EK
Sabbia
Sand



DK
Oliva
Olive



AK
Blu Cadetto
Cadet Blue



LQ
Bluastro
Bluastro



FK
Indaco
Indigo



CK
Pervinca
Periwinkle



VI
Viola
Violet



***OO**
Oro
Gold
*Solo OO
Only OO

Finiture Finishings



CL
Cromo Lucido
Polished Chrome



***OG**
Oro Galvanizzato
Galvanized Gold
*Solo OO
Only OO

Paralumi Shades

Esterno: Cotone
External: Cotton

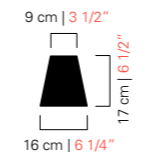

BB
Bianco
White



NN
Nero
Black



NO
Nero Interno Oro
Black Inner Gold

SAINT GERMAIN

Giorgia Brusemini

Una applique di dimensioni contenute che non perde tuttavia la poesia e l'incanto di un prodotto interamente realizzato a mano in cristallo veneziano. Elemento distintivo è la sfera realizzata con la tecnica dell'oro sommerso.

A wall sconce of compact size that do not, however, lose any of its poetry and enchantment. A product made entirely by hand in Venetian crystal, featuring a distinctive sphere made with the "oro sommerso" technique.



Modelli e misure Models and sizes

Saint Germain
7060-01

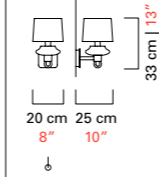

Peso Weight	4 kg 9 lb		
Lampadine Bulbs	N.	Tipo	W max.
	1	E14	60
		E12	60
Dimmerabile Dimmable	D		
Lampadine incluse Bulbs included			
Certificazioni Certification Marks			

Colori disponibili Available colours



CC
Cristallo
Crystal

Finiture Finishings



CL
Cromo Lucido
Polished Chrome



OG
Oro Galvanizzato
Galvanized Gold

Paralumi Shades

Esterno: Cotone
External: Cotton

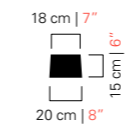

BB
Bianco
White



NN
Nero
Black



NO
Nero Interno Oro
Black Inner Gold

SAN GIORGIO

Una applique ricca di decorazioni molto particolari come i pendagli soffiati a forma di ampolla nella stessa colorazione dei bracci e le piramidi (punte attorcigliate).

Wall sconce full of specific decorations such as the ampoule shaped pendants, mouth blown in the same colour of the arms, and the pyramids (curled points).



Modelli e misure Models and sizes

San Giorgio
5558-02

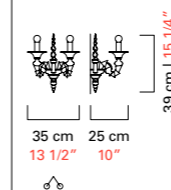

Peso Weight	2,5 kg 6 lb
Lampadine Bulbs	N. Tipo W max. 2 E14 60
Dimmerabile Dimmable	D
Lampadine incluse Bulbs included	
Certificazioni Certification Marks	

Colori disponibili Available colours



CC
Cristallo
Crystal



BB
Bianco
White



IC
Grigio
Grey



EK
Sabbia
Sand



DK
Oliva
Olive



LQ
Bluastro
Bluastro



FK
Indaco
Indigo



CK
Pervinca
Periwinkle



***OO**
Oro
Gold
*Solo OG
Only OG



NN
Nero
Black

Finiture Finishings



CL
Cromo Lucido
Polished Chrome



***OG**
Oro Galvanizzato
Galvanized Gold
*Solo OO
Only OO

SPADE

Collezione di applique ispirata ai fiori e alla natura che si contraddistingue per il suo delicato design a forma di corolla, realizzata con la tecnica della "rugiada" che dona un raffinato effetto ricamato. I petali si sovrappongono come a formare dei fiori schiusi, sospesi sul muro.

A collection of wall lamps with an accent on flowers and nature, which stands out for its delicate design in the form of a corolla, made with the "rugiada" technique to create a refined embroidered look. Petals overlap to form the image of a blossoming flower, suspended on the wall.



Modelli e misure Models and sizes

Spade

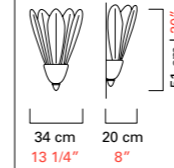
6747-00**Peso**

7 kg

Weight

15 lb

Lampadine

N. Tipo W max.

3

E14

60

Bulbs

N. Type W max.

E12

60

Dimmerabile

D

Dimmable**Lampadine incluse****Bulbs included****Certificazioni****Certification Marks****Colori disponibili****Available colours****CR**Cristallo Rugiada
Crystal Rugiada**Finiture****Finishings****CL**Cromo Lucido
Polished Chrome**OG**Oro Galvanizzato
Galvanized Gold**OF**Ottone
Spazzolato Fine
Fine Brushed Brass

TAIF

Sintesi perfetta di esperienze e materiali diversi, che sbalordisce per la sua ineguagliabile armonia. Una collezione di lampade da muro di grande successo, usate per arredi prestigiosi, che nasce nel 1980 per illuminare la residenza del re saudita a Taif, città da cui prende il nome. Angelo Barovier, che studia il progetto, ripensa l'immagine della tradizione muranese, preservando il valore del cristallo veneziano e accogliendo nuovi linguaggi per approdare infine all'equilibrio compiuto del Classico.

The perfect synthesis of experience and selected materials wrought with stunning and unequalled harmony. Taif was created in 1980 for the home of the Saudi king in the eponymous city of Taif, whence comes the name. Angelo Barovier, who conceived the design, rethought the image of the traditional Murano wall sconces, preserving the value of Venetian crystal while incorporating new languages. An amalgam, then, of tradition and creativity, of memory and innovation, from which blossoms the time-tested equilibrium of the classical.



Modelli e misure Models and sizes

	Taif 5350-02	Taif 5350-05
Peso Weight	7 kg 15 lb	11 kg 24 lb
Lampadine Bulbs	N. Tipo W max. 2 E14 60	N. Tipo W max. 5 E14 60
Dimmerabile Dimmable	D	D
Lampadine incluse Bulbs included		
Certificazioni Certification Marks		

Colori disponibili Available colours

*Per Taif la finitura abbinata al colore OO è sempre OG.
For Taif the finishing matching colour OO is always OG.



CC
Cristallo
Crystal



BB
Bianco
White



IC
Grigio
Grey



EK
Sabbia
Sand



DK
Oliva
Olive



LQ
Bluastro
Bluastro



FK
Indaco
Indigo



CK
Pervinca
Periwinkle



***OO**
Oro
Gold
*Solo OG
Only OG



NN
Nero
Black

Finiture Finishings



CL
Cromo Lucido
Polished Chrome



***OG**
Oro Galvanizzato
Galvanized Gold
*Solo OO
Only OO

TANGERI

Sfere riccamente decorate e pastorali abilmente ritorti si alternano in questa applique che attinge alla tradizione ma il cui disegno, alleggerito e semplificato, ben si adatta sia ad interni di gusto classico che contemporaneo.

Richly decorated spheres and gracefully curled pastorals alternate in this wall sconce that draws on the tradition while, lightening and simplifying the design, makes it perfect for both classic and contemporary settings.



Modelli e misure Models and sizes

Tangeri
5604-02

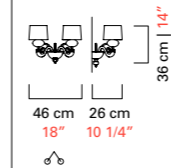

Peso
Weight

5 kg
11 lb

Lampadine N. Tipo W max.
Bulbs N. Type W max.

2 E14 60
E12 60

Dimmerabile
Dimmable

D

Lampadine incluse
Bulbs included

Certificazioni
Certification Marks



Colori disponibili Available colours



CC
Cristallo
Crystal



IC
Grigio
Grey



EK
Sabbia
Sand



DK
Oliva
Olive



AK
Blu Cadetto
Cadet Blue



LQ
Bluastro
Bluastro



FK
Indaco
Indigo



CK
Pervinca
Periwinkle



VI
Viola
Violet



***OO**
Oro
Gold
*Solo OG
Only OG

Finiture Finishings



CL
Cromo Lucido
Polished Chrome



***OG**
Oro Galvanizzato
Galvanized Gold
*Solo OO
Only OO

Paralumi Shades

Esterno: Cotone
External: Cotton

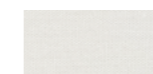
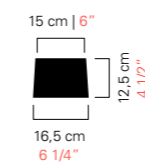

BB
Bianco
White



NN
Nero
Black



NO
Nero Interno Oro
Black Inner Gold

TORVIK

Una lampada da muro dal disegno classico e tradizionale che richiama le fiaccole dell'antica Grecia. Uno stelo allungato arricchito da costolature sorregge una coppetta che nasconde la fonte luminosa. Una preziosa perla funge da elemento terminale.

A wall lamp with a classical and traditional design that recalls the torches of ancient Greece. A stretched stem, enriched by the ribbing of the surface, supports a cup that hides the light source. A precious pearl serves as final element.



Modelli e misure Models and sizes

Torvik
5656-00

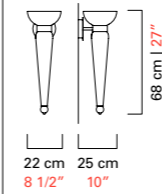

Peso Weight

4 kg
9 lb

Lampadine Bulbs

N.	Tipo	W max.			
1	E14	100			
	E12	60			

Dimmerabile Dimmable

D

Lampadine incluse Bulbs included

Certificazioni Certification Marks



Colori disponibili Available colours



OY

Oro Beige/ Oro
Gold Beige/ Gold

Finiture Finishings



OG

Oro Galvanizzato
Galvanized Gold



OF

Ottone
Spazzolato Fine
Fine Brushed Brass

TUILERIES

Con una forma moderna resa tradizionale dalla tecnica della "rugiada", brevettata nel XX secolo da Barovier&Toso, Tuileries è una lampada da parete infinita: la sua perfetta simmetria consente di creare composizioni illimitate di elementi illuminati e non, sempre perfettamente combinati tra loro ed arricchiti dalla struttura metallica spazzolata in un caldo colore bronzo miele. La personalizzazione è massima, consentendo di arrivare a coprire pareti intere, quasi come un rivestimento.

With its modern form made more traditional using the "rugiada" technique, patented in the 20th century by Barovier&Toso, Tuileries is an infinite wall lamp: its perfect symmetry enables the creation of endless compositions of illuminated and non illuminated elements, always perfectly arranged and enriched by the brushed metallic structure with its warm honey bronze colour. The opportunities for personalization are limitless, allowing entire walls to be covered, almost as a sort of luxury paneling.

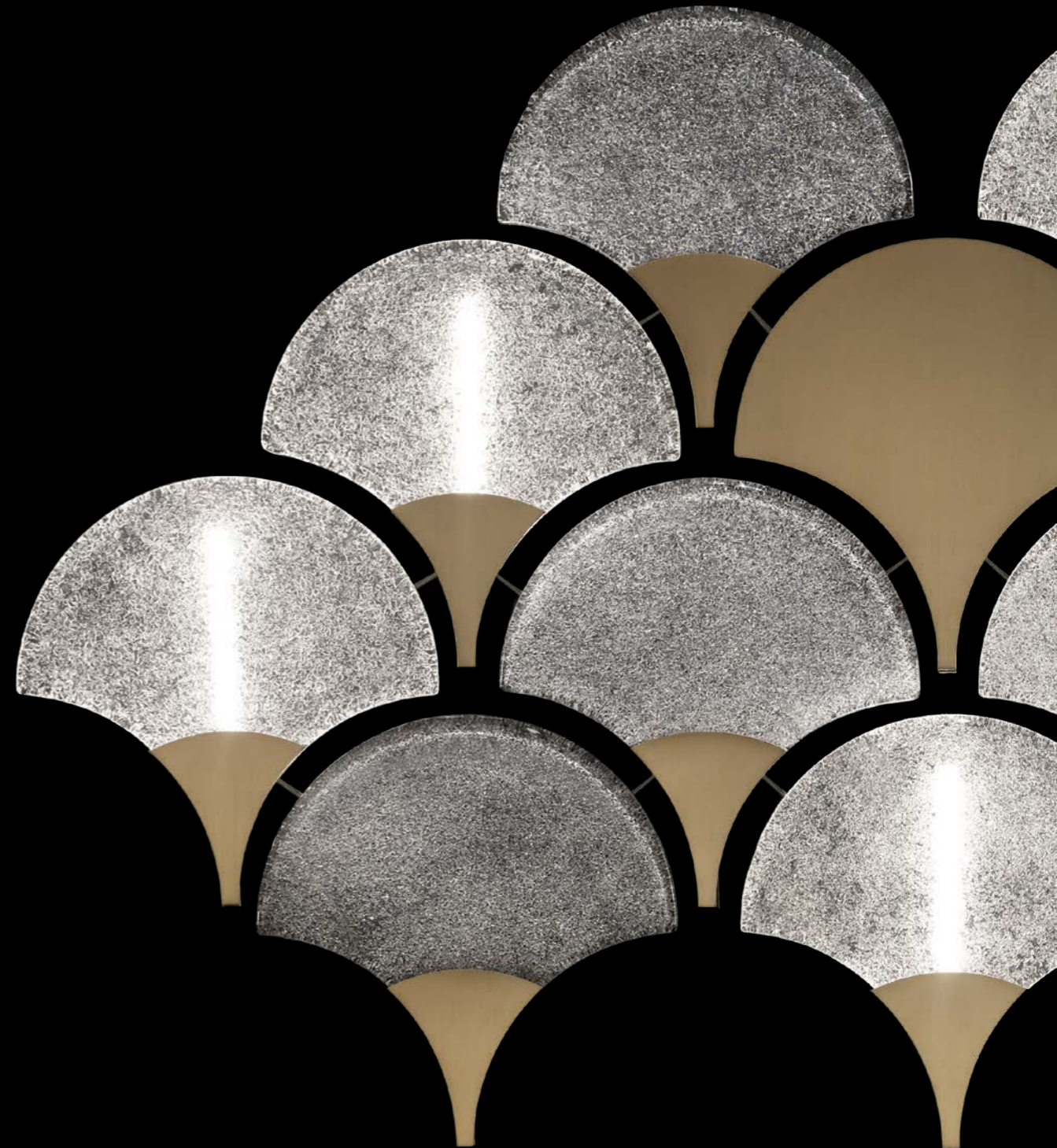

Modelli e misure
Models and sizes

	Tuileries 7373-00	Tuileries 7374-00	Tuileries 7375-00	Tuileries 7376-00
Peso Weight	6 kg 13 lb	10 kg 22 lb	17 kg 37 lb	23 kg 51 lb
Lampadine N. Tipo W max. Bulbs N. Type W max.	2 Strip Led 2,5 2,5	3 Strip Led 2,5 2,5	5 Strip Led 2,5 2,5	7 Strip Led 2,5 2,5
Dimmerabile Dimmable				
Lampadine incluse Bulbs included	Strip Led	Strip Led	Strip Led	Strip Led
Certificazioni Certification Marks	ERAC	ERAC	ERAC	ERAC

Colori disponibili
Available colours

CR
 Cristallo Rugiada
 Crystal Rugiada

Finiture
Finishings

OZ
 Bronzo Miele
 Honey Bronze

Modelli e misure
Models and sizes

	Tuileries 7377-00
Peso Weight	33 kg 73 lb
Lampadine N. Tipo W max. Bulbs N. Type W max.	9 Strip Led 2,5 2,5
Dimmerabile Dimmable	
Lampadine incluse Bulbs included	Strip Led
Certificazioni Certification Marks	ERAC

TWINS

Come in un passato mai passato la materia vetro prende forma, e la luce si alterna alle ombre in un vigoroso abbraccio vorticante. Una lampada da muro dall'aspetto vigoroso ma raffinato. Il cristallo dei bracci, molto materico, è trasparente mentre le lampade sono racchiuse in tazzine di colore bianco opaco che diffonde e ammorbidisce la luce.

In a past that is ever present, the glass takes shape and light alternates with shadows to generate a vigorous, vertiginous embrace. A wall lamp with a vigorous yet refined appearance. The arms' crystal, which is very material, is transparent, while the light bulbs are enclosed in opaque white cups which diffuse and soften the light.



Modelli e misure Models and sizes

Twins
7225-02

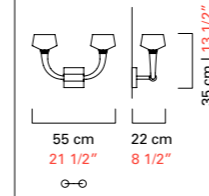

Peso Weight	4 kg 9 lb
Lampadine Bulbs	N. Tipo W max. 2 G9 40
Dimmerabile Dimmable	D
Lampadine incluse Bulbs included	G9 Led
Certificazioni Certification Marks	ETC

Colori disponibili Available colours



BC
Bianco/ Cristallo
White/ Crystal



OY
Oro Beige/ Oro
Gold Beige/ Gold

Finiture Finishings



CL
Cromo Lucido
Polished Chrome

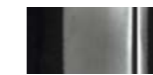

CN
Cromo Nero
Dark Chrome



OF
Ottone
Spazzolato Fine
Fine Brushed Brass

VALIANT

Un disegno anni '20, linee pulite e solo alcuni elementi decorativi. Un oggetto essenziale che non passa mai di moda particolarmente adatto ad ambienti contemporanei.

A drawing from the 20ies, clean lines and just few decorative elements. An essential object that never goes out of fashion particularly suitable for contemporary interiors.



Modelli e misure Models and sizes

	Valiant 5507-02	Valiant 5507-05
Peso Weight	2 kg 4 lb	4 kg 9 lb
Lampadine Bulbs	N. Tipo W max. 2 E14 60	N. Tipo W max. 5 E14 60
Dimmerabile Dimmable	D	D
Lampadine incluse Bulbs included		
Certificazioni Certification Marks		

Colori disponibili Available colours



CC
Cristallo
Crystal



IC
Grigio
Grey



EK
Sabbia
Sand



DK
Oliva
Olive



AK
Blu Cadetto
Cadet Blue



LQ
Bluastro
Bluastro



FK
Indaco
Indigo



CK
Pervinca
Periwinkle



VI
Viola
Violet



***OO**
Oro
Gold
*Solo OO
Only OO

Finiture Finishings



CL
Cromo Lucido
Polished Chrome



***OG**
Oro Galvanizzato
Galvanized Gold
*Solo OO
Only OO

VENEZIA 1295

L'origine di tutto, il compendio di settecento anni di tradizioni tramandate di padre in figlio, oltre le mode e il tempo che scorre: una applique ricca di storia, di dettagli e di emozioni. Caratterizzata da un elemento ricorrente, il "rostrato", un'invenzione del secolo scorso di Ercole Barovier che prende origine dalle tecniche di lavorazione artigianali dei suoi avi.

At the very heart of it all is the culmination of seven hundred years of tradition handed down from father to son through changing times and fashions: a wall sconce rich in history, detail and emotion. Featuring a recurring motif, the "rostrato," invented by Ercole Barovier almost a century ago developing techniques used by his ancestors.



Modelli e misure Models and sizes

Venezia 1295

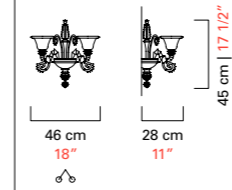
5715-02**Peso**

8 kg

Weight

18 lb

Lampadine	N.	Tipo	W max.
Bulbs	N.	Type	W max.
	2	G9	40

Dimmerabile**Dimmable****Lampadine incluse**

G9 Led

Bulbs included**Certificazioni****Certification Marks****Colori disponibili****Available colours****CC**Cristallo
Crystal**Finiture****Finishings****CL**Cromo Lucido
Polished Chrome**OG**Oro Galvanizzato
Galvanized Gold

VERMONT

Elemento caratterizzante di questa collezione di lampade da muro sono le grandi sfere in cristallo veneziano soffiato. Insieme ai bracci morbidamente ricurvi generano un'eterea ma preziosa nuvola di vetro.

The large Venetian crystal spheres are the distinctive elements of this collection. Along with the softly curved arms, they generate an ethereal but at the same time precious crystal cloud.



Modelli e misure Models and sizes

	Vermont 5550-02	Vermont 5550-05
Peso Weight	4 kg 9 lb	7 kg 16 lb
Lampadine Bulbs	N. Tipo W max. 2 E14 60 E12 60	N. Tipo W max. 5 E14 60 E12 60
Dimmerabile Dimmable	D	D
Lampadine incluse Bulbs included		
Certificazioni Certification Marks		

Colori disponibili Available colours



CC
Cristallo
Crystal



IC
Grigio
Grey



EK
Sabbia
Sand



DK
Oliva
Olive



AK
Blu Cadetto
Cadet Blue



LQ
Bluastro
Bluastro



FK
Indaco
Indigo



CK
Pervinca
Periwinkle



VI
Viola
Violet



***OO**
Oro
Gold
*Solo OG
Only OG

Finiture Finishings



CL
Cromo Lucido
Polished Chrome



***OG**
Oro Galvanizzato
Galvanized Gold
*Solo OO
Only OO

Paralumi Shades

Esterno: Cotone
External: Cotton

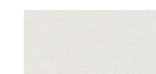
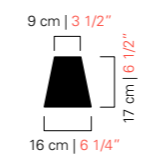

BB
Bianco
White



NN
Nero
Black



NO
Nero Interno Oro
Black Inner Gold

VERTIGO

Vertigo si ispira alle atmosfere glamour ed ammalianti degli anni '20, capaci di rievocare quel vivace fermento che investì le arti visive, il design, l'architettura e la moda dell'epoca. Attingendo a quelle vibranti tendenze estetiche, che videro New York, Mosca, Berlino e Parigi trasformarsi in capitali del lusso, del divertimento e della bella vita. Una nuova collezione affascinante e raffinata, carica di una tensione espressiva intensa e sensuale.

Vertigo takes its cue from the glamorous, seductive atmospheres of the 1920s, drawing on the lively ferment in the visual arts, design, architecture and fashion in that period. Referencing the vibrant aesthetic trends that made New York, Moscow, Berlin and Paris into worldwide capitals of luxury, entertainment and lifestyle. A new collection fascinating and refined, charged with intense and sensual expressive energy.



Modelli e misure Models and sizes

	Vertigo 5719-01	Vertigo 5719-02
Peso Weight	3 kg 7 lb	5 kg 11 lb
Lampadine Bulbs	N. Tipo W max. 1+1 G9+Led 7+1,5 N. Type W max. 7+1,5	2+1 G9+G4 7+1,5 7+1,5
Dimmerabile Dimmable	D G9	D G9
Lampadine incluse Bulbs included	G9 Led + Led	G9 Led + G4 Led
Certificazioni Certification Marks		

Colori disponibili Available colours



CC
Cristallo
Crystal



IC
Grigio
Grey



EK
Sabbia
Sand



DK
Oliva
Olive



AK
Blu Cadetto
Cadet Blue



LQ
Bluastro
Bluastro



FK
Indaco
Indigo



CK
Perwinka
Perwinkle



VI
Viola
Violet



OO
Oro
Gold

Finiture Finishings



NJ
Nickel Nero
Spazzolato
Brushed Black
Nickel



OJ
Oro Spazzolato
Brushed Gold

WEBB

La luce si moltiplica e danza nello spazio, creando pattern e prospettive inaspettate, come costellazioni in movimento. Webb gioca con la prospettiva, legge lo spazio, e con grande libertà lo anima. A definire l'infinito spettro di possibilità compositive è proprio la sua modularità. Tutto ruota intorno al modulo base in cristallo veneziano, di forma esagonale, a punta di diamante. Il tutto è impreziosito dalla tecnica della rugiada capace di conferire al cristallo una texture irregolare, diffondendo la luce morbidamente nell'ambiente. Montate su leggere strutture metalliche di sostegno, sono tre le strisce di led che percorrono il retro dell'esagono in cristallo, andandone a sottolineare la forma convessa.

Light multiplies and dances through space, creating patterns and unexpected perspectives, like constellations in motion. Webb plays with perspective, interpreting space and bringing it to life with extraordinary freedom. At the heart of its infinite compositional possibilities is its modularity. Everything revolves around a Venetian crystal module, hexagonal with a diamond-like point. The Rugiada technique gives the crystal an irregular texture, allowing light to diffuse softly into the environment. Mounted on lightweight metal structures, three LED strips run along the back of each crystal hexagon, accentuating its convex shape.

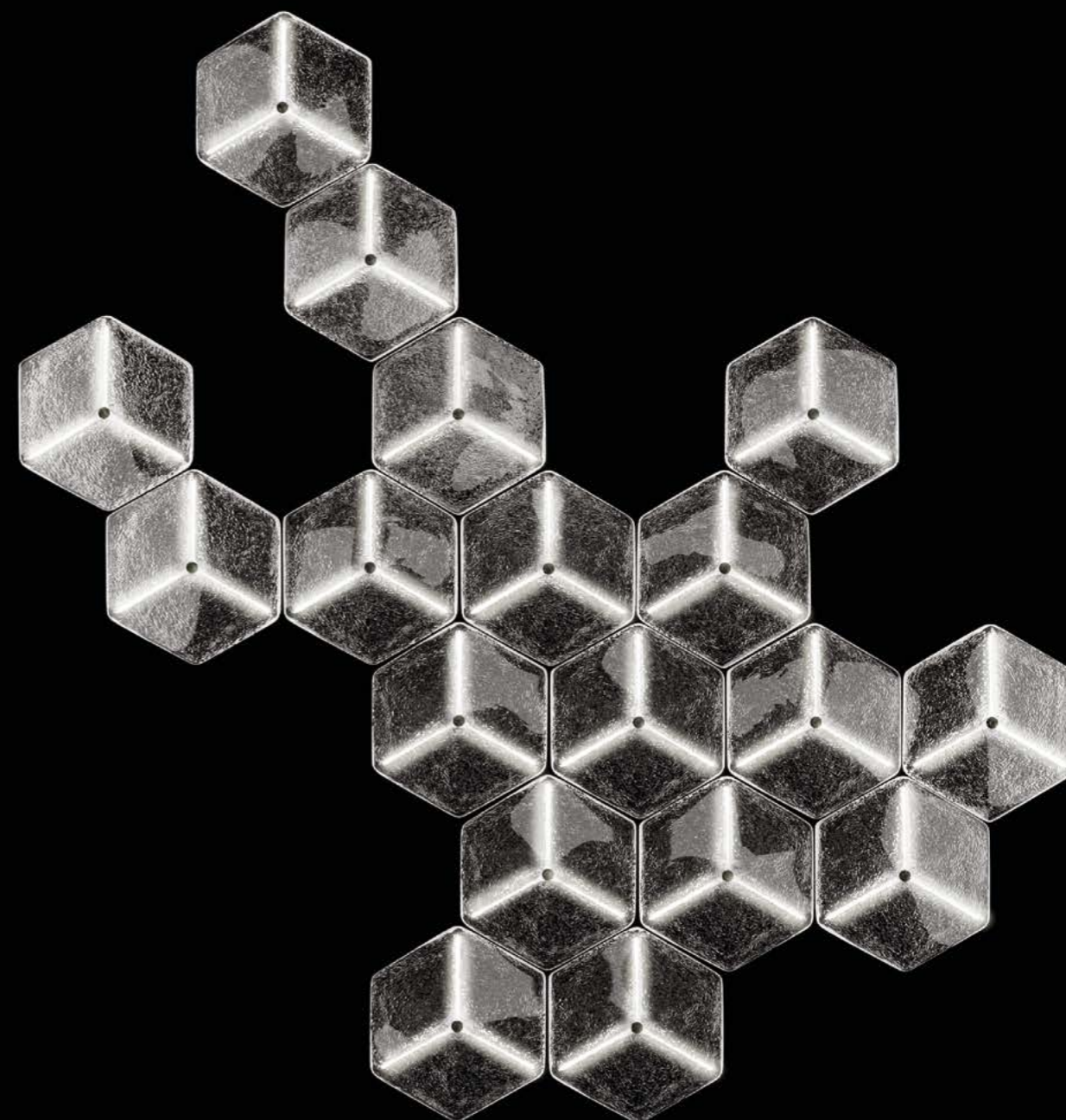
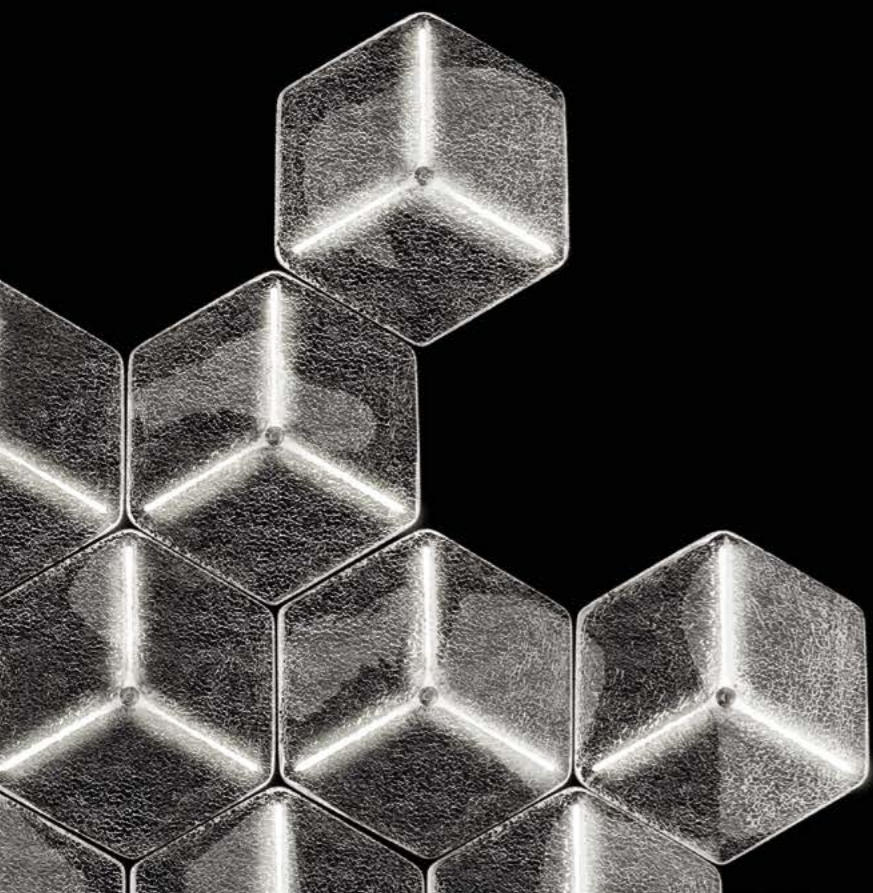

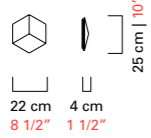
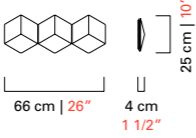
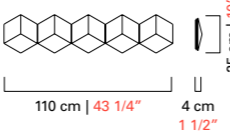
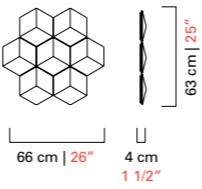
Modelli e misure Models and sizes	Webb 7540-00	Webb 7541-00	Webb 7542-00	Webb 7543-00
				
Peso Weight	2 kg 4 lb	8 kg 18 lb	12 kg 26 lb	17 kg 37 lb
Lampadine N. Tipo W max. Bulbs N. Type W max.	1 Led 3 Led 3	3 Led 3 Led 3	5 Led 3 Led 3	7 Led 3 Led 3
Dimmerabile Dimmable	D	D	D	D
Lampadine incluse Bulbs included	Led	Led	Led	Led
Certificazioni Certification Marks				

Colori disponibili
 Available colours

CR
 Cristallo Rugiada
 Crystal Rugiada

Finiture
 Finishings

CL
 Cromo Lucido
 Polished Chrome

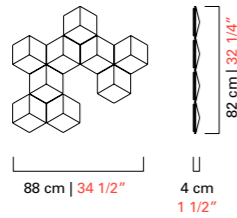
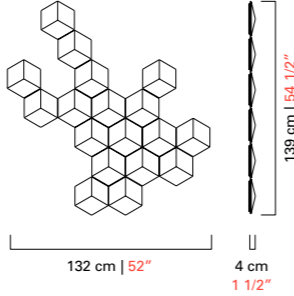
Modelli e misure Models and sizes	Webb 7544-00	Webb 7545-00
		
Peso Weight	21 kg 46 lb	40 kg 88 lb
Lampadine N. Tipo W max. Bulbs N. Type W max.	9 Led 3 Led 3	18 Led 3 Led 3
Dimmerabile Dimmable	D	D
Lampadine incluse Bulbs included	Led	Led
Certificazioni Certification Marks		

WINDSOR

Bracci sinuosi ed eleganti, che si dipanano dal fondino centrale. Le tazzine portalampana sono sempre bianco opaco con una sfumatura nella stessa tonalità dei bracci.

Sinuous, elegant arms which unfurl from the central chassis. The lamp-holder cups are always opaque white with a shade whose tonality is the same as the arms.



Modelli e misure Models and sizes

Windsor
5676-02

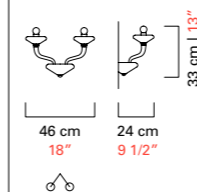

Peso Weight	3 kg 7 lb
Lampadine Bulbs	N. Tipo W max. 2 E14 60 N. Type W max. E12 60
Dimmerabile Dimmable	D
Lampadine incluse Bulbs included	
Certificazioni Certification Marks	

Colori disponibili Available colours



CC
Cristallo
Crystal



IC
Grigio
Grey



EK
Sabbia
Sand



DK
Oliva
Olive



AK
Blu Cadetto
Cadet Blue



LQ
Bluastro
Bluastro



FK
Indaco
Indigo



CK
Pervinca
Periwinkle



VI
Viola
Violet



***OO**
Oro
Gold
*Solo OG
Only OG

Finiture Finishings



CL
Cromo Lucido
Polished Chrome



***OG**
Oro Galvanizzato
Galvanized Gold
*Solo OO
Only OO



TABLE

Sofisticated presences, detentrici di scultorea lucentezza, avvolgono lo spazio di luce soffusa. Espressione di molteplici personalità, i diversi design sono modulati per ogni occasione. In comune, la capacità di connotare l'intorno dipingendo angoli caldi ed accoglienti.

Sophisticated presences, formulations of sculptural radiance, they wrap spaces in soft light. Expressing multiple personalities, the various designs are gauged to suit all occasions. They share in the ability to add character to their surroundings, producing warm, welcoming corners.

AMSTERDAM

Una lampada da tavolo che si caratterizza per il rostrato di cristallo, come il lampadario omonimo di cui è naturale complemento. Eleganza pragmatica impreziosita da un tocco unico della tradizione vetraria di Venezia.

A table lamp that is characterized by the crystal "rostrato", like the homonymous chandelier of which it is natural complement. Pragmatic elegance enriched by the unique touch of the Venetian glass-blowing tradition.



Modelli e misure Models and sizes

Amsterdam
5564-00

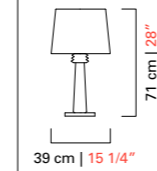

Peso Weight	6 kg 13 lb
Lampadine Bulbs	N. Tipo W max. 1 E27 100 N. Type W max. E26 60
Dimmerabile Dimmable	D
Lampadine incluse Bulbs included	
Certificazioni Certification Marks	

Colori disponibili Available colours



CC
Cristallo
Crystal



IC
Grigio
Grey



EK
Sabbia
Sand



DK
Oliva
Olive



AK
Blu Cadetto
Cadet Blue



LQ
Bluastro
Bluastro



FK
Indastro
Indigo



CK
Pervinca
Periwinkle



VI
Viola
Violet



OO
Oro
Gold

Finiture Finishings



CL
Cromo Lucido
Polished Chrome



CN
Cromo Nero
Dark Chrome



OF
Ottone
Spazzolato Fine
Fine Brushed Brass

Paralumi Shades

Esterno: Cotone
External: Cotton

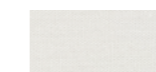
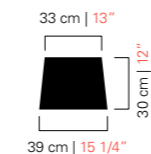

BB
Bianco
White



NN
Nero
Black



NO
Nero Interno Oro
Black Inner Gold

CAMPARINO

Camparino è una lampada da tavolo wireless elegante e raffinata che racchiude passato e presente in un unico elemento di dimensioni ridotte: da un lato interpreta la tradizione muranese utilizzando la tecnica del "rostrato", dall'altro sintetizza l'idea di modernità impiegando un sistema di alimentazione a batteria al litio ricaricabile, che la rende trasportabile ovunque, e una tecnologia che consente l'accensione, lo spegnimento e la regolazione dell'intensità luminosa con una manopola di controllo del dimmer in ottone spazzolato. Ha una base in marmo pregiato, in due varianti: Bianco Carrara e Nero Belgio.

Camparino is an elegant, sophisticated wireless table lamp that brings together past and present in a single, compact piece. On the one hand it reflects Murano glassmaking tradition, in that it uses the "rostrato" technique; on the other, it represents the ultimate in modernity: its rechargeable lithium battery allows it to be transported anywhere, while wireless technology means that it can be turned on or off and its brightness adjusted with just a movement of the brushed brass dimmer control knob.

The base is in precious marble, in two options: White Carrara and Belgian Black.



Modelli e misure Models and sizes

Camparino

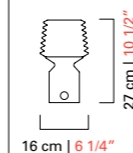
7358-00**Peso**

4 kg

Weight

9 lb

Lampadine N. Tipo W max.

1 Led 6

Bulbs N. Type W max.

6 6

Dimmerabile

D

Dimmable**Lampadine incluse**

Led

Bulbs included**Certificazioni****Certification Marks**

Colori disponibili

Available colours**CC**

Cristallo

Crystal

Finiture

Finishings**MW**

Marmo Bianco

White Marble

**MB**

Marmo Nero

Black Marble

ERCOLE

Ispirata a un'idea originale di Ercole Barovier risalente agli anni '40 del Novecento e realizzata con l'allora innovativa tecnica del "rostrato", questa lampada da tavolo è disponibile in due dimensioni differenti: la più grande è provvista di sorgente luminosa anche all'interno della base, con accensione separata.

Inspired by an original idea by Ercole Barovier in the 1940s and created using the "rostrato" technique he had just invented, this table lamp is available in different sizes: the bigger of the two includes an additional light source inside the base, controlled separately.



Modelli e misure Models and sizes

	Ercole 7356-00	Ercole 7357-00																		
Peso Weight	6 kg 13 lb	9 kg 20 lb																		
Lampadine Bulbs	<table border="1"> <thead> <tr> <th>N.</th> <th>Tipo</th> <th>W max.</th> </tr> </thead> <tbody> <tr> <td>1</td> <td>E14</td> <td>60</td> </tr> <tr> <td></td> <td>E12</td> <td>60</td> </tr> </tbody> </table>	N.	Tipo	W max.	1	E14	60		E12	60	<table border="1"> <thead> <tr> <th>N.</th> <th>Tipo</th> <th>W max.</th> </tr> </thead> <tbody> <tr> <td>1+1</td> <td>E27+G9</td> <td>60+1,5</td> </tr> <tr> <td></td> <td>E26+G9</td> <td>7+1,5</td> </tr> </tbody> </table>	N.	Tipo	W max.	1+1	E27+G9	60+1,5		E26+G9	7+1,5
N.	Tipo	W max.																		
1	E14	60																		
	E12	60																		
N.	Tipo	W max.																		
1+1	E27+G9	60+1,5																		
	E26+G9	7+1,5																		
Dimmerabile Dimmable	D	D																		
Lampadine incluse Bulbs included		E27 Led + G9 Led																		
Certificazioni Certification Marks																				

Colori disponibili Available colours



CC
Cristallo
Crystal

Finiture Finishings



CL
Cromo Lucido
Polished Chrome

EVA

Le grandi ogive sospese identificano questa lampada estremamente moderna. La leggerezza è la caratteristica principale che la rende adatta ad ogni progetto di interni.

The great hanging ogives identify this modern table lamp. Lightness is the main feature which makes it suitable for any interior design project.



Modelli e misure Models and sizes

Eva
7056-00

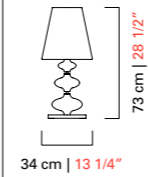

Peso Weight	7 kg 15 lb
Lampadine Bulbs	N. Tipo W max. 1 E27 100 N. Type W max. E26 60
Dimmerabile Dimmable	D
Lampadine incluse Bulbs included	
Certificazioni Certification Marks	

Colori disponibili Available colours



CC
Cristallo
Crystal



IC
Grigio
Grey



EK
Sabbia
Sand



DK
Oliva
Olive



AK
Blu Cadetto
Cadet Blue



LQ
Bluastro
Bluastro



FK
Indaco
Indigo



CK
Pervinca
Periwinkle



VI
Viola
Violet



OO
Oro
Gold

Finiture Finishings



CN
Cromo Nero
Dark Chrome



OF
Ottone
Spazzolato Fine
Fine Brushed Brass

Paralumi Shades

Esterno: Cotone
External: Cotton

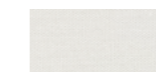
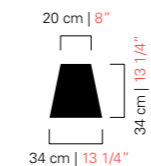

BB
Bianco
White



NN
Nero
Black



NO
Nero Interno Oro
Black Inner Gold

GALLIA

Una lampada da tavolo elegante ispirata ai canoni classici della simmetria e delle proporzioni, resa senza tempo dai colori caldi e avvolgenti: il diffusore opalino è beige con pagliuzze dorate, mentre varia il colore dell'elemento sferico detto "cipolla".

An elegant table lamp inspired by the classical canons of symmetry and proportions, rendered timeless by the warm and caressing colours: the opaline diffuser is beige, speckled with gold, while the sphere part, called "cipolla" can be of different colours.



Modelli e misure Models and sizes

Gallia
5625-00

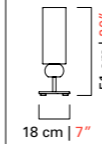

Peso Weight

6 kg
13 lb

Lampadine Bulbs

N.	Tipo	W max.		
1	E27	100		
	E26	60		

Dimmerabile Dimmable

D

Lampadine incluse Bulbs included

Certificazioni Certification Marks



Colori disponibili Available colours

A ogni colore è sempre abbinata la foglia oro.
Each colour is always combined with gold leaf.



OY
Oro Beige/ Oro
Gold Beige/ Gold



OW
Oro Beige/
Verde Oro
Gold Beige/
Green Gold



OK
Oro Beige/
Nero Oro
Gold Beige/
Black Gold

Finiture Finishings



OG
Oro Galvanizzato
Galvanized Gold



OF
Ottone
Spazzolato Fine
Fine Brushed Brass

GRACE

Philippe Nigro

Fiera ed elegante come una principessa dall'eterna bellezza, la collezione Grace è permeata da un gentile fascino classico. Eclettica la struttura, che mutua dal lampadario tradizionale muranese il sistema del diffusore: ecco che la coppetta cresce di scala e diventa un ampio calice, che accoglie ed esalta la preziosità dell'elemento luminoso al suo interno, realizzato in rostrato. Sopraffine anche le tecniche con le quali viene creato il tronco, percorso da suggestive bolle racchiuse tra due strati di vetro, cromaticamente distinti. L'effetto finale è lucente, ed è il risultato di una complessa sequenza di lavorazioni, dal ballotton sommerso fino alla specchiatura.

Proud and elegant as a princess of eternal beauty, the Grace collection is permeated by genteel classic charm. The structure is eclectic, borrowing the diffuser system from the traditional Murano chandelier: the cup grows in size and becomes a large goblet that contains and enhances the luminous element inside it, made with the rostrato technique. The methods utilized to create the trunk, crossed by evocative bubbles enclosed between two layers of glass, in separate colours, are equally sophisticated. The final effect is dazzling, the result of a complex sequence of workmanship, from dipped ballotton to mirror finishing.

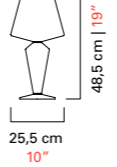
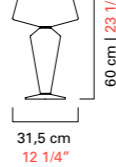

Modelli e misure Models and sizes

	Grace 7430-00	Grace 7431-00
		
Peso Weight	7 kg 15 lb	10 kg 22 lb
Lampadine N. Tipo W max. Bulbs N. Type W max.	1 G9+Led 7 G9+Led 7	1 G9+Led 7 G9+Led 7
Dimmerabile Dimmable	D G9	D G9
Lampadine incluse Bulbs included	G9 Led	G9 Led
Certificazioni Certification Marks		

Colori disponibili Available colours

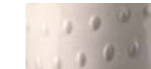

BC
Bianco/ Cristallo
White/ Crystal

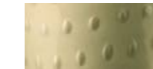

DD
Bianco/ Cristallo/
Oliva
White/ Crystal/
Olive



CZ
Bianco/ Cristallo/
Blu Cadetto
White/ Crystal/
Cadet Blue



LT
Bianco/ Cristallo/
Bluastro
White/ Crystal/
Bluastro



BT
Bianco/ Cristallo/
Viola
White/ Crystal/
Violet



CN
Bianco/ Cristallo/
Verde Antalia
White/ Crystal/
Antalia Green



AX
Bianco/ Cristallo/
Brown
White/ Crystal/
Brown

Finiture Finishings



OJ
Oro Spazzolato
Brushed Gold



CN
Cromo Nero
Dark Chrome

MARTA

Una lampada da tavolo con un fusto molto esile ed una sfera in cristallo veneziano lavorata con la tradizionale tecnica a "corteccia". La massa vetrosa ancora calda viene fatta rotolare abilmente su di uno stampo piatto a lamelle e poi, successivamente, soffiata per ottenere una superficie irregolare e tridimensionale che ricorda quella della corteccia di un albero.

A table lamp with a very slender stem bearing a Venetian crystal sphere worked with the traditional "corteccia" technique. The hot glass is skilfully turned on a flat lamellar plate and then blown to obtain an irregular three-dimensional surface, resembling the bark of a tree.



Modelli e misure Models and sizes

Marta

5576-00

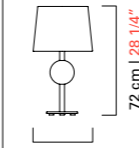

39 cm | 15 1/4"

72 cm

28 1/4"

Peso Weight

5 kg
11 lb

Lampadine Bulbs

N.	Tipo	W max.
1	E27	100
	E26	100

Dimmerabile Dimmable

D

Lampadine incluse Bulbs included

Certificazioni Certification Marks



Colori disponibili Available colours



CC
Cristallo
Crystal



IC
Grigio
Grey



EK
Sabbia
Sand



DK
Oliva
Olive



AK
Blu Cadetto
Cadet Blue



LQ
Bluastro
Bluastro



FK
Indaco
Indigo



CK
Pervinca
Periwinkle



VI
Viola
Violet



OO
Oro
Gold

Finiture Finishings



CL
Cromo Lucido
Polished Chrome



CN
Cromo Nero
Dark Chrome



OF
Ottone
Spazzolato Fine
Fine Brushed Brass

Paralumi Shades

Esterno: Cotone
External: Cotton

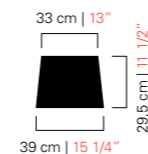

33 cm | 13"

39 cm | 15 1/4"

29,5 cm

11 1/2"

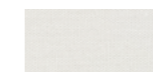

BB
Bianco
White



NN
Nero
Black



NO
Nero Interno Oro
Black Inner Gold



MEDINA

Una collezione formosa, con dimensioni generose dalle linee quasi boteriane. Il collare metallico ed i paralumi fuori scala caratterizzano l'intera linea.

A shapely collection with generous dimensions whose design recalls somehow Botero's drawings. The metal neck and the oversize shades are distinctive of the entire line.

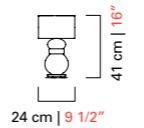
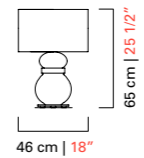

Modelli e misure Models and sizes

	Medina 5685-00	Medina 5686-00
		
Peso Weight	4 kg 9 lb	7 kg 15 lb
Lampadine Bulbs	N. Tipo W max. 1 E14 60 E12 60	N. Tipo W max. 1 E27 100 E26 100
Dimmerabile Dimmable	D	D
Lampadine incluse Bulbs included		
Certificazioni Certification Marks		

Colori disponibili Available colours



CC
Cristallo
Crystal



IC
Grigio
Grey



EK
Sabbia
Sand



DK
Oliva
Olive



AK
Blu Cadetto
Cadet Blue



LQ
Bluastro
Bluastro



FK
Indaco
Indigo



CK
Pervinca
Periwinkle



VI
Viola
Violet



OO
Oro
Gold

Finiture Finishings



CL
Cromo Lucido
Polished Chrome



CN
Cromo Nero
Dark Chrome



OF
Ottone
Spazzolato Fine
Fine Brushed Brass

Paralumi Shades

Esterno: Cotone
External: Cotton



BB
Bianco
White



NN
Nero
Black

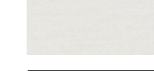

NO
Nero Interno Oro
Black Inner Gold

OPÉRA

Philippe Nigro

Opéra è una collezione di lampade ispirata all'Opéra Garnier, in cui l'elemento principale è la lavorazione del rostrato. La forma cilindrica va ad enfatizzare il motivo ornamentale, moltiplicando gli angoli di incidenza dei raggi luminosi e creando un fitto involuppo di punte tridimensionali. Alle creazioni in Cristallo Veneziano sono abbinati elementi metallici dalla silhouette molto affine, che circondano e sostengono i corpi luminosi. Il modello da tavolo presenta un'estetica ancora più avvolgente, capace di creare, anche da spenta, un'atmosfera calda e preziosa.

Opéra is a collection of lamps inspired by the Opéra Garnier, where the main feature is the rostrato. The cylindrical form underscores the ornamental motif, multiplying the angles of impact of beams of light and creating a dense wrapping of three-dimensional points. The creations in Venetian Crystal are joined by metal parts with a very similar silhouette, which surround and support the luminous volumes: completely different textures, sharing a specific inspiration in their shapes and substance. The table model has an even more enveloping look, and is able to create a warm, precious atmosphere even when the lamp is off.



Modelli e misure Models and sizes

Opéra

7391-00

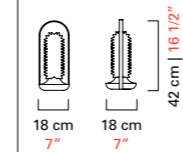

Peso

Weight

8 kg
18 lb

Lampadine

Bulbs

N.	Tipo	W max.
1	Strip Led	10

Strip Led 10

Dimmerabile

Dimmable

D

Not dimmable for the USA version

Lampadine incluse

Bulbs included

Strip Led

Certificazioni

Certification Marks



Colori disponibili

Available colours



CC

Cristallo
Crystal

Finiture

Finishings

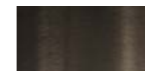

NJ

Nickel Nero
Spazzolato
Brushed Black
Nickel



OJ

Oro Spazzolato
Brushed Gold

PADMA

Collezione disegnata per esprimere armonia, sintesi tra le parti, sinergia tra contrasti. L'ampolla esterna presenta un design molto pulito, ottenuto con un'unica soffiata e una graduale sfumatura di colore, risultato di un sapiente gesto artigianale. Gli altri elementi, invece, finemente lavorati con la tipica tecnica muranese delle costolature, hanno delle forme complesse e sofisticate.

This collection is designed to express harmony, a synthesis of parts, a synergy of contrasts. The external ampoule has a very clean design, made in a single blowing, and a gradually shaded colour, produced by the skillful gesture of the artisan. The other parts, finely crafted with the typical Murano ribbing technique, have complex, sophisticated forms.



Modelli e misure Models and sizes

	Padma 7378-00	Padma 7380-00	Padma 7382-00
Peso Weight	8 kg 15 lb	8 kg 15 lb	8 kg 15 lb
Lampadine N. Tipo W max. Bulbs N. Type W max.	1 Led 10 1 Led 10	1 Led 10 1 Led 10	1 Led 10 1 Led 10
Dimmerabile Dimmable	D	D	D
Lampadine incluse Bulbs included	Led	Led	Led
Certificazioni Cerification Marks	EAC	EAC	EAC

Colori disponibili Available colours

Diffusore Bianco sfumato o
Diffusore Grigio Sfumato
*Shaded White Diffuser or
Shaded Grey Diffuser*

Il colore si riferisce solo al finalino
*The colour refers only to the
final element*



BB
Bianco/ Bianco
White/ White



BC
Bianco/ Cristallo
White/ Crystal



IN
Bianco/ Grigio
White/ Grey



EW
Bianco/ Sabbia
White/ Sand



BP
Bianco/ Oliva
White/ Olive



BU
Bianco/ Bluastro
White/ Bluastro



FB
Bianco/ Indaco
White/ Indigo



CP
Bianco/ Periwinkle
White/ Periwinkle



BO
Bianco/ Oro
White/ Gold



BN
Bianco/ Nero
White/ Black

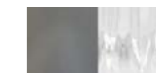

IT
Grigio/ Cristallo
Grey/ Crystal

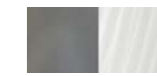

YG
Grigio/ Bianco
Grey/ White



IC
Grigio/ Grigio
Grey/ Grey

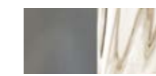

FS
Grigio/ Sabbia
Grey/ Sand

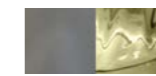

FR
Grigio/ Oliva
Grey/ Olive

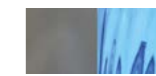

DJ
Grigio/ Bluastro
Grey/ Bluastro

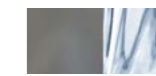

FT
Grigio/ Indaco
Grey/ Indigo

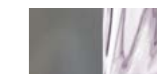

FQ
Grigio/ Periwinkle
Grey/ Periwinkle



GG
Grigio/ Oro
Grey/ Gold



EC
Grigio/ Nero
Grey/ Black

Finiture Finishings



NJ
Nickel nero
spazzolato
*Brushed Black
Nickel*



OJ
Oro Spazzolato
Brushed Gold

PERSEUS

Marcel Wanders

Una scultura luminosa da tavolo, un'emozione di luce, agli antipodi del classico. Composta da un gran numero di elementi in cristallo veneziano che rappresentano un mix delle tecniche vetrarie reinterpretate, accostate e mescolate in modo sovversivo rispetto ai canoni della classicità.

An illuminated sculpture, a lighting emotion, a world away from the classic style. It is composed of a large number of Venetian crystal elements that represent a mix of the glassmaking techniques reinterpreted, paired, and mixed in a subversive way with respect to the canons of classicism.



Modelli e misure Models and sizes

Perseus
7314-00

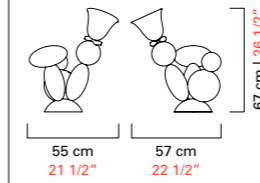

Peso Weight

10 kg
22 lb

Lampadine Bulbs

N.	Tipo	W max.
3	G4	7

Dimmerabile Dimmable

Lampadine incluse Bulbs included

G4 Led

Certificazioni Certification Marks

ERAC

Colori disponibili Available colours



WZ

Cristallo/
Cedro liquido/
Acquamarine/ Grigio/
Bianco
Crystal/
Liquid Citron/
Aquamarine/
Grey/ White



WP

Cristallo/ Grigio/
Brown/ Cognac/
Bianco
Crystal/ Grey/
Brown/ Cognac/
White

Finiture Finishings



CL

Cromo Lucido
Polished Chrome

PIGALLE

Tradizione ed innovazione si fondono in questa collezione ispirata alla Belle Époque. Si caratterizza per eleganza e linee sinuose senza risultare eccessiva ed ostentata. Eloquente per raffinatezza e grazia alterna linee semplici, dettagli curvi e lavorazioni tradizionali.

Tradition and innovation blend in this collection inspired by the Belle Époque. It stands out for its elegant, sinuous lines, without ever seeming excessive or ostentatious. With its eloquent refinement and grace, it mixes simple lines, curved details and traditional workmanship.



Modelli e misure Models and sizes

	Pigalle 5677-00	Pigalle 5678-00
Peso Weight	12 kg 26 lb	7 kg 15 lb
Lampadine Bulbs	N. Tipo W max. 3 E14 60	N. Tipo W max. 3 E14 60
Dimmerabile Dimmable	D	D
Lampadine incluse Bulbs included		
Certificazioni Certification Marks		

Colori disponibili Available colours



BC
Bianco/ Cristallo
White/ Crystal



OY
Oro Beige/ Oro
Gold Beige/ Gold

Finiture Finishings



CL
Cromo Lucido
Polished Chrome



CN
Cromo Nero
Dark Chrome



OJ
Oro Spazzolato
Brushed Gold

Paralumi Shades

Esterno: Cotone
External: Cotton

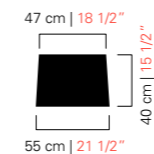

BB
Bianco
White

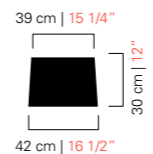

NN
Nero
Black



NO
Nero Interno Oro
Black Inner Gold

RAN

Trasparenza e leggerezza. Grazie alle ogive soffiate in serie questa piccola lampada da tavolo acquisisce una straordinaria lievità e delicatezza.

Transparency and lightness. Thanks to the mouth blown ogives aligned in series this tiny table lamp appears extremely slight and delicate.



Modelli e misure Models and sizes

	Ran 7180-00	Ran 7181-00	Ran 7182-00
Peso Weight	4 kg 9 lb	7 kg 15 lb	9 kg 20 lb
Lampadine Bulbs	N. Tipo W max. 1 E14 60	N. Tipo W max. 1 E27 100	N. Tipo W max. 1 E27 100
Dimmerabile Dimmable	D	D	D
Lampadine incluse Bulbs included			
Certificazioni Certification Marks			

Colori disponibili Available colours



CC
Cristallo
Crystal



IC
Grigio
Grey



EK
Sabbia
Sand



DK
Oliva
Olive



AK
Blu Cadetto
Cadet Blue



LQ
Bluastro
Bluastro



FK
Indaco
Indigo



CK
Pervinca
Periwinkle



VI
Viola
Violet



OO
Oro
Gold

Finiture Finishings



CL
Cromo Lucido
Polished Chrome



CN
Cromo Nero
Dark Chrome



OF
Ottone
Spazzolato Fine
Fine Brushed Brass

Paralumi Shades

Esterno: Cotone
External: Cotton

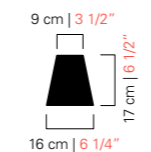

9 cm | 3 1/2"
17 cm | 6 1/2"
16 cm | 6 1/4"

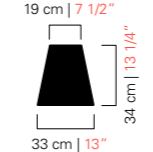

19 cm | 7 1/2"
34 cm | 13 1/4"
33 cm | 13"

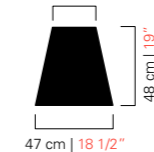

27 cm | 10 1/2"
48 cm | 19"
47 cm | 18 1/2"

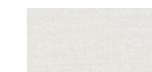

BB
Bianco
White



NN
Nero
Black

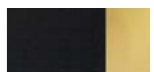

NO
Nero Interno Oro
Black Inner Gold

RIVE GAUCHE

Giorgia Brusemini

Una lampada dal sapore anni '50 che racconta la poesia e l'incanto di un prodotto interamente realizzato a mano in cristallo veneziano. Elemento distintivo è la sfera realizzata con la tecnica dell'oro sommerso.

A table lamp that recalls the 50ies style that tells the poetry and enchantment of a product made entirely by hand in Venetian crystal, featuring a distinctive sphere made with the "oro sommerso" technique.



Modelli e misure Models and sizes

Rive Gauche

7068-00

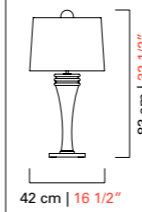

Peso
Weight

8 kg
18 lb

Lampadine N. Tipo W max.
Bulbs N. Type W max.

3 E14 60
E12 60

Dimmerabile
Dimmable

D

Lampadine incluse
Bulbs included

Certificazioni
Certification Marks



Colori disponibili Available colours



CC
Cristallo
Crystal



IC
Grigio
Grey



EK
Sabbia
Sand



DK
Oliva
Olive



AK
Blu Cadetto
Cadet Blue



LQ
Bluastro
Bluastro



FK
Indaco
Indigo



CK
Perivinka
Periwinkle



VI
Viola
Violet



OO
Oro
Gold

Finiture Finishings



CL
Cromo Lucido
Polished Chrome



OG
Oro Galvanizzato
Galvanized Gold

Paralumi Shades

Esterno: Cotone
External: Cotton

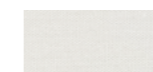
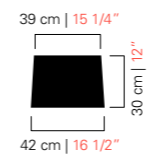

BB
Bianco
White



NN
Nero
Black

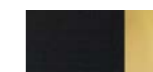

NO
Nero Interno Oro
Black Inner Gold

ROTTERDAM

Fusto ogivale e rocchetti di cristallo creati artigianalmente utilizzando un brevetto Barovier&Toso: il "rostrato". Oggetto prezioso, di straordinaria eleganza e raffinatezza capace di soddisfare un cliente esigente e sofisticato.

An oval trunk, crystal spoils created by hand using a Barovier&Toso patent: "rostrato". A precious object of extraordinary elegance and refinement, capable of satisfying the most demanding and sophisticated customers.



Modelli e misure Models and sizes

Rotterdam
5565-00

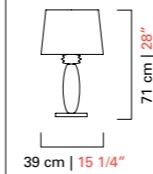

Peso Weight	6 kg 13 lb
Lampadine Bulbs	N. Tipo W max. 1 E27 100 N. Type W max. E26 60
Dimmerabile Dimmable	D
Lampadine incluse Bulbs included	
Certificazioni Certification Marks	

Colori disponibili Available colours



CC
Cristallo
Crystal



IC
Grigio
Grey



EK
Sabbia
Sand



DK
Oliva
Olive



AK
Blu Cadetto
Cadet Blue



LQ
Bluastro
Bluastro



FK
Indaco
Indigo



CK
Pervinca
Periwinkle



VI
Viola
Violet



OO
Oro
Gold

Finiture Finishings



CL
Cromo Lucido
Polished Chrome



CN
Cromo Nero
Dark Chrome



OF
Ottone
Spazzolato Fine
Fine Brushed Brass

Paralumi Shades

Esterno: Cotone
External: Cotton



BB
Bianco
White



NN
Nero
Black



NO
Nero Interno Oro
Black Inner Gold

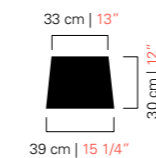

SAINT GERMAIN

Giorgia Brusemini

Una lampada dal sapore anni '50 che racconta la poesia e l'incanto di un prodotto interamente realizzato a mano in cristallo veneziano. Elemento distintivo è la sfera realizzata con la tecnica dell'oro sommerso.

A table lamp that recalls the 50ies style that tells the poetry and enchantment of a product made entirely by hand in Venetian crystal, featuring a distinctive sphere made with the "oro sommerso" technique.



Modelli e misure Models and sizes

Saint Germain
7060-00

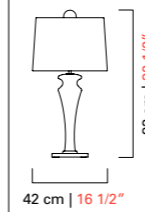

Peso Weight	8 kg 18 lb
Lampadine Bulbs	N. Tipo W max. 3 E14 60 N. Type W max. E12 60
Dimmerabile Dimmable	D
Lampadine incluse Bulbs included	
Certificazioni Certification Marks	

Colori disponibili Available colours



CC
Cristallo
Crystal



IC
Grigio
Grey



EK
Sabbia
Sand



DK
Oliva
Olive



AK
Blu Cadetto
Cadet Blue



LQ
Bluastro
Bluastro



FK
Indaco
Indigo



CK
Pervinca
Periwinkle



VI
Viola
Violet



OO
Oro
Gold

Finiture Finishings



CL
Cromo Lucido
Polished Chrome



OG
Oro Galvanizzato
Galvanized Gold

Paralumi Shades

Esterno: Cotone
External: Cotton

39 cm | 15 1/4"

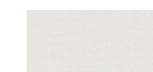
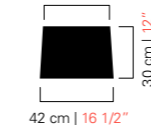

BB
Bianco
White



NN
Nero
Black



NO
Nero Interno Oro
Black Inner Gold

SAMURAI

Angelo Barovier

Angelo Barovier, nel 1966, progettava una lampada con costolature che successivamente è stata ripresa, ingigantita, messa sotto sopra e moltiplicata, fino ad ottenere un oggetto dalle dimensioni generose. Il disegno è caratterizzato da linee piramidali che fanno pensare ad un Samurai in posizione di riposo. Il cristallo veneziano con cui è realizzata è molto massiccio e la sua esecuzione richiede la mano e la forza di un esperto maestro vetraio.

Angelo Barovier had an idea for a ribbed lamp in 1966. Then his design was revisited, but this time inverted, repeated and created on a giant scale. Its pyramid shape recalls of a Samurai at rest. The Venetian crystal used for this piece is extremely massive, and working it requires the skill and strength of an experienced master glassmaker.



Modelli e misure Models and sizes

	Samurai 7052-00	Samurai 7082-00	Samurai 7081-00
Peso Weight	12 kg 26 lb	9 kg 20 lb	7 kg 15 lb
Lampadine N. Tipo W max. Bulbs N. Type W max.	3 E14 60 E12 60	3 E14 40 E12 40	1 E14 40 E12 40
Dimmerabile Dimmable	D	D	D
Lampadine incluse Bulbs included			
Certificazioni Certification Marks			

Colori disponibili Available colours



CC
Cristallo
Crystal



IC
Grigio
Grey



EK
Sabbia
Sand



DK
Oliva
Olive



AK
Blu Cadetto
Cadet Blue



LQ
Bluastro
Bluastro



FK
Indaco
Indigo



CK
Pervinca
Periwinkle



VI
Viola
Violet



OO
Oro
Gold

Finiture Finishings



CN
Cromo Nero
Dark Chrome



OF
Ottone
Spazzolato Fine
Fine Brushed Brass

Paralumi Shades

Esterno: Cotone
External: Cotton



BB
Bianco
White



NN
Nero
Black



NO
Nero Interno Oro
Black Inner Gold

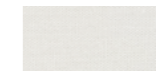

BB
Bianco
White



NN
Nero
Black



NO
Nero Interno Oro
Black Inner Gold

SARA

Una lampada da tavolo dalla forma generosa e curvilinea impreziosita da una fascia realizzata in foglia d'oro 24K applicata esternamente.

Sinuous and curvy lines for this table lamp whose precious detail is the 24K gold leaf strip applied on the surface.



Modelli e misure Models and sizes

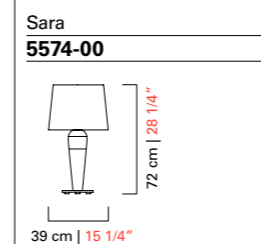

Peso Weight	5 kg 11 lb
Lampadine Bulbs	N. Tipo W max. 1 E27 100 N. Type W max. E26 100
Dimmerabile Dimmable	D
Lampadine incluse Bulbs included	
Certificazioni Certification Marks	

Colori disponibili Available colours



Finiture Finishings

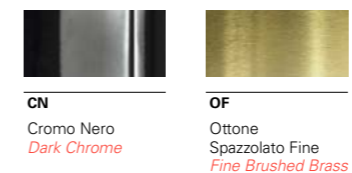

Paralumi Shades

Esterno: Cotone
External: Cotton

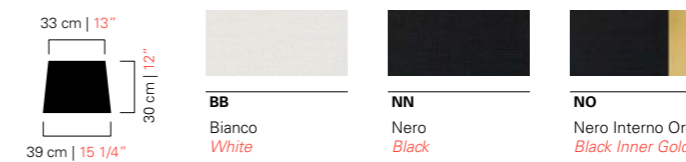

SIDERIS

Toccare il cielo con un dito: Galileo Galilei secoli fa ha osato puntare il cannocchiale verso l'alto per misurare l'immensità del cielo, facendo scoperte rivoluzionarie. La lampada da lettura Sideris è un omaggio al coraggio di Galileo. La base in porcellana, disponibile in oro o platino, sostiene una sfera di cristallo veneziano soffiato a bocca preziosamente realizzato con un doppio strato di foglia oro o di foglia argento. Dall'incontro di questi elementi unici nasce una rivoluzione luminosa, un oggetto funzionale e decorativo che trasforma un gesto senza tempo in una lampada da tavolo.

Touch the sky with a finger: Galileo Galilei centuries ago dared to point the telescope upwards to measure the immensity of the sky, making revolutionary discoveries. The Sideris reading lamp is a tribute to Galileo's courage. The porcelain base, available in gold or platinum, supports a hand-blown Venetian crystal sphere precisely made with a double layer of gold or silver leaf. From the meeting of these unique elements a luminous revolution is born, a functional and decorative object that transforms a timeless gesture into a table lamp.



Modelli e misure Models and sizes

Sideris
7405-00

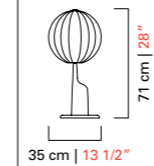

Peso Weight

8 kg
18 lb

Lampadine Bulbs

N.	Tipo	W max.
1	Strip Led	8,5

Dimmerabile Dimmable

D

Lampadine incluse Bulbs included

Strip Led

Certificazioni Certification Marks



Colori disponibili Available colours



AT

Argento
Silver



OO

Oro
Gold

Finiture Finishings



*CL

Cromo Lucido
Polished Chrome

*Solo AT
Only AT



*OG

Oro Galvanizzato
Galvanized Gold

*Solo OO
Only OO

Porcellana Porcelain



*Bianco /
Cromo Lucido
White /
Polished Chrome

*Solo AT
Only AT



*Bianco /
Oro Galvanizzato
White /
Galvanized Gold

*Solo OO
Only OO

TRINITAS

Trinitas è basata sulla concezione rinascimentale del tre che diventa uno, fondamento della bellezza universale. In Trinitas ogni componente dell'oggetto si fonde insieme per creare un'armonia estetica. La lampada Trinitas è portatile, ricaricabile e si adatta con semplicità ed eleganza a qualsiasi ambiente, risultando ideale anche per completare una mise en place. Tre elementi di cristallo veneziano soffiati a bocca si uniscono su un vassoio di porcellana sostenuto da un arco di metallo semi-opaco placcato oro. Le lavorazioni ballotòn, rigadin e rigamenà presenti sui cristalli omaggiano la tradizione muranese. Disponibile in tre colorazioni con intensità di luce regolabile, Trinitas è interamente lavorata a mano, rendendo ogni pezzo unico e irripetibile.

Trinitas is based on the Renaissance concept of three becoming one, the foundation of universal beauty. In Trinitas each component of the object blends together to create an aesthetic harmony. The Trinitas lamp is portable, rechargeable and adapts with simplicity and elegance to any environment, also making it ideal for completing a mise en place. Three mouth-blown Venetian crystal elements come together on a porcelain tray supported by a gold-plated semi-opaque metal arch. The ballotòn, rigadin and rigamenà textures present on the crystals pay homage to the Murano tradition. Available in three colors with adjustable light intensity, Trinitas is entirely handmade, making each piece unique and unrepeatable.



Modelli e misure Models and sizes

Trinitas
7404-00

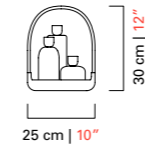

Peso Weight	5 kg 11 lb
Lampadine Bulbs	N. Tipo W max. 3 Led 0,83+1,66+2,49 N. Type W max. 0.83+1.66+2.49
Dimmerabile Dimmable	D
Lampadine incluse Bulbs included	Led
Certificazioni Certification Marks	ERAC c UL us

Colori disponibili Available colours



XF

Fumé / Grigio /
Cristallo
*Smoke / Grey /
Crystal*



XL

Indaco / Grigio /
Oliva
*Indigo / Grey /
Olive*



XR

Ametista / Grigio /
Pervinca
*Amethyst / Grey /
Periwinkle*

Finiture Finishings



OG

Oro Galvanizzato
Galvanized Gold

Porcellana Porcelain



Bianco

White
*Solo XF
Only XF



Azzurro

Light Blue
*Solo XL
Only XL



Rosa

Pink
*Solo XR
Only XR

TWINS

Come in un passato mai passato la materia vetro prende forma, e la luce si alterna alle ombre in un vigoroso abbraccio vorticante. Una lampada da tavolo dall'aspetto vigoroso ma raffinato.

In a past that is ever present, the glass takes shape and light alternates with shadows to generate a vigorous, vertiginous embrace. A table lamp with a vigorous yet refined appearance.



Modelli e misure Models and sizes

Twins

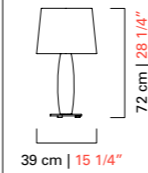
7224-00

Peso Weight

5 kg
11 lb

Lampadine Bulbs

N.	Tipo	W max.
1	E27	100
	E26	60

Dimmerabile Dimmable

D

Lampadine incluse Bulbs included

Certificazioni Certification Marks



Colori disponibili Available colours



CC
Cristallo
Crystal



OO
Oro
Gold

Finiture Finishings



CL
Cromo Lucido
Polished Chrome



CN
Cromo Nero
Dark Chrome



OF
Ottone
Spazzolato Fine
Fine Brushed Brass

Paralumi Shades

Esterno: Cotone
External: Cotton

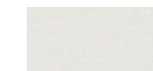
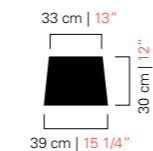

BB
Bianco
White



NN
Nero
Black



NO
Nero Interno Oro
Black Inner Gold

VERONESE

Umberto Riva

Un vaso di cristallo attraversato da un raggio di luce nel famoso quadro di Paolo Veronese che rappresenta l'Annunciazione. A questo si ispirano le linee purissime di questo oggetto riletto in chiave moderna e di grande eleganza. Con la sua luce diffusa e avvolgente questa lampada si inserisce indifferentemente sia in ambienti classici che in arredamenti moderni e contemporanei rendendoli unici ed esclusivi.

A crystal vase crossed by a beam of light, in the famous painting by Paolo Veronese depicting the Annunciation. This is the image behind the pure lines of an object of consummate elegance, reinterpreted in modern terms. With its diffused, enveloping light the lamp fits perfectly into classic and modern decors, bringing them unique, exclusive character.



Modelli e misure Models and sizes

Veronese
6536-00

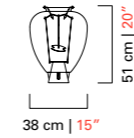

Peso Weight

9 kg
20 lb

Lampadine Bulbs

N.	Tipo	W max.
1	GU10	20

N.	Type	W max.
1	GU10	20

Dimmerabile Dimmable

D

Lampadine incluse Bulbs included

GU10 Led

Certificazioni Certification Marks

ETC

Colori disponibili Available colours



CC
Cristallo
Crystal



VV
Verdino
Light Green



AA
Ambra
Amber

Finiture Finishings



CN
Cromo Nero
Dark Chrome



FLOOR

Sostengono punti di luce, proiettando impalpabili nuvole luminose. Sono slanciate e lineari oppure affusolate ed adorne di dettagli lungo il fusto. Si inseriscono in modo dinamico nell'ambiente, valorizzando l'arredo e caratterizzando l'atmosfera.

Supporting spots of light they project impalpable clouds of light. They are slender and linear, or tapered and adorned with refined details along the stem. For dynamic insertion in any context, they enhance the decor and define the atmosphere.

AMSTERDAM

Il fascino discreto della luce soffusa, calda e avvolgente. Una lampada che ha il potere di trasformare qualsiasi ambiente in uno spazio accogliente e piacevole giocando con l'alternanza fra volumi opachi e volumi trasparenti, un dialogo fra lavorazioni diverse che esaltano la fattura del prodotto. Elegante e preziosa è caratterizzata da rocchetti in rostrato.

The discreet charm of soft, warm, enveloping light. A lamp that has the power to transform any room into a welcoming, appealing space, alternating opaque and transparent volumes, in a dialogue of different craftings that bring out the fine workmanship of the product. Elegant and precious it is characterized by "rostrato" details.



Modelli e misure Models and sizes

Amsterdam
7352-00

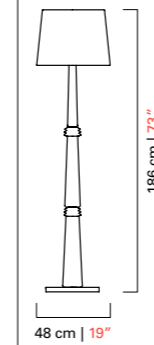

Peso Weight	18 kg 40 lb
Lampadine Bulbs	N. Tipo W max. 1 E27 100 N. Type W max. E26 100
Dimmerabile Dimmable	D
Lampadine incluse Bulbs included	
Certificazioni Certification Marks	UL ENEC UL US

Colori disponibili Available colours



CC
Cristallo
Crystal



IC
Grigio
Grey



EK
Sabbia
Sand



DK
Oliva
Olive



AK
Blu Cadetto
Cadet Blue



LQ
Bluastro
Bluastro



FK
Indaco
Indigo



CK
Pervinca
Periwinkle



VI
Viola
Violet



OO
Oro
Gold

Finiture Finishings



CL
Cromo Lucido
Polished Chrome



CN
Cromo Nero
Dark Chrome



OF
Ottone
Spazzolato Fine
Fine Brushed Brass

Paralumi Shades

Esterno: Cotone
External: Cotton



BB
Bianco
White

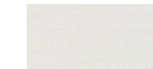

NN
Nero
Black

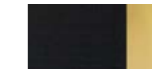

NO
Nero Interno Oro
Black Inner Gold

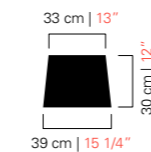

CONTERIE

La lampada da terra Conterie trae ispirazione dai gioielli in porcellana dell'archivio storico della Manifattura Ginori 1735. La sua struttura è composta da perle preziose di porcellana lavorata a mano e cristallo veneziano soffiato a bocca con differenti le texture, frutto di tre diverse lavorazioni artigianali, ballotòn, rigadin e rigamenà. La luce si diffonde dolcemente dal cono di vetro di Murano, che riprende la forma simmetrica della base in porcellana. Come una collana che illumina il viso di chi la indossa, Conterie è in grado di illuminare la casa con la sua luce delicata.

The Conterie floor lamp draws inspiration from the porcelain jewels of the Ginori 1735 Manifattura historical archive. Its structure is composed of precious hand-crafted porcelain beads and mouth-blown Venetian crystal with different textures, the result of three different craftsmanship, ballotòn, rigadin and rigamenà. The light diffuses softly from the Murano glass cone, which takes up the symmetrical shape of the porcelain base. Like a necklace that illuminates the wearer's face, Conterie is able to illuminate the home with its delicate light.



Modelli e misure Models and sizes

Conterie
7406-00

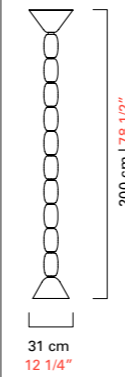

Peso Weight	13 kg 28,6 lb									
Lampadine Bulbs	<table border="1"> <thead> <tr> <th>N.</th> <th>Tipo</th> <th>W max.</th> </tr> </thead> <tbody> <tr> <td>1</td> <td>E27</td> <td>100</td> </tr> <tr> <td></td> <td>E26</td> <td>100</td> </tr> </tbody> </table>	N.	Tipo	W max.	1	E27	100		E26	100
N.	Tipo	W max.								
1	E27	100								
	E26	100								
Dimmerabile Dimmable	D									
Lampadine incluse Bulbs included										
Certificazioni Certification Marks										

Colori disponibili Available colours



AH
Bianco/ Giallo
White/Yellow

Finiture Finishings



OG
Oro Galvanizzato
Galvanized Gold

ERCOLE

Ispirata a un'idea originale di Ercole Barovier risalente agli anni '40 del Novecento e realizzata con l'allora innovativa tecnica del "rostrato", Ercole è una lampada da terra caratterizzata da un ricco effetto di luce che le conferisce preziosità e ricchezza.

Inspired by an original idea by Ercole Barovier in the 1940s and created using the "rostrato" technique he had just invented, the Ercole floor lamp is distinguished by a rich play of light that creates a sense of luxury and richness.

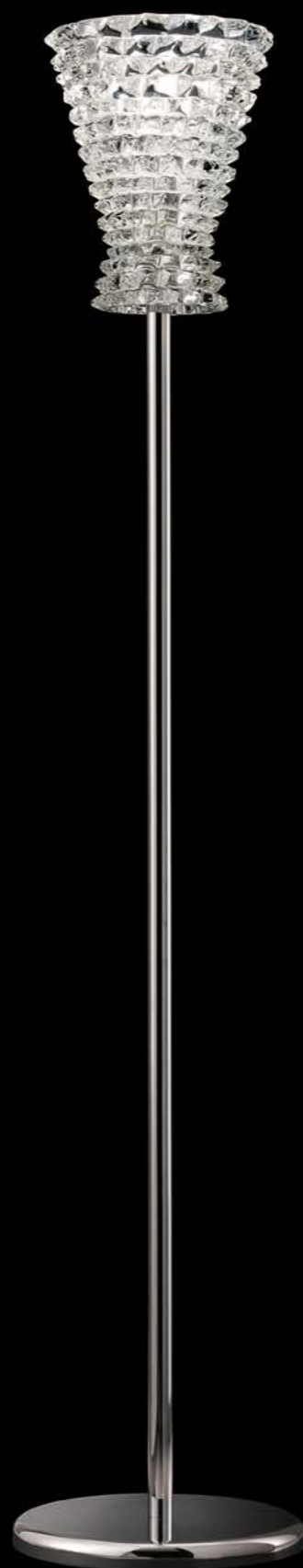

Modelli e misure Models and sizes

Ercole
7355-00

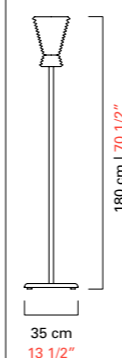

Peso Weight	27 kg 82 lb									
Lampadine Bulbs	<table border="1"> <thead> <tr> <th>N.</th> <th>Tipo</th> <th>W max.</th> </tr> </thead> <tbody> <tr> <td>1</td> <td>E27</td> <td>100</td> </tr> <tr> <td></td> <td>E26</td> <td>100</td> </tr> </tbody> </table>	N.	Tipo	W max.	1	E27	100		E26	100
N.	Tipo	W max.								
1	E27	100								
	E26	100								
Dimmerabile Dimmable	D									
Lampadine incluse Bulbs included										
Certificazioni Certification Marks										

Colori disponibili Available colours



CC
Cristallo
Crystal

Finiture Finishings



CL
Cromo Lucido
Polished Chrome

EVA

Le grandi ogive sospese identificano questa lampada estremamente moderna. La leggerezza è la caratteristica principale che la rende adatta ad ogni progetto di interni.

The great hanging ogives identify this modern floor lamp. Lightness is the main feature which makes it suitable for any interior design project.



Modelli e misure Models and sizes

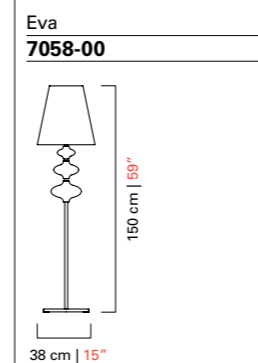

Peso Weight	10 kg 22 lb
Lampadine Bulbs	N. Tipo W max. 1 E27 100 N. Type W max. E26 60
Dimmerabile Dimmable	D
Lampadine incluse Bulbs included	
Certificazioni Certification Marks	

Colori disponibili Available colours



CC
Cristallo
Crystal



IC
Grigio
Grey



EK
Sabbia
Sand



DK
Oliva
Olive



AK
Blu Cadetto
Cadet Blue



LQ
Bluastro
Bluastro



FK
Indaco
Indigo



CK
Pervinca
Periwinkle



VI
Viola
Violet



OO
Oro
Gold

Finiture Finishings



CN
Cromo Nero
Dark Chrome



OF
Ottone
Spazzolato Fine
Fine Brushed Brass

Paralumi Shades

Esterno: Cotone
External: Cotton

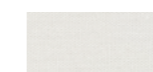
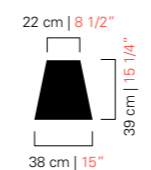

BB
Bianco
White



NN
Nero
Black



NO
Nero Interno Oro
Black Inner Gold

GALLIA

Una lampada da terra elegante ispirata ai canoni classici della simmetria e delle proporzioni, resa senza tempo dai colori caldi e avvolgenti: il diffusore opalino è beige con pagliuzze dorate, mentre varia il colore dell'elemento sferico detto "cipolla".

An elegant floor lamp inspired by the classical canons of symmetry and proportions, rendered timeless by the warm and caressing colours: the opaline diffuser is beige, speckled with gold, while the sphere element, called "cipolla" can be of different colours.

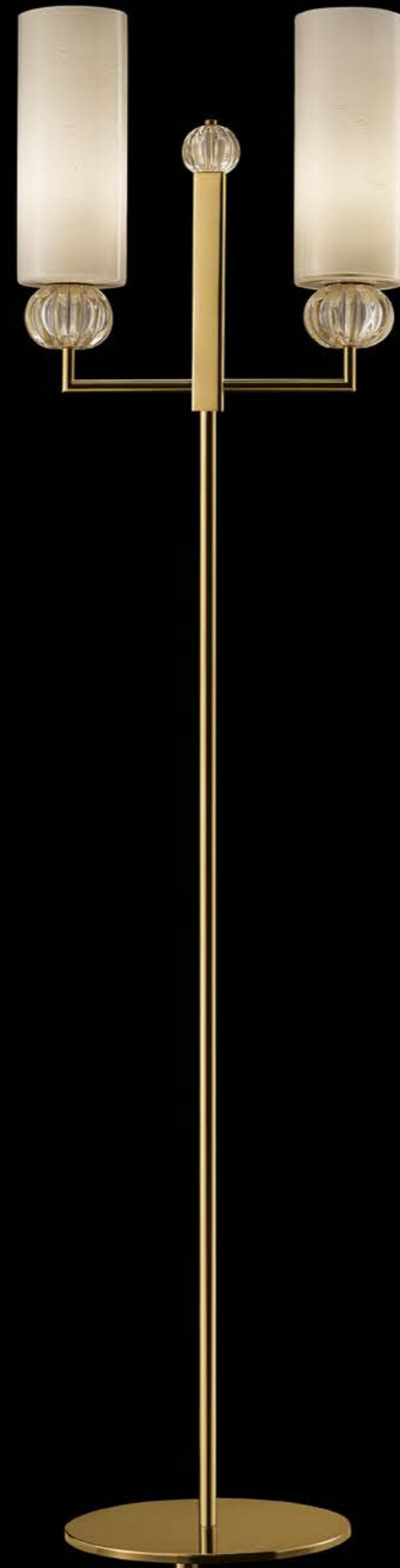

Modelli e misure Models and sizes

Gallia
5626-00

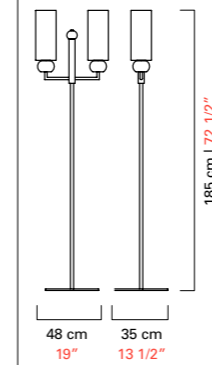

Peso Weight	15 kg 33 lb
Lampadine Bulbs	N. Tipo W max. N. Type W max.
	2 E27 100 E26 60
Dimmerabile Dimmable	D
Lampadine incluse Bulbs included	
Certificazioni Certification Marks	UL EAC c UL US

Colori disponibili Available colours

*A ogni colore è sempre abbinata la foglia oro.
Each colour is always combined with gold leaf.



OY
Oro Beige/ Oro
Gold Beige/ Gold



OW
Oro Beige/
Verde Oro
Gold Beige/
Green Gold



OK
Oro Beige/
Nero Oro
Beige Gold/
Black Gold

Finiture Finishings



OG
Oro Galvanizzato
Galvanized Gold



OF
Ottone
Spazzolato Fine
Fine Brushed Brass

MARTA

Una lampada da terra con un fusto molto esile dove sono allineate sfere in cristallo veneziano lavorate con la tradizionale tecnica a "corteccia". La massa vetrosa ancora calda viene fatta rotolare abilmente su di uno stampo piatto a lamelle e poi, successivamente, soffiata per ottenere una superficie irregolare e tridimensionale che ricorda quella della corteccia di un albero.

A floor lamp with a very slender stem bearing aligned Venetian crystal spheres worked with the traditional "corteccia" technique. The hot glass is skilfully turned on a flat lamellar plate and then blown to obtain an irregular three-dimensional surface, resembling the bark of a tree.



Modelli e misure Models and sizes

Marta
5577-00

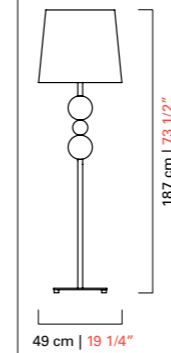

Peso Weight	14 kg 31 lb
Lampadine Bulbs	N. Tipo W max. 1 E27 250 N. Type W max. E26 250
Dimmerabile Dimmable	D
Lampadine incluse Bulbs included	
Certificazioni Certification Marks	UL ENEC c UL US

Colori disponibili Available colours



CC
Cristallo
Crystal



IC
Grigio
Grey



EK
Sabbia
Sand



DK
Oliva
Olive



AK
Blu Cadetto
Cadet Blue



LQ
Bluastro
Bluastro



FK
Indaco
Indigo



CK
Perivinka
Periwinkle



VI
Viola
Violet



OO
Oro
Gold

Finiture Finishings



CL
Cromo Lucido
Polished Chrome



CN
Cromo Nero
Dark Chrome



OF
Ottone
Spazzolato Fine
Fine Brushed Brass

Paralumi Shades

Esterno: Cotone
External: Cotton

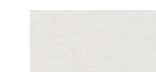
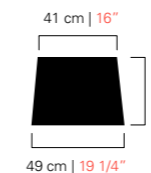

BB
Bianco
White



NN
Nero
Black

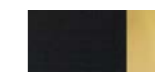

NO
Nero Interno Oro
Black Inner Gold

OPÉRA

Philippe Nigro

Opéra è una collezione di lampade ispirata all'Opéra Garnier, in cui l'elemento principale è la lavorazione del rostrato. La forma cilindrica va ad enfatizzare il motivo ornamentale, moltiplicando gli angoli di incidenza dei raggi luminosi e creando un fitto involuppo di punte tridimensionali. Alle creazioni in Cristallo Veneziano sono abbinati elementi metallici dalla silhouette molto affine, che circondano e sostengono i corpi luminosi. Il modello da tavolo presenta un'estetica ancora più avvolgente, capace di creare, anche da spenta, un'atmosfera calda e preziosa.

Opéra is a collection of lamps inspired by the Opéra Garnier, where the main feature is the rostrato. The cylindrical form underscores the ornamental motif, multiplying the angles of impact of beams of light and creating a dense wrapping of three-dimensional points. The creations in Venetian Crystal are joined by metal parts with a very similar silhouette, which surround and support the luminous volumes: completely different textures, sharing a specific inspiration in their shapes and substance. The table model has an even more enveloping look, and is able to create a warm, precious atmosphere even when the lamp is off.

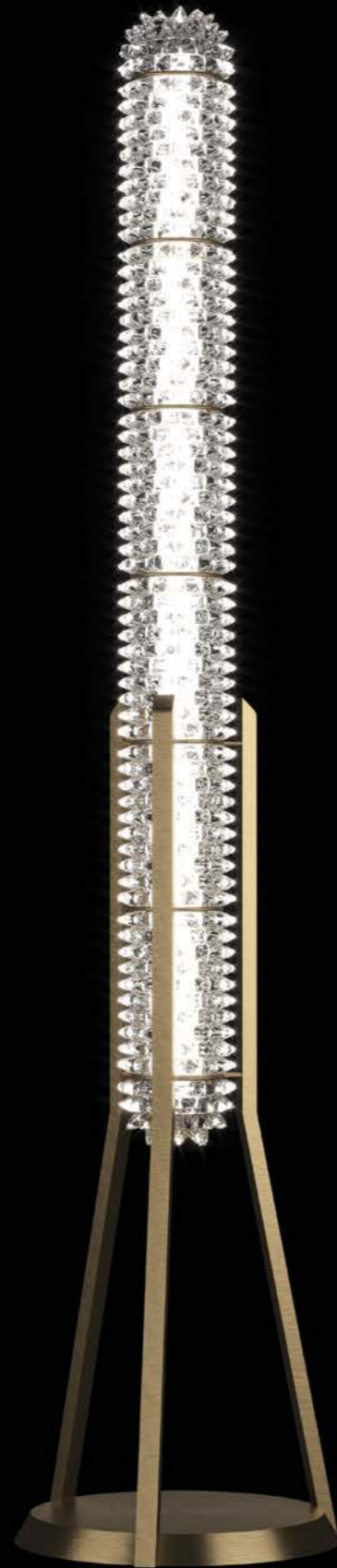

Modelli e misure Models and sizes

Opéra
7392-00

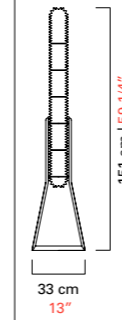

Peso Weight	25 kg 55 lb
Lampadine Bulbs	N. Tipo W max. 1 Strip Led 32 N. Type W max. Strip Led 32
Dimmerabile Dimmable	D
Lampadine incluse Bulbs included	Strip Led
Certificazioni Certification Marks	EAC c UL US

Colori disponibili Available colours



CC
Cristallo
Crystal

Finiture Finishings



NJ
Nickel Nero
Spazzolato
Brushed Black
Nickel



OJ
Oro Spazzolato
Brushed Gold

PERSEUS

Marcel Wanders

Una lampada da terra composta da elementi in cristallo veneziano che rappresentano quasi un compendio delle tecniche vetrarie studiate e sviluppate da Barovier&Toso nel corso della sua lunga storia, qui reinterpretate, accostate e mescolate in modo sovversivo rispetto ai canoni della classicità.

This floor lamp is composed of a large number of Venetian crystal elements that represent a compendium of the glassmaking techniques studied and developed by Barovier&Toso in the course of its long history, here reinterpreted, paired, and mixed in a subversive way with respect to the canons of classicism.



Modelli e misure Models and sizes

Perseus
7313-00

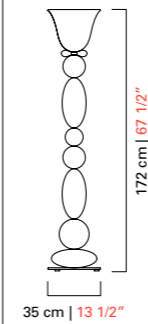

Peso Weight	20 kg 44 lb
Lampadine Bulbs	N. Tipo W max. 1 E27 60 N. Type W max. E26 60
Dimmerabile Dimmable	D
Lampadine incluse Bulbs included	
Certificazioni Certification Marks	UL ENEC UL US

Colori disponibili Available colours



WZ
Cristallo/
Cedro liquido/
Acquamarine/ Grigio/
Bianco
*Crystal/ Liquid
Citron/ Aquamarine/
Grey/ White*

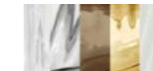

WP
Cristallo/ Grigio/
Brown/ Cognac/
Bianco
*Crystal/ Grey/
Brown/ Cognac/
White*

Finiture Finishings



CL
Cromo Lucido
Polished Chrome

ROTTERDAM

Fusto con elementi ogivali e rocchetti di cristallo creati artigianalmente utilizzando un brevetto Barovier&Toso: il "rostrato". Oggetto prezioso, di straordinaria eleganza e raffinatezza capace di soddisfare un cliente esigente e sofisticato.

A trunk with oval elements and crystal spoils created by hand using a Barovier&Toso patent: "rostrato". A precious object of extraordinary elegance and refinement, capable of satisfying the most demanding and sophisticated customers.



Modelli e misure Models and sizes

Rotterdam

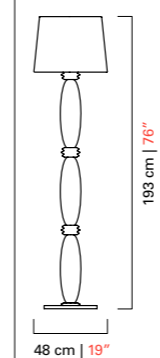
7353-00

Peso Weight	19 kg 42 lb
Lampadine Bulbs	N. Tipo W max. 1 E27 100 N. Type W max. E26 100
Dimmerabile Dimmable	D
Lampadine incluse Bulbs included	
Certificazioni Certification Marks	UL ENEC UL US

Colori disponibili Available colours



CC
Cristallo
Crystal



IC
Grigio
Grey



EK
Sabbia
Sand



DK
Oliva
Olive



AK
Blu Cadetto
Cadet Blue



LQ
Bluastro
Bluastro



FK
Indaco
Indigo



CK
Perivinka
Periwinkle



VI
Viola
Violet



OO
Oro
Gold

Finiture Finishings



CL
Cromo Lucido
Polished Chrome



CN
Cromo Nero
Dark Chrome



OF
Ottone
Spazzolato Fine
Fine Brushed Brass

Paralumi Shades

Esterno: Cotone
External: Cotton

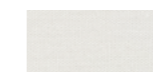
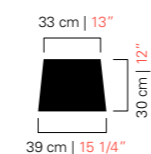

BB
Bianco
White

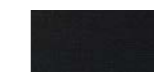

NN
Nero
Black

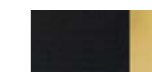

NO
Nero Interno Oro
Black Inner Gold

SAMURAI

Angelo Barovier

Angelo Barovier, nel 1966, progettava una lampada con costolature che successivamente è stata ripresa, ingigantita, messa sotto sopra e moltiplicata, fino ad ottenere un oggetto dalle dimensioni generose. Il disegno è caratterizzato da linee piramidali che fanno pensare ad un Samurai in posizione di riposo. Il cristallo veneziano con cui è realizzata è molto massiccio e la sua esecuzione richiede la mano e la forza di un esperto maestro vetraio.

Angelo Barovier had an idea for a ribbed lamp in 1966. Then his design was revisited, but this time inverted, repeated and created on a giant scale. Its pyramid shape recalls of a Samurai at rest. The Venetian crystal used for this piece is extremely massive, and working it requires the skill and strength of an experienced master glassmaker.



Modelli e misure Models and sizes

Samurai
7054-00

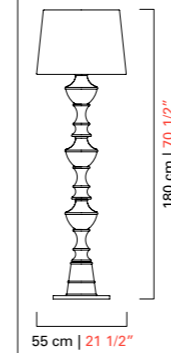

Peso Weight	16 kg 35 lb
Lampadine Bulbs	N. Tipo W max. 3 E14 60 N. Type W max. E12 60
Dimmerabile Dimmable	D
Lampadine incluse Bulbs included	
Certificazioni Certification Marks	UL ENEC UL US

Colori disponibili Available colours



CC
Cristallo
Crystal



IC
Grigio
Grey



EK
Sabbia
Sand



DK
Oliva
Olive



AK
Blu Cadetto
Cadet Blue



LQ
Bluastro
Bluastro



FK
Indaco
Indigo



CK
Pervinca
Periwinkle



VI
Viola
Violet



OO
Oro
Gold

Finiture Finishings

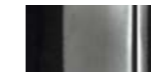

CN
Cromo Nero
Dark Chrome



OF
Ottone
Spazzolato Fine
Fine Brushed Brass

Paralumi Shades

Esterno: Cotone
External: Cotton

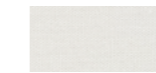
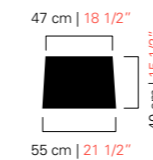

BB
Bianco
White



NN
Nero
Black



NO
Nero Interno Oro
Black Inner Gold













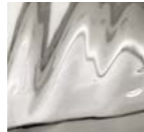
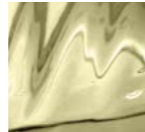







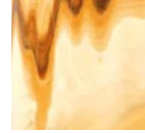

BESPOKE

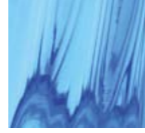







Ci sono oltre 700 anni di sartorialità Made in Italy in tutto ciò che creiamo. Un “savoir faire” che si svela nella realizzazione di tutti i nostri prodotti, ognuno dei quali ha una sua storia distintiva. Il catalogo Barovier&Toso offre un’ampia gamma di collezioni, ciascuna con innumerevoli possibili combinazioni tra dimensioni, colori del cristallo veneziano, finiture metalliche e paralumi. Se all’interno di questa gamma il cliente non dovesse trovare il suo prodotto ideale, Barovier&Toso è in grado di aiutarlo nella personalizzazione secondo le specifiche esigenze al fine di creare un oggetto unico e prezioso. Essendo infatti ogni prodotto realizzato interamente a mano e in maniera artigianale nelle nostre fornaci di Murano, può essere “cucito” su misura. I nostri consulenti sono sempre a disposizione per guidare il cliente nella personalizzazione del prodotto che può spaziare da piccole variazioni sulle dimensioni e colori sino all’ideazione e creazione di un progetto custom.

Everything we create is based on over 700 years of sartorial prowess Made in Italy. This know-how is clearly perceptible in the making of all our products, each of which has its own distinctive story. The Barovier&Toso catalogue offers a wide range of collections, all with countless possible combinations in terms of size, the colours of Venetian crystal, the metal finishings and shades. Should a customer fail to find his or her ideal product in this range, Barovier&Toso can help to personalize creations based on specific requirements, to generate a unique, precious object. Since every item is made entirely by hand by skilled craftsmen in our glassworks in Murano, the pieces can be truly “tailored” to meet all tastes. Our consultants are always available to guide clients in the personalization of products, ranging from small variations of sizes and colours to the invention and manufacture of a custom design.

Colori disponibili
Available colours



					
CC Cristallo <i>Crystal</i>	BB Bianco <i>White</i>	IC Grigio <i>Grey</i>	DK Oliva <i>Olive</i>	EL Cedro Liquido <i>Liquid Citron</i>	VA Verde Antalia <i>Antalia Green</i>
					
AT Argento <i>Silver</i>	OO Oro <i>Gold</i>	BW Brown <i>Brown</i>	EK Sabbia <i>Sand</i>	CG Cognac <i>Cognac</i>	CA Caramello <i>Caramel</i>
					
AK Blu Cadetto <i>Cadet Blue</i>	AQ Acquamarine <i>Aquamarine</i>	BL Bluino <i>Light Blue</i>	LQ Bluastro <i>Bluastro</i>	FK Indaco <i>Indigo</i>	
					
VI Viola <i>Violet</i>	AM Ametista <i>Amethyst</i>	CK Pervinca <i>Periwinkle</i>	RS Rosé <i>Light Pink</i>		

Finiture
Finishing

			
CL Cromo Lucido <i>Polished Chrome</i>	CN Cromo Nero <i>Dark Chrome</i>	NJ Nichel Nero Spazzolato <i>Brushed Black Nickel</i>	OJ Oro Spazzolato <i>Brushed Gold</i>
			
OF Ottone Spazzolato Fine <i>Fine Brushed Brass</i>	OL Ottone Lucido <i>Polished Brass</i>	OG Oro Galvanizzato <i>Galvanized Gold</i>	OU Oro Opaco <i>Matt Gold</i>

Paralumi Standard
Standard Shades

Esterno: Cotone
External: Cotton

		
BB Bianco <i>White</i>	NN Nero <i>Black</i>	NO Nero Interno Oro <i>Black Inner Gold</i>

Paralumi Speciali
Special Shades

Esterno: Cotone
External: Cotton

					
SD Sabbia <i>Sand</i>	GR Grigio Chiaro <i>Light Grey</i>	MM Moca <i>Mocha</i>	MU Muschio <i>Moss</i>	YU Blu Savoia <i>Savoy Blue</i>	YR Blu Reale <i>Royal Blue</i>

Esterno: Seta
External: Silk

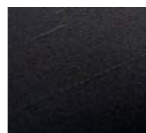
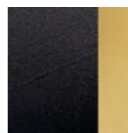
		
SW Bianco Seta <i>Silk White</i>	SK Nero Seta <i>Silk Black</i>	SI Nero Seta Interno Oro <i>Silk Black Inner Gold</i>

Nota: Per ogni combinazione personalizzata colore vetro, finitura metallica e paralumi va sempre verificata la fattibilità con i nostri Consulenti Commerciali e con il nostro Design Department.
Note: For every customized combination of glass, metal finish and shades, please verify feasibility with our Sales Consultants and our Design Department.

Collezioni <i>Collections</i>	AM	AK	AQ	AT	BB	BC	BL	BW	CA	CC	CG	CK	CR	CU	DK
	Ametista <i>Amethyst</i>	Blu Cadetto <i>Cadet Blue</i>	Acquamarina <i>Aquamarine</i>	Argento <i>Silver</i>	Bianco <i>White</i>	Bianco/ Cristallo <i>White/ Crystal</i>	Bluino <i>Light Blue</i>	Brown <i>Brown</i>	Caramello <i>Caramel</i>	Cristallo <i>Crystal</i>	Cognac <i>Cognac</i>	Pervinca <i>Periwinkle</i>	Cristallo Rugiada <i>Crystal Rugiada</i>	Cristallo Decoro Bluastro <i>Crystal Bluastro Crystal Bluastro Decoration</i>	Oliiva <i>Olive</i>
Palladiano	Fare riferimento ai colori Standard della pagina prodotto.														
Palmette	Fare riferimento ai colori Standard della pagina prodotto.														
Palmyra	Fare riferimento ai colori Standard della pagina prodotto.														
Pandora	●	●	●				●	●	●	●	●	●			●
Perseus	Per i colori Standard fare riferimento alla pagina prodotto. Per i colori Bespoke verificare con il nostro Design Department.														
Pigalle (2)	●	●	●			●	●	●	●		●	●			●
Piume	Fare riferimento ai colori Standard della pagina prodotto.														
Plissé	Fare riferimento ai colori Standard della pagina prodotto.														
Première Dame	●	●	●		●		●	●	●	●	●	●			●
Président	●	●	●		●		●	●	●	●	●	●			●
Punk	Per i colori Standard fare riferimento alla pagina prodotto. Per i colori Bespoke verificare con il nostro Design Department.														
Rabat	●	●	●				●		●	●	●		●	●	
Ran Ran Round	●	●	●				●	●	●	●	●	●		●	●
Rex	Fare riferimento ai colori Standard della pagina prodotto.														
Rive Gauche	●	●	●				●	●	●	●	●	●			●
Riyadh	●	●	●		●		●	●	●	●	●	●			●
Robin	●	●	●				●	●	●	●	●	●			●
Rosati	●	●	●				●	●	●	●	●	●			●
Rotterdam	●	●	●				●	●	●	●	●	●			●
Saint Germain (3)	●	●	●				●	●	●	●	●	●			●
Samurai	●	●	●				●	●	●	●	●	●			●
San Giorgio	●	●	●		●		●	●	●	●	●	●			●
Sara	●	●	●				●	●	●	●	●	●			●
Sideris	Fare riferimento ai colori Standard della pagina prodotto.														
Spade (5)	●	●	●				●			●	●	●	●		●
Spinn	●	●	●		●		●	●	●	●	●	●			●
Swing	●	●	●				●	●	●	●	●	●			●
Taif	●	●	●		●		●	●	●	●	●	●			●
Tangeri	●	●	●				●	●	●	●	●	●			●
Topkapi (1)	●	●	●				●	●	●	●	●	●			●
Torvik	●	●	●		●		●	●	●	●	●	●			●
Trim	●	●	●				●			●	●	●			●
Trinitas	Fare riferimento ai colori Standard della pagina prodotto.														
Tuileries	Fare riferimento ai colori Standard della pagina prodotto.														
Twins	Fare riferimento ai colori Standard della pagina prodotto.														
Valiant	●	●	●				●	●	●	●	●	●			●
Vallonné	●	●	●				●	●	●	●	●	●			●
Vallonné Opale	Fare riferimento ai colori Standard della pagina prodotto.														
Venezia 1295	●	●	●				●			●	●	●			●
Veronese	Fare riferimento ai colori Standard della pagina prodotto.														
Vermont	●	●	●				●	●	●	●	●	●			●
Vertigo	●	●	●				●	●	●	●	●	●			●
Webb	Fare riferimento ai colori Standard della pagina prodotto.														
Windsor	●	●	●				●	●	●	●	●	●			●

DO	EK	EL	FK	IC	LQ	NN	OO	OY	PC	RS	VA	VI
Cristallo Decoro Oro <i>Crystal Gold Decoration</i>	Sabbia <i>Sand</i>	Cedro Liquido <i>Liquid Citron</i>	Indaco <i>Indigo</i>	Grigio <i>Grey</i>	Bluastro <i>Bluastro</i>	Nero <i>Black</i>	Oro <i>Gold</i>	Oro Beige/ Oro <i>Gold Beige/ Gold</i>	Policromo <i>Polychrome</i>	Rosé <i>Light Pink</i>	Verde Antalia <i>Antalia Green</i>	Viola <i>Violet</i>
Refer to the Standard colours on the product page.												
Refer to the Standard colours on the product page.												
Refer to the Standard colours on the product page.												
●	●	●	●	●	●		●			●	●	●
Refer to the product page for Standard colours. Check with our Design Department for Bespoke colours.												
●	●	●	●	●	●			● (2)		●		
Refer to the Standard colours on the product page.												
Refer to the Standard colours on the product page.												
	●	●	●	●	●	●	●			●	●	●
	●	●	●	●	●	●	●			●	●	●
Refer to the product page for Standard colours. Check with our Design Department for Bespoke colours.												
●	●	●	●		●		●			●		
	●	●	●	●	●		●			●	●	●
Refer to the Standard colours on the product page.												
	●	●	●	●	●		●			●	●	●
	●	●	●	●	●	●				●	●	●
	●	●	●	●	●		●			●	●	●
	●	●	●	●	●		●			●	●	●
	●	●	●	●	●	●				●	●	●
	●	●	●	●	●	●		●		●	●	●
	●	●	●	●	●		●			●	●	●
	●	●	●	●	●		●			●	●	●
	●	●	●	●	●		●			●	●	●
Refer to the Standard colours on the product page.												
	●	●	●	●	●					●		
	●	●	●	●	●					●		
	●	●	●	●	●					●	●	●
	●	●	●	●	●	●				●	●	●
	●	●	●	●	●			●		●	●	●
	●	●	●	●	●					●	●	●
	●	●	●	●	●					●	●	●
	●	●	●	●	●					●	●	●
	●	●	●	●	●					●	●	●
Refer to the Standard colours on the product page.												
	●	●	●	●	●					●		
	●	●	●	●	●					●		
Refer to the Standard colours on the product page.												
	●	●	●	●	●					●	●	●
	●	●	●	●	●					●	●	●
Refer to the Standard colours on the product page.												
	●	●	●	●	●					●	●	●

● Colori Bespoke | *Bespoke Colours*
● Colori Standard | *Standard Colours*

(1) Il colore è previsto solo per il finalino. | *The colour refers only to the final element.*

(2) Il colore OY è disponibile solo per lampadario, lampada da parete e tavolo. | *The OY colour is available only for chandelier, wall sconce and table lamp.*

(3) L'applique è disponibile solo nel colore CC. | *The CC colour is the only option for the wall sconce.*

(4) Il colore si intende solo per la decorazione a foglia. Il corpo è sempre CC. | *The color is only for the leaf decoration. The body is always CC.*

(5) Il colore si intende solo per la parte liscia. La tecnica della Rugiada è sempre CC. | *The color is only for the smooth part. The Rugiada technique is always CC.*

Caratteristiche dei prodotti

Le descrizioni e le illustrazioni del presente catalogo si intendono fornite a titolo indicativo e non impegnativo. Barovier&Toso si riserva il diritto di apportare alle proprie collezioni le eventuali modifiche di parti, dettagli e accessori che ritenesse opportune, in qualunque momento e senza avviso, ferme restando le caratteristiche essenziali dei prodotti qui descritti ed illustrati.

Autenticità, Installazione e Qualità

Ogni prodotto è corredato di Certificato di Autenticità e di libretto di Installazione e Cura, contenente le indicazioni per la corretta installazione e per una manutenzione che preservi il valore e la bellezza della lampada nel tempo. È inoltre accompagnato da una scheda di collaudo sulla quale è indicata la data al confezionamento del prodotto e le sigle di identificazione degli addetti al controllo di qualità. In caso di reclamo, il cliente dovrà sempre fornire copia della scheda. Ogni prodotto è altresì corredato.

Avviso importante

Barovier&Toso non risponde per eventuali danni a persone o cose causati da una non corretta installazione dei propri apparecchi di illuminazione, da un uso di lampadine diverse da quelle prescritte o dalla modifica delle caratteristiche tecnico-costruttive dei prodotti stessi.

Omologazioni

Tutti i nostri lampadari sono omologati

Copyright

Il materiale riportato in questo catalogo e il catalogo stesso sono tutelati dalle leggi sui diritti relativi al copyright, ai marchi commerciali e/o su altri diritti di proprietà intellettuale. Detto materiale è di proprietà di Barovier&Toso Vetrerie Artistiche Riunite srl o delle sue controllate o consociate. Il suddetto materiale comprende, a titolo meramente esemplificativo, fotografie, immagini, illustrazioni, testo, disegni, logo, marchi commerciali, veste commerciale ed eventuale altro materiale contenuto nel catalogo. Tutti i diritti riservati. È vietata la registrazione, memorizzazione, moltiplicazione in copie, riproduzione, ulteriore pubblicazione, esposizione, esibizione, trasmissione, distribuzione, trasferimento, traduzione, trasposizione, modifica, anche parziale, di tali contenuti (consistano essi in informazioni, grafica, testi, immagini e qualsiasi altra espressione creativa) in qualsiasi forma e con qualsiasi mezzo (elettronico, meccanico, telematico, a mezzo di fotocopie, stampe, microfilm, registrazioni su qualsiasi supporto), salvo preventiva e specifica autorizzazione da parte di Barovier&Toso Vetrerie Artistiche Riunite srl. Qualora venga concessa la preventiva autorizzazione scritta alla riproduzione, è fatto comunque obbligo di citarne la fonte.

Marchio registrato

Barovier&Toso è un marchio registrato in tutto il mondo.

Main features of the products

Specifications and pictures contained in this catalogue are indicative but not binding. Therefore, while keeping the main features of the above described models, Barovier&Toso reserves the rights to modify parts, details and fittings of its collection range whenever it deems it necessary, without previous notice to its customers.

Installation instructions and quality test

Each item is accompanied by its own “dossier” including a certificate of authenticity and a card containing quality control inspections and installation instructions. This card shows both the packing date and the identification marks of the inspectors. In case of compliant, the customer should send us a copy of this card, which also contains instructions for correct assembly of the fixture.

Important notice

Barovier&Toso is not liable for injuries or damages due to incorrect installation of its fixtures, use of bulbs different from those prescribed, modification of the original constructional or technical characteristics of the items.

Certifications

All our items comply with the standard of

Copyright notice

All materials on this catalogue and the catalogue itself, are protected by copyrights, trademarks and/or other intellectual property rights. These materials are owned by Barovier&Toso Vetrerie Artistiche Riunite srl or its subsidiaries or affiliates. Such materials include, but are not limited to, the photographs, images, illustrations, text, designs, logos, trademarks and other materials contained in this catalogue. All rights are reserved, worldwide. You may not record, store, copy, reproduce, republish, publicly exhibit, post, transmit, distribute, transfer, translate, transpose, modify, in whole or in part, any such material (information, artwork, text, pictures and the like), in any form or by any electronic, mechanical, photocopying, recording or any other means (including CD-ROM) without first obtaining the case-by-case prior consent of Barovier&Toso Vetrerie Artistiche Riunite srl. When the reproduction has been previously authorized, the use is permitted only if the source for the material has been clearly stated.

Registered trade-mark

Barovier&Toso is a registered trade-mark all over the world.

Certificazioni



Il marchio IMQ è utilizzato per apparecchi elettrici e componenti. Attesta la conformità dei prodotti elettrici ai requisiti delle norme CEI ed EN.



Il certificato cinese obbligatorio, comunemente noto come marchio CCC (China Compulsory Certification), è un marchio di sicurezza elettrica obbligatorio per molti prodotti venduti sul mercato cinese.



cULus

I marchi UL e cULus indicano che UL ha testato dei campioni rappresentativi di un prodotto, valutandoli idonei agli standard applicabili o ad altri requisiti, in relazione ai loro potenziali rischi di incendio, shock elettrico e pericoli meccanici. I marchi UL e cULus su un prodotto testimoniano la costante conformità del produttore alle norme di sicurezza applicabili.

EAC

Il certificato di coformità EAC è il marchio di sicurezza dell’Unione Economica Euroasiatica: Federazione Russa, Armenia, Bielorussia, Kazakistan and Kirghizistan. I certificati e le dichiarazioni EAC confermano che il prodotto dell’azienda in oggetto soddisfa i requisiti dei regolamenti tecnici della EAEU ed è sicuro da usare.

Certification Marks



IMQ mark is used for electrical appliances and components. The IMQ mark certifies that electrical products comply with the requirements of CEI and EN standards.



CCC is short for China Compulsory Certification scheme which requires manufacturers to obtain electrical approval for their products before they can be legally marketed in China.



cULus

In addition to a typical safety certification, UL also certifies certain products for functional safety. Based on a product’s application and usage, the functional safety assessment is performed in accordance with the requirements of a published and relevant functional safety standard. Functional safety is the part of overall safety that depends on the correct functioning of safety-related control systems and software.

EAC

EAC certificate of conformity is the safety mark for the Eurasian Economic Union: Russian Federation, Armenia, Belarus, Kazakhstan and Kyrgyzstan. EAC Certificates and Declarations confirm that their subject product meets the requirements of Technical Regulations of the EAEU and is safe to use.

CHANDELIERS

4604	24
4607	26
Adonis	28
Agadir	32
Alexandria	34
Amsterdam Domo	36
Babylon	42
Baikal	44
Bissa Boba	46
Degas	48
Dhamar	50
Fauve	52
Fez	54
Florian	56
Izmir	58
Magritte	60
Maryland	64
Meknes	68
Metropolis	70
Nevada	74
Odile	78
Palladiano	80
Pigalle	84
Première Dame	86
Président	88
Rabat	92
Ran Round	94
Riyadh	98
Rosati	100
Rotterdam	104
Saint Germain	108
San Giorgio	110
Taif	112
Tangeri	114
Twins	116
Valiant	118
Venezia 1295	120
Vermont	124
Vertigo	126
Windsor	130

SUSPENSIONS

Agave	134
Angel	136
Campanula	138
Clepsydra	142
Colimaçon	146
Crown	150
Empire	154
Eva	156
Exagon	158
Fanali Veneziani	160
Gallia	164
Germogli	166
Hanami	170
Marta	174
Matrioska	176
Medina	180
Midtown	182
New Felci	186
Opéra	190
Padma	194
Palmette	198
Palmyra	202
Pandora	206
Perseus	208
Pigalle	210
Piume	212
Punk	216
Rex	218
Robin	220
Spade	222
Spinn	224
Swing	228
Trim	232
Vallonné	234
Vallonné Opale	238
Webb	240

CEILING

Agave	244
Alumina	246
Anversa	248
Clepsydra	250
Empire	252
Excelsior	254
New Felci	258
Palmette	260
Pigalle	262
Piume	264
Plissé	266
Rex	268
Spade	272
Topkapi	274
Trim	276
Webb	280

WALL

4604	286
4607	288
Adonis	290
Agadir	292
Agave	294
Alexandria	296
Alumina	298
Amsterdam Domo	300
Angel	302
Anversa	304
Babylon	306
Baikal	308
Bissa Boba	310
Clepsydra	312
Degas	314
Dhamar	316
Empire	318
Excelsior	320
Fauve	322
Fez	324
Florian	326
Gallia	328
Izmir	330
Magritte	332

Maryland	334
Matrioska	336
Medina	338
Meknes	340
Metropolis	342
Midtown	344
Nevada	346
New Felci	348
Odile	350
Opéra	352
Palladiano	354
Palmette	356
Pandora	358
Perseus	360
Pigalle	362
Piume	364
Plissé	366
Première Dame	368
Président	370
Rabat	372
Ran Round	374
Rex	376
Riyadh	378
Rosati	380
Rotterdam	382
Saint Germain	384
San Giorgio	386
Spade	388
Taif	390
Tangeri	392
Torvik	394
Tuileries	396
Twins	400
Valiant	402
Venezia 1295	404
Vermont	406
Vertigo	408
Webb	410
Windsor	414

TABLE

Amsterdam	418
Camparino	420
Ercole	422
Eva	424
Gallia	426
Grace	428
Marta	430
Medina	432
Opéra	434
Padma	436
Perseus	438
Pigalle	440
Ran	442
Rive Gauche	444
Rotterdam	446
Saint Germain	448
Samurai	450
Sara	452
Sideris	454
Trinitas	456
Twins	458
Veronese	460

FLOOR







Amsterdam	464
Conterie	466
Ercole	468
Eva	470
Gallia	472
Marta	474
Opéra	476
Perseus	478
Rotterdam	480
Samurai	482

BESPOKE

Colori Colours	486
Finiture Finishing	486
Paralumi Shades	487

INDICE 2 | INDEX 2

						
PRODUCT	CHANDELIERS	SUSPENSIONS	CEILING	WALL	TABLE	FLOOR
4604	24-25			286-287		
4607	26-27			288-289		
Adonis	28-31			290-291		
Agadir	32-33			292-293		
Agave		134-135	244-245	294-295		
Alexandria	34-35			296-297		
Alumina			246-247	298-299		
Amsterdam	36-41			300-301	418-419	464-465
Amsterdam Domo	36-41			300-301		
Angel		136-137		302-303		
Anversa			248-249	304-305		
Babylon	42-43			306-307		
Baikal	44-45			308-309		
Bissa Boba	46-47			310-311		
Campanula		138-141				
Camparino					420-421	
Clepsydra		142-145	250-251	312-313		
Colimaçon		146-149				
Conterie						466-467
Crown		150-153				
Degas	48-49			314-315		
Dhamar	50-51			316-317		
Empire		154-155	252-253	318-319		
Ercole					422-423	468-469
Eva		156-157			424-425	470-471
Exagon		158-159				
Excelsior			254-257	320-321		
Fanali Veneziani		160-163				
Fauve	52-53			322-323		
Fez	54-55			324-325		
Florian	56-57			326-327		
Gallia		164-165		328-329	426-427	472-473
Germogli		166-169				
Grace					428-429	
Hanami		170-173				
Izmir	58-59			330-331		
Magritte	60-63			332-333		
Marta		174-175			430-431	474-475
Maryland	64-67			334-335		
Matrioska		176-179		336-337		
Medina		180-181		338-339	432-433	
Meknes	68-69			340-341		
Metropolis	70-73			342-343		
Midtown		182-185		344-345		
Nevada	74-77			346-347		
New Felci		186-189	258-259	348-349		
Odile	78-79			350-351		

						
PRODUCT	CHANDELIERS	SUSPENSIONS	CEILING	WALL	TABLE	FLOOR
Opéra		190-193		352-353	434-435	476-477
Padma		194-197			436-437	
Palladiano	80-83			354-355		
Palmette		198-201	260-261	356-357		
Palmyra		202-205				
Pandora		206-207		358-359		
Perseus		208-209		360-361	438-439	478-479
Pigalle	84-85	210-211	262-263	362-363	440-441	
Piume		212-215	264-265	364-365		
Plissé			266-267	366-367		
Première Dame	86-87			368-369		
Président	88-91			370-371		
Punk		216-217				
Rabat	92-93			372-373		
Ran					442-443	
Ran Round	94-97			374-375		
Rex		218-219	268-271	376-377		
Rive Gauche					444-445	
Riyadh	98-99			378-379		
Robin		220-221				
Rosati	100-103			380-381		
Rotterdam	104-107			382-383	446-447	480-481
Saint Germain	108-109			384-385	448-449	
Samurai					450-451	482-483
San Giorgio	110-111			386-387		
Sara					452-453	
Sideris					454-455	
Spade		222-223	272-273	388-389		
Spinn		224-227				
Swing		228-231				
Taif	112-113			390-391		
Tangeri	114-115			392-393		
Topkapi			274-275			
Torvik				394-395		
Trim		232-233	276-279			
Trinitas					456-457	
Tuileries				396-399		
Twins	116-117			400-401	458-459	
Valiant	118-119			402-403		
Vallonné		234-237				
Vallonné Opale		238-239				
Venezia 1295	120-123			404-405		
Vermont	124-125			406-407		
Veronese					460-461	
Vertigo	126-129			408-409		
Webb		240-241	280-283	410-413		
Windsor	130-131			414-415		

Barovier&Toso
Vetriere Artistiche Riunite srl

Headquarter
Fondamenta Vetrai 28
30141 Murano Venezia | Italy
T. (+39) 041 739 049
info@barovier.com

Marketing Office
Via Durini 5
20122 Milano | Italy
T. (+39) 02 778 78 600
press@barovier.com

Palazzo Barovier&Toso
Fondamenta Manin 1/D | 30141 Murano
palazzo@barovier.com

Showroom Barovier&Toso
Via Durini 5 | 20122 Milano
showroom.milano@barovier.com

barovier.com

Segnalibri | Bookmarks

Lampadario
Chandelier

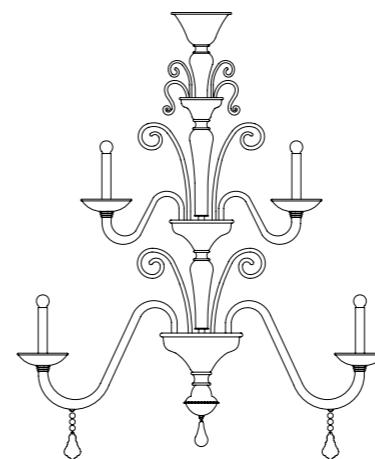

Sospensione
Suspension

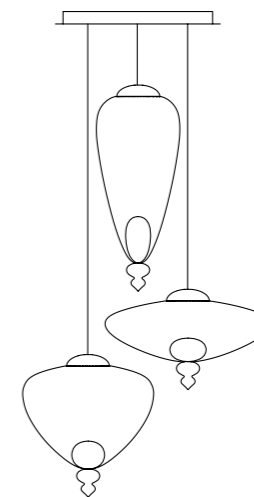

Soffitto
Ceiling

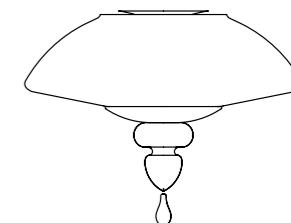

Parete
Wall

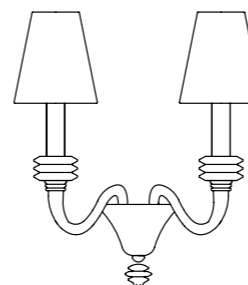

Tavolo
Table

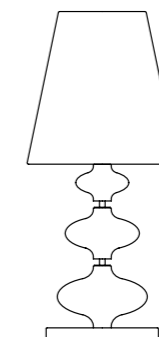

Terra
Floor

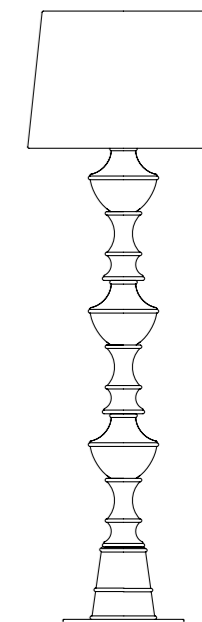

Soffitto
Ceiling

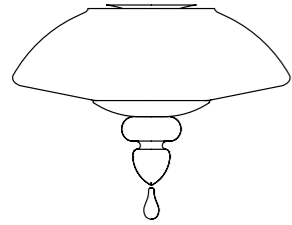

Sospensione
Suspension

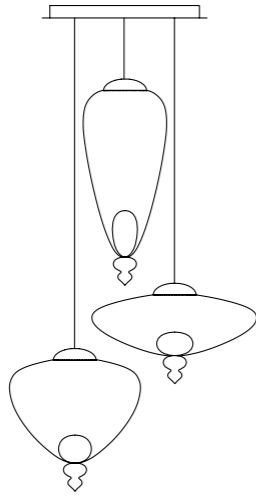

Lampadario
Chandelier

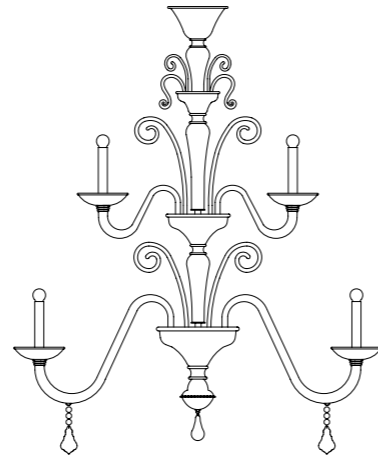

Terra
Floor

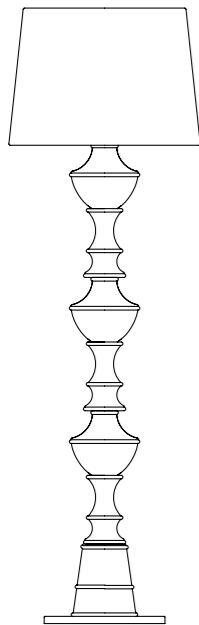

Tavolo
Table

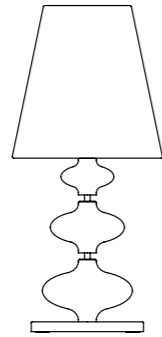

Parete
Wall

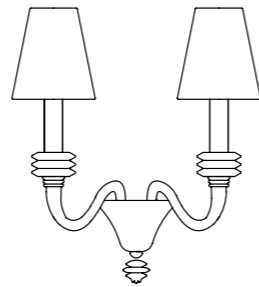



barovier.com