

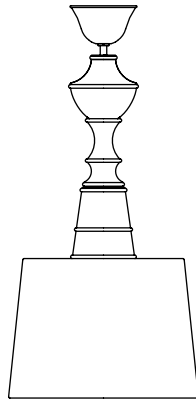

# Barovier&Toso

VENEZIA 1295



## SAMURAI

*Angelo Barovier*



Angelo Barovier, nel 1966, progettava una lampada con costolature che successivamente è stata ripresa, ingigantita, messa sotto sopra e moltiplicata, fino ad ottenere un oggetto dalle dimensioni generose. Il disegno è caratterizzato da linee piramidali che fanno pensare ad un Samurai in posizione di riposo. Il cristallo veneziano con cui è realizzata è molto massiccio e la sua esecuzione richiede la mano e la forza di un esperto maestro vetraio.

*Angelo Barovier had an idea for a ribbed lamp in 1966. Then his design was revisited, but this time inverted, repeated and created on a giant scale. Its pyramid shape recalls of a Samurai at rest. The Venetian crystal used for this piece is extremely massive, and working it requires the skill and strength of an experienced master glassmaker.*





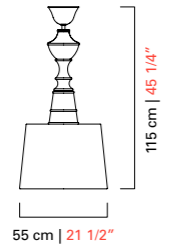

<b>Modelli e misure</b> <i>Models and sizes</i>	Samurai <b>7053-00</b>		
			
<b>Peso</b> <b>Weight</b>	15 kg 33 lb		
<b>Lampadine</b> N. Tipo W max. <b>Bulbs</b> N. Type W max.	3	E14	60
<b>Dimmerabile</b> <b>Dimmable</b>	D		
<b>Lampadine incluse</b> <b>Bulbs included</b>			
<b>Certificazioni</b> <b>Cerification Marks</b>			

**Colori disponibili**  
*Available colours*



 <b>CC</b> Cristallo <i>Crystal</i>	 <b>IC</b> Grigio <i>Grey</i>	 <b>EK</b> Sabbia <i>Sand</i>	 <b>DK</b> Oliva <i>Olive</i>	 <b>AK</b> Blu Cadetto <i>Cadet Blue</i>
 <b>LQ</b> Bluastro <i>Bluastro</i>	 <b>FK</b> Indaco <i>Indigo</i>	 <b>CK</b> Perivnca <i>Periwinkle</i>	 <b>VI</b> Viola <i>Violet</i>	 <b>OO</b> Oro <i>Gold</i>



**Finiture**  
*Finishings*

 <b>CN</b> Cromo Nero <i>Dark Chrome</i>	 <b>OF</b> Ottone Spazzolato Fine <i>Fine Brushed Brass</i>
--	--





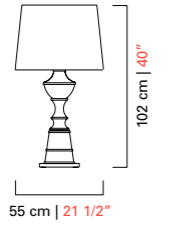
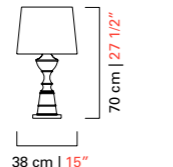
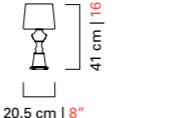
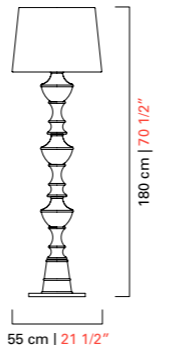



**Paralumi**  
**Shades**

Esterno: Cotone  
*External: Cotton*

 <b>BB</b> Bianco <i>White</i>	 <b>NN</b> Nero <i>Black</i>	 <b>NO</b> Nero Interno Oro <i>Black Inner Gold</i>
--	--	---

<b>Modelli e misure</b> <i>Models and sizes</i>	Samurai <b>7052-00</b>	Samurai <b>7082-00</b>	Samurai <b>7081-00</b>	Samurai <b>7054-00</b>
				
<b>Peso</b> <b>Weight</b>	12 kg 26 lb	9 kg 20 lb	7 kg 15 lb	16 kg 35 lb
<b>Lampadine</b> N. Tipo W max. <b>Bulbs</b> N. Type W max.	3 E14 60 E12 60	3 E14 40 E14 40	1 E14 40 E12 40	3 E14 60 E12 60
<b>Dimmerabile</b> <b>Dimmable</b>	D			
<b>Lampadine incluse</b> <b>Bulbs included</b>	G9 Led			
<b>Certificazioni</b> <b>Cerification Marks</b>				

**Colori bespoke**  
*Bespoke colours*

 <b>CG</b> Cognac <i>Cognac</i>	 <b>CA</b> Caramello <i>Caramel</i>	 <b>BW</b> Brown <i>Brown</i>	 <b>EL</b> Cedro Liquido <i>Liquid Citron</i>	 <b>VA</b> Verde Antalia <i>Antalia Green</i>
 <b>AM</b> Ametista <i>Amethyst</i>	 <b>RS</b> Rosé <i>Light Pink</i>	 <b>AQ</b> Acquamare <i>Aquamarine</i>	 <b>BL</b> Bluino <i>Light Blue</i>	



---

barovier.com