



Barovier&Toso

VENEZIA 1295

Work Book



Enlightening Uniqueness

In sette secoli di storia abbiamo visto mode andare e venire. Alcune minimaliste, altre più barocche, ma tutte ugualmente prese ad inseguire il tempo che passa, nella disperata ricerca del "nuovo".

A Venezia il tempo, invece, scorre lento. Non c'è fretta, solo tempo e spazio necessari per affinare un'arte.

Così, abbiamo deciso di prenderci il nostro tempo, per fare qualcosa di unico e originale. Qualcosa che possa durare per sempre. Qualcosa che vada oltre il fascino effimero di una stagione.

Ci vuole forza per plasmare il vetro dalla sabbia e dal fuoco. Ci vuole pazienza per arrivare alla forma perfetta senza compromessi e ci vuole cuore, tanto cuore, per portare una tradizione leggendaria di illuminazione di lusso fino ai giorni nostri, in un perfetto equilibrio tra passato, presente e futuro.

Ma ancora una volta possiamo permetterci il lusso del tempo. E forse, anche voi.

In seven centuries of history, we have seen fashions come and go. Some were minimal, others more baroque, but every one of them chased time in a desperate search for the "new."

Time in Venice, instead, goes by slowly. There is no rush, no craze, just a great deal of space and time to develop your craft.

So we took our time and in that time we have learned that we would rather do something unique and enlightening that lasts forever instead of something new that only fascinates you for one season.

It takes strength to bring glass out from the fire and heat. It takes patience to strive for nothing less than the perfect shape. And it takes heart, a lot of it, to grow a legendary luxury lighting tradition into the new world, working with innovators and traditionalists alike.

But again, we can afford the luxury of time. And perhaps, so can you.





Cristallo Veneziano | *Venetian Crystal*

Le creazioni Barovier&Toso sono opere uniche, in Cristallo Veneziano soffiato a bocca e realizzate a mano da maestri vetrai di Murano, depositari di una tradizione secolare che solca la storia da generazioni.

È ad Angelo Barovier che si deve l'invenzione di una rivoluzionaria formula che permise di ottenere un materiale inedito, dalle straordinarie caratteristiche di estrema trasparenza e brillantezza. Fu con decreto della Repubblica di Venezia, intorno al 1455, che Angelo Barovier ottenne addirittura l'esclusiva nella produzione del "Cristallo Veneziano".

Ciò che ancora oggi rende unica quella ricetta materica, giunta fino a noi e ulteriormente perfezionata, è la totale assenza di piombo e arsenico. Questo distingue il nostro Cristallo Veneziano da qualunque altro cristallo in commercio e rende la tecnica del cristallo soffiato, come anche tutto il processo produttivo, eseguibile in totale sicurezza da parte dei maestri vetrai.

Il Cristallo Veneziano è un materiale unico, sostenibile e sicuro, capace di dar forma ad opere di grande valore artistico, le creazioni Barovier&Toso.

Barovier&Toso produce esclusivamente Cristallo Veneziano.

The creations of Barovier&Toso are one-of-a-kind works in Venetian mouth blown Crystal and hand crafted by master artisans in Murano, custodians of an age-old tradition passed down across the generations.

Angelo Barovier invented a revolutionary formula that made it possible to obtain an unprecedented material with extraordinary characteristics of extreme transparency and brightness. Thanks to a decree issued by the Republic of Venice in 1455, Angelo Barovier was granted the exclusive right to produce "Cristallo Veneziano" (Venetian Crystal).

The factor that makes this formula unique, still used today through progressive refinements, is the total absence of lead and arsenic. This is what makes our Venetian Crystal different from any other crystal on the market, enabling the master artisans to carry out the entire production process in complete safety, achieving exceptional results.

The Venetian Crystal is a unique, sustainable and safe material, ideal to give form to works of great artistic value: the creations of Barovier&Toso.

Barovier&Toso produces exclusively Venetian Crystal.

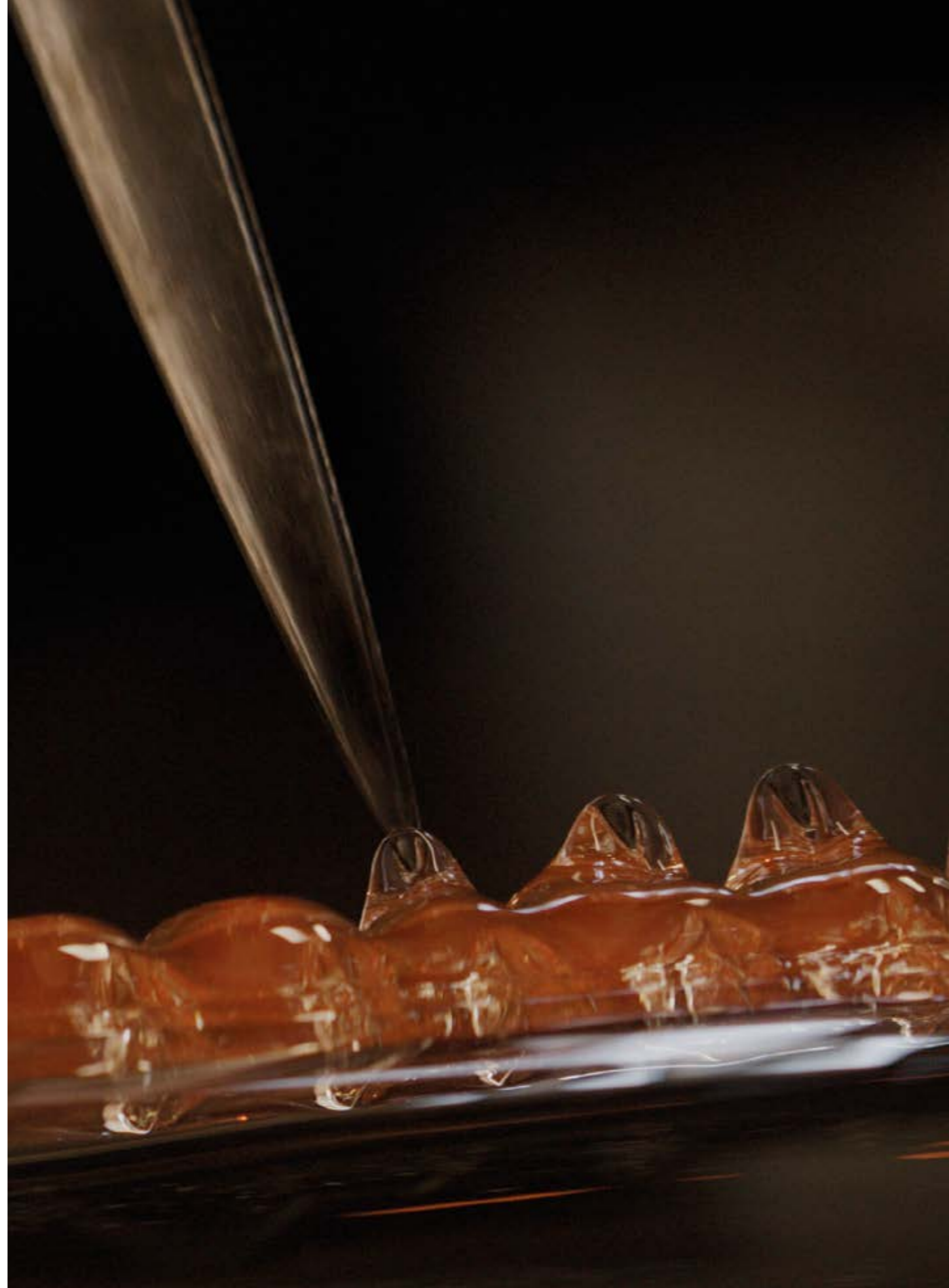

CHANDELIERS



4604
24



4607
26

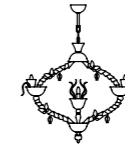

Adonis
28

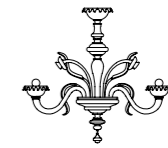

Agadir
32

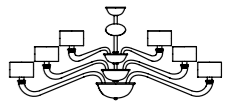

Alexandria
34

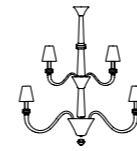

Amsterdam
36

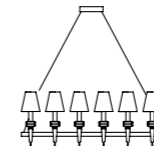

Domo Amsterdam
36

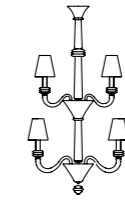

Torpedo Amsterdam
36

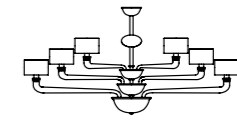

Babylon
42

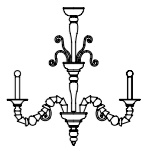

Baikal
44

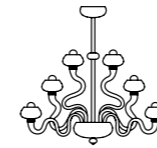

Bissa Boba
46

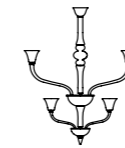

Degas
48

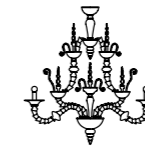

Dhamar
50

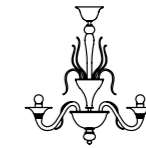

Fauve
52



Fez
54

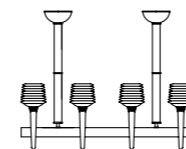

Florian
56



Izmir
58

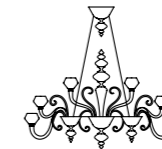

Magritte
60



Maryland
64

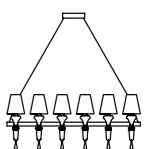

Domo Maryland
64



Meknes
70

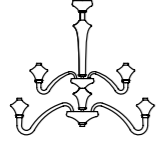

Metropolis
72



Nekhel
76

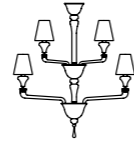

Nevada
78

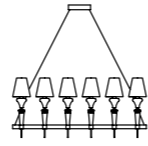

Domo Nevada
78



Taif
122

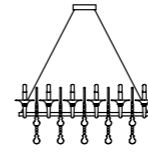

Mood Taif
122

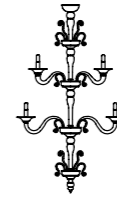

Torpedo Taif
122

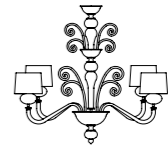

Tangeri
128

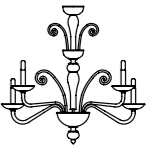

Taymyr
130

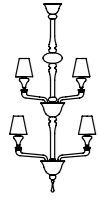

Torpedo Nevada
78

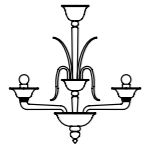

Odile
84



Palladiano
86

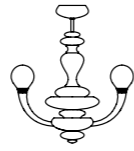

Pigalle
90

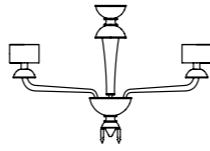

Première Dame
92

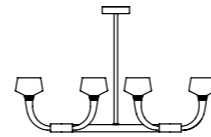

Twins
132

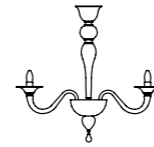

Valiant
134

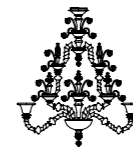

Venezia 1295
136

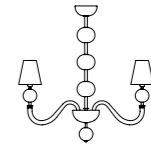

Vermont
140

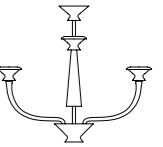

Vertigo
142

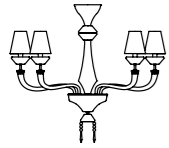

Président
94

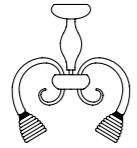

Quadri
98



Rabat
100

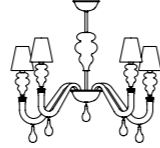

Ran Round
102



Redon
106

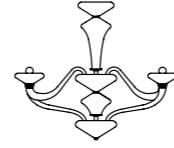

Windsor
146

SUSPENSIONS

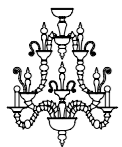

Riyadh
108

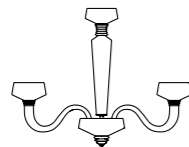

Rosati
110

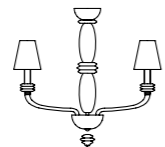

Rotterdam
114

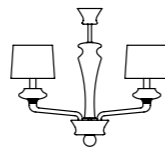

Saint Germain
118



San Giorgio
120

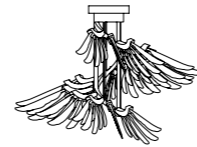

Angel
150

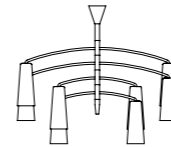

Colimaçon
152

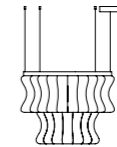

Crown
156



Eva
160

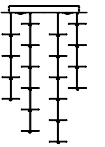

Exagon
162

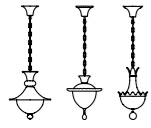

Fanali Veneziani
164

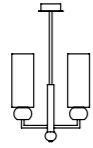

Gallia
168

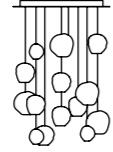

Hanami
170

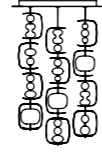

Manhattan
174

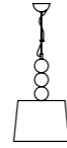

Marta
176

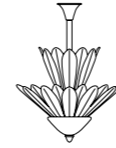

Spade
222

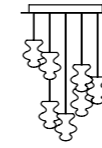

Spinn
224



Swing
228

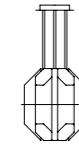

Trim
232



Vallonné
234

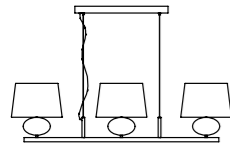

Matrioska
178

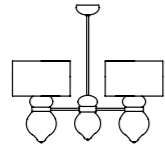

Medina
182

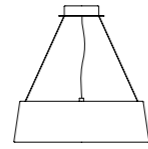

New Eden
184

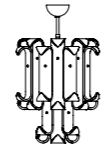

New Felci
186

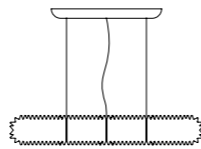

Opéra
190

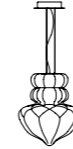

Vallonné Opale
238

CEILING



Padma
194

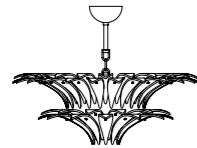

Palmette
198

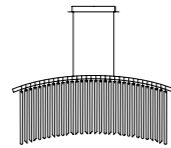

Palmyra
202

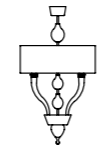

Pandora
206

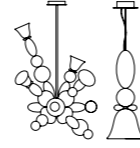

Perseus
208

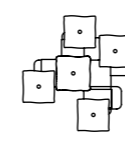

Alumina
242

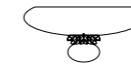

Anversa
244



Excelsior
246



Grand Hotel
250

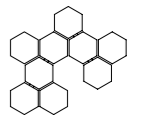

Marrakech
252

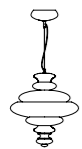

Pigalle
210

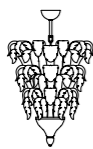

Piume
212

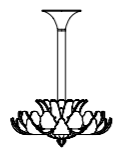

Rex
216



Robin
218



Samurai
220

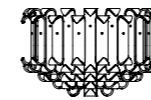

New Felci
256

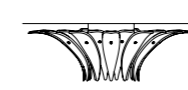

Palmette
258

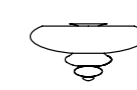

Pigalle
260

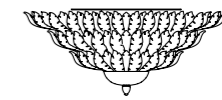

Piume
262

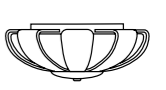

Plissé
264

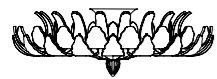

Rex
266



Royal
270



Spade
272



Topkapi
274

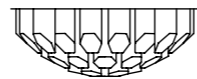

Trim
276

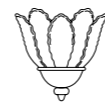

Excelsior
310



Fauve
312



Fez
314

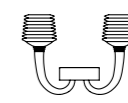

Florian
316

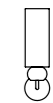

Gallia
318

WALL



4604
282



4607
284



Adonis
286



Agadir
288

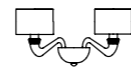

Alexandria
290



Grand Hotel
320



Izmir
322



Magritte
324



Marrakech
326



Maryland
330

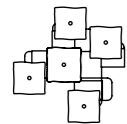

Alumina
292

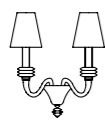

Amsterdam
294

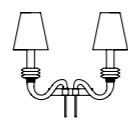

Domo Amsterdam
294



Angel
296



Anversa
298

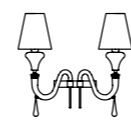

Domo Maryland
330

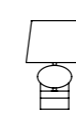

Matrioska
332

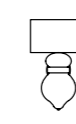

Medina
334



Meknes
336

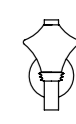

Metropolis
338

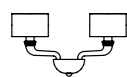

Babylon
300

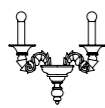

Baikal
302

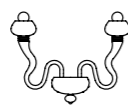

Bissa Boba
304



Degas
306



Dhamar
308

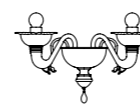

Nekhel
340



Nevada
342



Domo Nevada
342

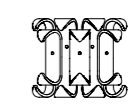

New Felci
344

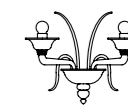

Odile
346

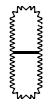

Opéra
348

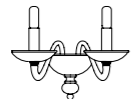

Palladiano
350



Palmette
352

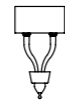

Pandora
354



Perseus
356



Spade
388



Taif
390

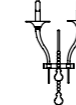

Mood Taif
390

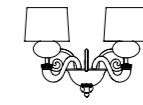

Tangeri
392



Taymyr
394



Pigalle
358



Piume
360



Plissé
362

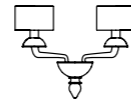

Première Dame
364



Président
366



Torvik
396

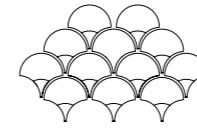

Tuileries
398

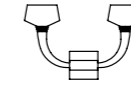

Twins
402



Valiant
404



Venezia 1295
406



Quadri
368



Rabat
370

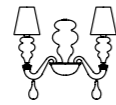

Ran Round
372



Redon
374



Rex
376

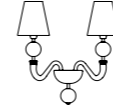

Vermont
408



Vertigo
410

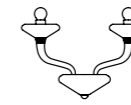

Windsor
412

TABLE



Riyadh
378

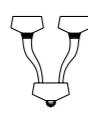

Rosati
380

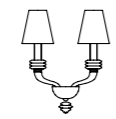

Rotterdam
382

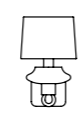

Saint Germain
384

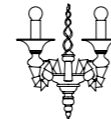

San Giorgio
386

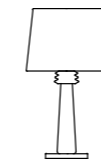

Amsterdam
416



Camparino
418

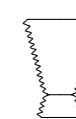

Ercole
420



Eva
422

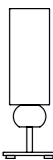

Gallia
424

FLOOR

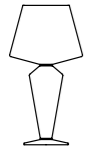

Grace
426

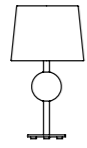

Marta
428

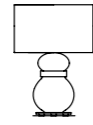

Medina
430

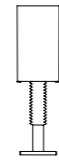

My Marilyn
432



Opéra
434

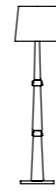

Amsterdam
460



Ercole
462



Eva
464



Gallia
466

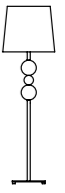

Marta
468



Padma
436

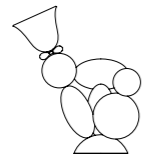

Perseus
438



Pigalle
440

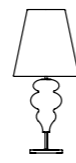

Ran
442

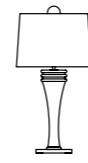

Rive Gauche
444

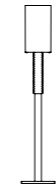

My Marilyn
470

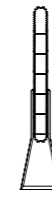

Opéra
472



Perseus
474

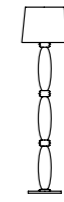

Rotterdam
476



Samurai
478

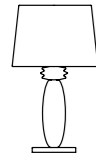

Rotterdam
446

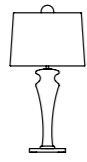

Saint Germain
448

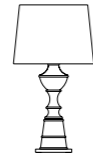

Samurai
450



Sara
452

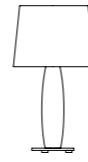

Twins
454

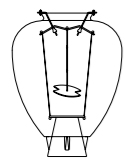

Veronese
456



CHANDELIERS

Opere d'arte intessute di luce, portatrici indiscusse di eleganza e regalità. Dai lampadari più moderni a quelli di concezione barocca dove, in modo lineare o radiale, i bracci si moltiplicano a cascata, dando vita a spettacolari effetti luminosi.

Works of art woven by light, unrivalled vehicles of regal elegance. From the most modern chandeliers to those in Baroque style, the arms multiply in linear or radial arrangements, giving rise to spectacular luminous effects.

4604

Tra i lampadari veneziani, 4604 si distingue per la sua leggerezza decorativa. Le foglie, i pinnacoli e i fiori che lo adornano possono essere realizzati tono su tono o a contrasto; elementi caratterizzanti nelle tonalità del cristallo, dell'oro e del blu che fanno di questo modello un'icona d'arredo. La collezione comprende tre lampadari.

Among the Venetian chandeliers, 4604 stands out for its decorative lightness: leaves, pinnacles and the flowers that adorn it are crystal-coloured or gilded at the most, which makes them less present but still characteristic. The collection consists of three chandeliers.



Modelli e misure Models and sizes

*Ogni modello prevede una catena di 100 cm inclusa.
Every model is supplied with a 100 cm (39 1/4") chain.

	4604 4604/09	4604 4604/12	4604 4604/18
Peso Weight	35 kg 77 lb	50 kg 110 lb	60 kg 132 lb
Lampadine Bulbs	N. Tipo W max. 9 E14 60	N. Tipo W max. 12 E14 60	N. Tipo W max. 18 E14 60
Dimmerabile Dimmable	D	D	D
Lampadine incluse Bulbs included	(01)	(01)	(01)
Certificazioni Certification Marks			

Colori disponibili Available colours



CC
Cristallo
Crystal



DO
Cristallo
Decoro Oro
Crystal Gold
Decoration



LQ
Cristallo
Decoro Bluastro
Crystal Bluastro
Decoration



***OO**
Oro
Gold
*Solo OG
Only OG



PC
Polichromo
Polychrome

Finiture Finishings



CL
Cromo Lucido
Polished Chrome



***OG**
Oro Galvanizzato
Galvanized Gold
*Solo OO
Only OO

4607

Il più classico dei lampadari veneziani, imponente nella la sua magnificenza. Fiori in pasta di vetro multicolore, una moltitudine di decorazioni e la purezza trasparente del cristallo, fanno di 4607 un lampadario destinato ai più importanti palazzi sul Canal Grande.

The most classic Venetian chandelier, impressive in its magnificence. Flowers in multi-coloured glass paste, a multitude of decorations and the transparent purity of the crystal make 4607 a chandelier suitable to the most important palaces on the Grand Canal.



Modelli e misure Models and sizes

*Ogni modello prevede una catena di 100 cm inclusa.
Every model is supplied with a 100 cm (39 1/4") chain.

	4607 4607/12	4607 4607/20	4607 4607/36
Peso Weight	65 kg 143 lb	115 kg 253 lb	220 kg 484 lb
Lampadine Bulbs	N. Tipo W max. 12 E14 60 E12 60	N. Tipo W max. 20 E14 60 E12 60	N. Tipo W max. 36 E14 60 E12 60
Dimmerabile Dimmable	D	D	D
Lampadine incluse Bulbs included			
Certificazioni Certification Marks			

Colori disponibili Available colours



CC
Cristallo
Crystal



DO
Cristallo
Decoro Oro
Crystal Gold
Decoration



LQ
Cristallo
Decoro Bluastro
Crystal Bluastro
Decoration



***OO**
Oro
Gold
*Solo OO
Only OO



PC
Polichromo
Polychrome

Finiture Finishings



CL
Cromo Lucido
Polished Chrome



***OG**
Oro Galvanizzato
Galvanized Gold
*Solo OO
Only OO

ADONIS

Marcel Wanders Studio

Adonis è una collezione creata da Marcel Wanders, ispirata alla tradizione floreale olandese e contaminata da quella vetraria muranese che, da sempre, usa i fiori come elemento distintivo. Leggiadre farfalle e boccioli di tulipano adornano i bracci di tutti i modelli, in un vortice di colori. Si compone di sei lampadari di due diverse fogge - una allungata e una più tradizionale - che possono essere combinati tra loro in un sistema modulare ad elevata personalizzazione.

Adonis is a collection created by Marcel Wanders, inspired by the Dutch floral tradition and fused with Murano glassmaking, which has always used flowers as a distinctive feature. Graceful butterflies and tulip buds adorn the arms of every model, in a swirl of colour. It is comprised of six chandeliers in two different styles - one elongated, the other more traditional - that can be combined in a modular system for the ultimate in personalization.



Modelli e misure
Models and sizes

*Ogni modello prevede una catena di 100 cm inclusa.
 Every model is supplied with a 100 cm (39 1/4") chain.

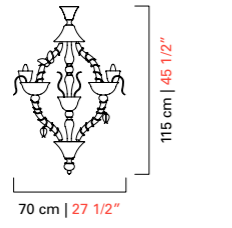
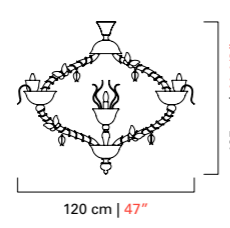
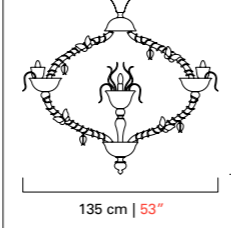
	Adonis 7360/04	Adonis 7360/11	Adonis 7360/13
Peso Weight	22 kg 48 lb	30 kg 66 lb	38 kg 84 lb
Lampadine N. Tipo W max. Bulbs N. Type W max.	4 E14 60 E12 60	11 E14 60 E12 60	13 E14 60 E12 60
Dimmerabile Dimmable	D	D	D
Lampadine incluse Bulbs included			
Certificazioni Certification Marks			

Modelli e misure
Models and sizes

*Ogni modello prevede una catena di 100 cm inclusa.
 Every model is supplied with a 100 cm (39 1/4") chain.

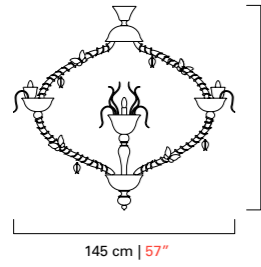
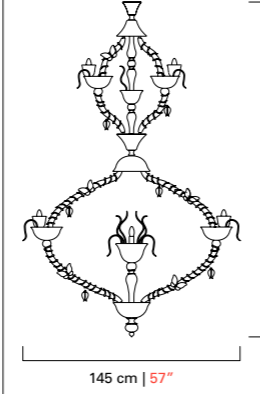
	Adonis 7360/17	Adonis 7360/21
Peso Weight	55 kg 121 lb	77 kg 170 lb
Lampadine N. Tipo W max. Bulbs N. Type W max.	17 E14 60 E12 60	21 E14 60 E12 60
Dimmerabile Dimmable	D	D
Lampadine incluse Bulbs included		
Certificazioni Certification Marks		

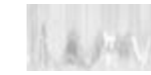
Colori disponibili
Available colours

CC
Cristallo
Crystal



AU
Cristallo / Verde
Antalia / Cedro
Liquido
Crystal / Antalia
Green / Liquid
Citron



LA
Cristallo / Bluastro /
Acquamare
Crystal / Bluastro /
Aquamarine



LN
Cristallo / Caramello
/ Cognac
Crystal / Caramel /
Cognac



EU
Bianco / Rubino
/ Rosè
White / Ruby / Light
Pink

Finiture
Finishings

CL
Cromo Lucido
Polished Chrome



***OG**
Oro Galvanizzato
Galvanized Gold
*Solo CC e LN
Only CC and LN

AGADIR

Prende ispirazione dalla città di Agadir, sulla costa meridionale atlantica del Marocco, con i suoi fiori, foglie lavorazioni a spirale molto ricche. Una collezione di quattro lampadari che è stata rieditata a partire da disegni storici dell'archivio Barovier&Toso, riadattata ora con colori eleganti e preziosi. Due modelli hanno altezza ridotta (con otto o dodici luci) mentre i modelli a sedici o diciotto luci sono più adatti a soffitti alti.

It takes inspiration from the city of Agadir, on the southern Atlantic coast of Morocco, with its flowers, leaves and very rich spiral works. It is a collection of four chandeliers that derives from historical drawings of the Barovier&Toso archives but has been endowed with new elegant and sophisticated colors. Two models come in a reduced height (with eight or twelve arms) while the models with sixteen or eighteen arms are more suitable for high ceilings.



Modelli e misure Models and sizes

*Ogni modello prevede una catena di 100 cm inclusa.
Every model is supplied with a 100 cm (39 1/4") chain.

	Agadir 5384/08	Agadir 5384/12	Agadir 5384/16	Agadir 5384/18
Peso Weight	15 kg 33 lb	20 kg 44 lb	25 kg 55 lb	30 kg 66 lb
Lampadine N. Tipo W max. Bulbs N. Type W max.	8 E14 60 E12 60	12 E14 60 E12 60	16 E14 60 E12 60	18 E14 60 E12 60
Dimmerabile Dimmable	D	D	D	D
Lampadine incluse Bulbs included				
Certificazioni Certification Marks				

Colori disponibili Available colours



CC
Cristallo
Crystal



DO
Cristallo
Decoro Oro
Crystal Gold
Crystal Gold
Decoration



LQ
Cristallo
Decoro Bluastro
Crystal Bluastro
Crystal Bluastro
Decoration



***OO**
Oro
Gold
*Solo OG
Only OG

Finiture Finishings



CL
Cromo Lucido
Polished Chrome



***OG**
Oro Galvanizzato
Galvanized Gold
*Solo OO
Only OO

ALEXANDRIA

Una collezione moderna di lampadari, composta da quattro modelli, il cui segno distintivo è l'altezza ridotta (46 cm per il modello più piccolo fino ad un massimo di 70 cm), particolarmente adatta per illuminare ambienti in cui l'altezza non consentirebbe l'utilizzo di un lampadario tradizionale. I paralumi sono in tessuto plissettato.

A collection of chandeliers with lampshade, of four models, whose distinctive sign is the reduced height (18" for the smallest model up to a maximum of 27 1/2"), particularly suitable to illuminate rooms whose height would not allow the use of a traditional chandelier. The lampshades are made of pleated fabric.



Modelli e misure Models and sizes	Alexandria 5597/08	Alexandria 5597/16	Alexandria 5597/24	Alexandria 5597/30
*Ogni modello prevede una catena di 100 cm inclusa. Every model is supplied with a 100 cm (39 1/4") chain.				
Peso Weight	10 kg 22 lb	16 kg 35 lb	22 kg 48 lb	26 kg 57 lb
Lampadine N. Tipo W max. Bulbs N. Type W max.	8 E14 60 E12 60	16 E14 60 E12 60	24 E14 60 E12 60	30 E14 60 E12 60
Dimmerabile Dimmable	D	D	D	D
Lampadine incluse Bulbs included				
Certificazioni Certification Marks				

Colori disponibili Available colours



CC
Cristallo
Crystal



IC
Grigio
Grey



EK
Sabbia
Sand



DK
Oliva
Olive



AK
Blu Cadetto
Cadet Blue



LQ
Bluastro
Bluastro



FK
Indaco
Indigo



CK
Pervinca
Periwinkle



VI
Viola
Violet



***OO**
Oro
Gold
*Solo OG
Only OG

Finiture Finishings



CN
Cromo Nero
Dark Chrome



***OG**
Oro Galvanizzato
Galvanized Gold
*Solo OO
Only OO

Paralumi Shades

Nastro Pongè
Pongee Ribbon



BB
Bianco
White



NN
Nero
Black

AMSTERDAM

Il fascino discreto della luce soffusa, calda e avvolgente. Una collezione che gioca con l'alternanza fra volumi opachi e volumi trasparenti, un dialogo fra lavorazioni diverse che esaltano la fattura del prodotto. I rocchetti realizzati con la tecnica del "rostrato" rifrangono e riflettono la luce che li colpisce creando un effetto scenografico molto suggestivo.

The discreet charm of soft, warm, enveloping light. A collection that alternates opaque and transparent volumes, in a dialogue of different crafting styles that bring out the fine workmanship of the product. Chunky crystal cylinders made with the "rostrato" technique reflect and refract the light with a dramatic effect.

Domo Amsterdam design Franco Raggi

Elegante scomposizione del lampadario classico. I bracci del lampadario Amsterdam, senza gravitare attorno al centro, si dispongono in orizzontale. L'elemento caratterizzante è il "rostrato", con le sue tipiche punte regolari. Disponibile in tre misure, ha l'altezza regolabile.

Elegant articulation of the classic chandelier. The arms of the Amsterdam chandelier, without gravitating around the center, are arranged horizontally. The characteristic element is the "rostrato" with its typical pointed elements. Available in three sizes, its height is adjustable.

Torpedo Amsterdam

Tre altezze notevoli, fino a due metri e mezzo, per illuminare spazi di dimensioni ragguardevoli. Riprendendo il braccio di Amsterdam, lampadario di grande successo con i rostrati in cristallo e i paralumi, garantisce un effetto scenografico senza paragoni.

Three notable heights, up to 98 ½" to light up areas of considerable dimensions. Recalling the arms of Amsterdam, a highly successful chandelier with "rostrato" crystal elements and shades, guarantees an unparalleled dramatic effect.





Domo Amsterdam 7115



Torpedo Amsterdam 7142/12

Modelli e misure <i>Models and sizes</i>		Amsterdam 5562/05	Amsterdam 5562/08	Amsterdam 5562/10	Amsterdam 5562/14
*Per Amsterdam e Torpedo Amsterdam è prevista una catena di 100 cm inclusa. Amsterdam and Torpedo Amsterdam are supplied with a 100 cm (39 1/4") chain.					
Peso Weight		18 kg 40 lb	22 kg 48 lb	26 kg 57 lb	31 kg 68 lb
Lampadine Bulbs	N. Tipo W max. N. Type W max.	5 E14 60 E12 60	8 E14 60 E12 60	10 E14 60 E12 60	14 E14 60 E12 60
Dimmerabile Dimmable		D	D	D	D
Lampadine incluse Bulbs included					
Certificazioni Certification Marks					

Modelli e misure <i>Models and sizes</i>		Domo Amsterdam 7116	Torpedo Amsterdam 7142/09	Torpedo Amsterdam 7142/12	Torpedo Amsterdam 7142/18
*Per Amsterdam e Torpedo Amsterdam è prevista una catena di 100 cm inclusa. Amsterdam and Torpedo Amsterdam are supplied with a 100 cm (39 1/4") chain.					
Peso Weight		38 kg 85 lb	19 kg 42 lb	25 kg 55 lb	31 kg 68 lb
Lampadine Bulbs	N. Tipo W max. N. Type W max.	16 E14 60 E12 60	9 E14 60 E12 60	12 E14 60 E12 60	18 E14 60 E12 60
Dimmerabile Dimmable		D	D	D	D
Lampadine incluse Bulbs included					
Certificazioni Certification Marks					

Modelli e misure <i>Models and sizes</i>		Amsterdam 5562/18	Amsterdam 5562/24	Domo Amsterdam 7114	Domo Amsterdam 7115
*Per Amsterdam e Torpedo Amsterdam è prevista una catena di 100 cm inclusa. Amsterdam and Torpedo Amsterdam are supplied with a 100 cm (39 1/4") chain.					
Peso Weight		37 kg 81 lb	45 kg 99 lb	13 kg 28 lb	17 kg 37 lb
Lampadine Bulbs	N. Tipo W max. N. Type W max.	18 E14 60 E12 60	24 E14 60 E12 60	8 E14 60 E12 60	12 E14 60 E12 60
Dimmerabile Dimmable		D	D	D	D
Lampadine incluse Bulbs included					
Certificazioni Certification Marks					

Colori disponibili <i>Available colours</i>		*Per Amsterdam e Torpedo Amsterdam la finitura abbinata al colore OO è sempre OG. Per Domo Amsterdam la finitura abbinata al colore OO può essere CL, CN o OF. For Amsterdam and Torpedo Amsterdam the finishing matching colour OO is always OG. For Domo Amsterdam the finishings matching colour OO can be CL, CN or OF.				
CC Cristallo <i>Crystal</i>	IC Grigio <i>Grey</i>	EK Sabbia <i>Sand</i>	DK Oliva <i>Olive</i>	AK Blu Cadetto <i>Cadet Blue</i>	LQ Bluastro <i>Bluastro</i>	FK Indaco <i>Indigo</i>
VI Viola <i>Violet</i>	*OO Oro <i>Gold</i>	CK Pervinca <i>Pervinkle</i>	VI Viola <i>Violet</i>	*OO Oro <i>Gold</i>	CL Cromo Lucido <i>Polished Chrome</i>	*OG Oro Galvanizzato <i>Galvanized Gold</i>
Finiture Finishings	CL Cromo Lucido <i>Polished Chrome</i>	*OG Oro Galvanizzato <i>Galvanized Gold</i>	*CN Cromo Nero <i>Dark Chrome</i>	*OF Ottone Spazzolato Fine <i>Fine Brushed Brass</i>	BB Bianco <i>White</i>	NN Nero <i>Black</i>
Paralumi Shades	BB Bianco <i>White</i>	NN Nero <i>Black</i>	NO Nero Interno Oro <i>Black Inner Gold</i>	Paralumi Shades	Paralumi Shades	Paralumi Shades

BABYLON

Una collezione di lampadari con paralume, composta da quattro modelli, il cui segno distintivo è l'altezza ridotta (57 cm per il modello più piccolo fino ad un massimo di 80 cm), particolarmente adatta per illuminare ambienti in cui l'altezza non consentirebbe l'utilizzo di un lampadario tradizionale. Il paralume è in tessuto plissettato.

A collection of chandeliers with lampshades, of four models, whose distinctive sign is the reduced height (22 1/2" for the smallest model up to a maximum of 31 1/2"), particularly suitable to illuminate rooms whose height would not allow the use of a traditional chandelier. The lampshades are made of pleated fabric.



Modelli e misure Models and sizes	Babylon 5599/08	Babylon 5599/16	Babylon 5599/24	Babylon 5599/30
*Ogni modello prevede una catena di 100 cm inclusa. Every model is supplied with a 100 cm (39 1/4") chain.				
Peso Weight	9 kg 20 lb	14 kg 31 lb	20 kg 44 lb	24 kg 53 lb
Lampadine N. Tipo W max. Bulbs N. Type W max.	8 E14 60 E12 60	16 E14 60 E12 60	24 E14 60 E12 60	30 E14 60 E12 60
Dimmerabile Dimmable	D	D	D	D
Lampadine incluse Bulbs included				
Certificazioni Certification Marks				

Colori disponibili Available colours



CC
Cristallo
Crystal



IC
Grigio
Grey



EK
Sabbia
Sand



DK
Oliva
Olive



AK
Blu Cadetto
Cadet Blue



LQ
Bluastro
Bluastro



FK
Indaco
Indigo



CK
Pervinca
Periwinkle



VI
Viola
Violet



***OO**
Oro
Gold
*Solo OG
Only OG

Finiture Finishings



CN
Cromo Nero
Dark Chrome



***OG**
Oro Galvanizzato
Galvanized Gold
*Solo OO
Only OO

Paralumi Shades

Nastro Pongè
Pongee Ribbon

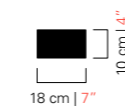

BB
Bianco
White



NN
Nero
Black

BAIKAL

Sulle orme di Taif, icona del design, Baikal ne riprende alcuni elementi distintivi come i pendagli in cristallo, i pastorali ritorti e i lunghi portalampade, ma con un corpo centrale più longilineo.

Following in the footsteps of Taif, a design icon, Baikal revisits some of its distinctive elements as the crystal pendants, the twisted pastorals and the long lamp holders, on a more tapered body.



Modelli e misure Models and sizes

*Ogni modello prevede una catena di 100 cm inclusa.
Every model is supplied with a 100 cm (39 1/4") chain.

	Baikal 5560/06	Baikal 5560/09	Baikal 5560/12	Baikal 5560/18
Peso Weight	18 kg 40 lb	27 kg 60 lb	35 kg 78 lb	64 kg 142 lb
Lampadine Bulbs	N. Tipo W max. 6 E14 60	N. Tipo W max. 9 E14 60	N. Tipo W max. 12 E14 60	N. Tipo W max. 18 E14 60
Dimmerabile Dimmable	D	D	D	D
Lampadine incluse Bulbs included				
Certificazioni Certification Marks				

Colori disponibili Available colours



CC
Cristallo
Crystal



BB
Bianco
White



IC
Grigio
Grey



EK
Sabbia
Sand



DK
Oliva
Olive



LQ
Bluastro
Bluastro



FK
Indaco
Indigo

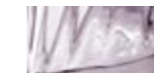

CK
Pervinca
Periwinkle



***OO**
Oro
Gold
*Solo OG
Only OG



NN
Nero
Black

Finiture Finishings



CL
Cromo Lucido
Polished Chrome



***OG**
Oro Galvanizzato
Galvanized Gold
*Solo OO
Only OO

BISSA BOBA

Angelo Barovier

Angelo Barovier, ispirandosi ad un lampadario veneziano degli archivi di Barovier&Toso, nel 1992 inventa un lampadario scomposto fatto di bracci che, come un serpente incantato, si ergono e si allontanano sinuosamente dal centro. Da qui il nome: "Bissa" è la parola che usano i veneziani per indicare un serpente.

Angelo Barovier, inspired by a Venetian chandelier from the Barovier&Toso archives, invented a decomposed chandelier made of arms which, like an enchanted snake, rise and sinuously move away from the center. Hence the name: "Bissa" is the word that Venetians use to indicate a snake.



Modelli e misure Models and sizes

*Ogni modello prevede una catena di 100 cm inclusa.
Every model is supplied with a 100 cm (39 1/4") chain.

	Bissa Boba 6753/08	Bissa Boba 6753/12	Bissa Boba 6753/16	Bissa Boba 6753/20
Peso Weight	9 kg 20 lb	14 kg 31 lb	18 kg 40 lb	23 kg 51 lb
Lampadine Bulbs	N. Tipo W max. 8 E14 60	N. Tipo W max. 12 E14 60	N. Tipo W max. 16 E14 60	N. Tipo W max. 20 E14 60
Dimmerabile Dimmable	D	D	D	D
Lampadine incluse Bulbs included				
Certificazioni Certification Marks				

Colori disponibili Available colours



CC
Cristallo
Crystal



IC
Grigio
Grey



EK
Sabbia
Sand



DK
Oliva
Olive



AK
Blu Cadetto
Cadet Blue



LQ
Bluastro
Bluastro



FK
Indaco
Indigo



CK
Pervinca
Periwinkle



VI
Viola
Violet



***OO**
Oro
Gold
*Solo OO
Only OO

Finiture Finishings



CL
Cromo Lucido
Polished Chrome



***OG**
Oro Galvanizzato
Galvanized Gold
*Solo OO
Only OO

DEGAS

Lampadari leggeri ed allungati dal disegno raffinato ed elegante. Spogliati delle tradizionali decorazioni floreali lasciano esposti i delicati bracci e rendono protagonista la luce soffusa donando calore ed atmosfera agli ambienti.

Graceful chandeliers that extend outward in a refined, elegant design. Stripped of the traditional floral decorations, their delicate arms are exposed, making the soft glow become the main feature that adds warmth and atmosphere to spaces.



Modelli e misure Models and sizes

*Ogni modello prevede una catena di 100 cm inclusa.
Every model is supplied with a 100 cm (39 1/4") chain.

	Degas 5554/06	Degas 5554/09	Degas 5554/12	Degas 5554/18
Peso Weight	9 kg 20 lb	10 kg 22 lb	16 kg 36 lb	24 kg 53 lb
Lampadine Bulbs	N. Tipo W max. 6 E14 60	N. Tipo W max. 9 E14 60	N. Tipo W max. 12 E14 60	N. Tipo W max. 18 E14 60
Dimmerabile Dimmable	D	D	D	D
Lampadine incluse Bulbs included				
Certificazioni Certification Marks				

Colori disponibili Available colours



CC
Cristallo
Crystal



IC
Grigio
Grey



EK
Sabbia
Sand



DK
Oliva
Olive



AK
Blu Cadetto
Cadet Blue



LQ
Bluastro
Bluastro



FK
Indaco
Indigo

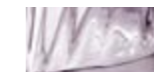

CK
Pervinca
Periwinkle



VI
Viola
Violet



***OO**
Oro
Gold
*Solo OO
Only OO

Finiture Finishings



CL
Cromo Lucido
Polished Chrome



***OG**
Oro Galvanizzato
Galvanized Gold
*Solo OO
Only OO

DHAMAR

I pinnacoli in colore "affogato" nel cristallo slanciano questo lampadario dalla struttura allargata e, insieme ai particolari pendagli e alle sfere sfaccettate, ne fanno un elemento decorativo importante.

Their colour "sunk" into the crystal pinnacles confer a graceful, slender look to this family of high-profile chandeliers. Meanwhile, the very unusual shapes of the pendants, complemented by the multifaceted spheres, conjure a compelling decorative effect.



Modelli e misure Models and sizes

*Ogni modello prevede una catena di 100 cm inclusa.
Every model is supplied with a 100 cm (39 1/4") chain.

	Dhamar 5596/06	Dhamar 5596/09	Dhamar 5596/12
	105 cm 41 1/4"	115 cm 45 1/4"	130 cm 51 1/4"
Peso Weight	20 kg 44 lb	27 kg 59 lb	32 kg 70 lb
Lampadine N. Tipo W max. Bulbs N. Type W max.	6 E14 60 E12 60	9 E14 60 E12 60	12 E14 60 E12 60
Dimmerabile Dimmable	D	D	D
Lampadine incluse Bulbs included			
Certificazioni Certification Marks			

Colori disponibili Available colours



CC
Cristallo
Crystal



BB
Bianco
White



IC
Grigio
Grey



EK
Sabbia
Sand



DK
Oliva
Olive



LQ
Bluastro
Bluastro



FK
Indaco
Indigo



CK
Perwinka
Perwinkle



***OO**
Oro
Gold
*Solo OO
Only OO



NN
Nero
Black

Finiture Finishings



CL
Cromo Lucido
Polished Chrome



***OG**
Oro Galvanizzato
Galvanized Gold
*Solo OO
Only OO

FAUVE

Elementi caratterizzanti di questa collezione sono le foglie sottili ed allungate sapientemente lavorate dai maestri vetrai nelle nostre fornaci. Oggetti dal design pulito che si inseriscono facilmente nei contesti più variegati riuscendo ad impreziosire un angolo o una stanza.

The characteristic features of this collection are the thin extending leaves created by master craftsmen in our furnaces. Objects with a clean design, to easily insert in a wide range of contexts, enhancing a corner or an entire room.



Modelli e misure Models and sizes

*Ogni modello prevede una catena di 100 cm inclusa.
Every model is supplied with a 100 cm (39 1/4") chain.

	Fauve 5306/06	Fauve 5306/08	Fauve 5306/12
Peso Weight	8 kg 18 lb	9 kg 20 lb	15 kg 33 lb
Lampadine Bulbs	N. Tipo W max. 6 E14 60	N. Tipo W max. 8 E14 60	N. Tipo W max. 12 E14 60
Dimmerabile Dimmable	D	D	D
Lampadine incluse Bulbs included			
Certificazioni Certification Marks			

Colori disponibili Available colours



CC
Cristallo
Crystal



IC
Grigio
Grey



EK
Sabbia
Sand



DK
Oliva
Olive



AK
Blu Cadetto
Cadet Blue



LQ
Bluastro
Bluastro



FK
Indaco
Indigo

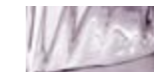

CK
Pervinca
Periwinkle



VI
Viola
Violet



***OO**
Oro
Gold
*Solo OO
Only OO

Finiture Finishings



CL
Cromo Lucido
Polished Chrome



***OG**
Oro Galvanizzato
Galvanized Gold
*Solo OO
Only OO

FEZ

Le foglie dorate e i pendagli a oliva caratterizzano questa famiglia di lampadari dalle altezze ridotte, ideali per i soffitti delle case moderne ma perfetti anche per i palazzi più lussuosi.

Gilded leaves and olive pendants feature in this family of chandeliers with reduced heights, ideal for the ceilings of modern houses but also perfect for more luxurious buildings.



Modelli e misure Models and sizes	Fez 5602/06	Fez 5602/08	Fez 5602/12	Fez 5602/18
*Ogni modello prevede una catena di 100 cm inclusa. Every model is supplied with a 100 cm (39 1/4") chain.				
Peso Weight	9 kg 20 lb	15 kg 33 lb	22 kg 49 lb	36 kg 80 lb
Lampadine N. Tipo W.max. Bulbs N. Type W.max.	6 E14 60 E12 60	8 E14 60 E12 60	12 E14 60 E12 60	18 E14 60 E12 60
Dimmerabile Dimmable	D	D	D	D
Lampadine incluse Bulbs included				
Certificazioni Certification Marks				

Colori disponibili Available colours



CC
Cristallo
Crystal



IC
Grigio
Grey



EK
Sabbia
Sand



DK
Oliva
Olive



AK
Blu Cadetto
Cadet Blue



LQ
Bluastro
Bluastro



FK
Indaco
Indigo

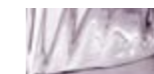

CK
Pervinca
Periwinkle



VI
Viola
Violet



***OO**
Oro
Gold
*Solo OO
Only OO

Finiture Finishings



CL
Cromo Lucido
Polished Chrome



***OG**
Oro Galvanizzato
Galvanized Gold
*Solo OO
Only OO

FLORIAN







I nostri archivi storici sono una miniera di ispirazioni: proprio da qui nasce Florian, un lampadario non circolare dalle linee retrò eppure così moderne, accentuate dai massicci paralumi in cristallo veneziano eseguiti con la tecnica del "rostrato", invenzione di Ercole Barovier che moltiplica i bagliori di luce e rende il lampadario un'opera di maestria unica.

Our historic archives provide a wealth of inspiration, and it was through them that the Florian design, a non-circular chandelier, was conceived. The lines of Florian are so retro but at the same time so contemporary, accentuated by massive Venetian crystal lampshades created using the "rostrato" technique invented by Ercole Barovier, intensifying the sparkle of the lights and making this chandelier a unique piece of craftsmanship.

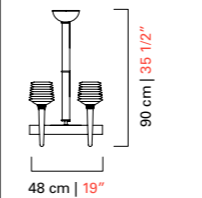
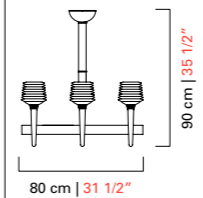
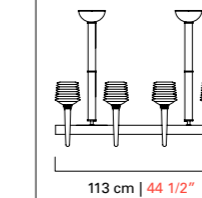
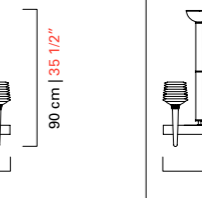
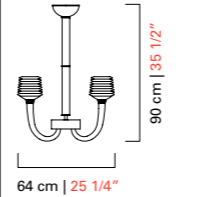
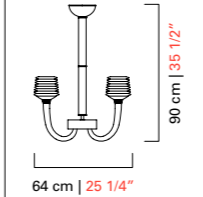
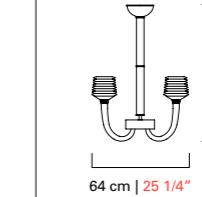

Modelli e misure Models and sizes

*Ogni modello prevede una catena di 100 cm inclusa.
Every model is supplied with a 100 cm (39 1/4") chain.

	Florian 5717/04	Florian 5717/06	Florian 5717/08	Florian 5717/10
				
				
Peso Weight	16 kg 35 lb	24 kg 53 lb	30 kg 66 lb	39 kg 86 lb
Lampadine Bulbs	N. Tipo W max. 4 E14 60	N. Tipo W max. 6 E14 60	N. Tipo W max. 8 E14 60	N. Tipo W max. 10 E14 60
Dimmerabile Dimmable	D	D	D	D
Lampadine incluse Bulbs included				
Certificazioni Certification Marks				

Colori disponibili Available colours



CC
Cristallo
Crystal

Finiture Finishings



CL
Cromo Lucido
Polished Chrome



CN
Cromo Nero
Dark Chrome



OF
Ottone
Spazzolato Fine
Fine Brushed Brass

IZMIR

Forme sinuose, pendagli in cristallo trasparente e bracci in cristallo veneziano ritorto: una combinazione ideale per esaltare la lucentezza e la matericità del vetro.

Sinuous forms, pendants in transparent crystal and arms in twisted Venetian crystal: an ideal combination to embellish the brilliance and substance of the glass.



Modelli e misure Models and sizes

*Ogni modello prevede una catena di 100 cm inclusa.
Every model is supplied with a 100 cm (39 1/4") chain.

	Izmir 5555/08	Izmir 5555/12	Izmir 5555/18	Izmir 5555/24
Peso Weight	18 kg 40 lb	28 kg 62 lb	40 kg 88 lb	52 kg 114 lb
Lampadine N. Tipo W max. Bulbs N. Type W max.	8 E14 60 E12 60	12 E14 60 E12 60	18 E14 60 E12 60	24 E14 60 E12 60
Dimmerabile Dimmable	D	D	D	D
Lampadine incluse Bulbs included				
Certificazioni Certification Marks				

Colori disponibili Available colours



CC
Cristallo
Crystal



IC
Grigio
Grey



EK
Sabbia
Sand



DK
Oliva
Olive



AK
Blu Cadetto
Cadet Blue



LQ
Bluastro
Bluastro



FK
Indaco
Indigo



CK
Pervinca
Periwinkle



VI
Viola
Violet



***OO**
Oro
Gold
*Solo OG
Only OG

Finiture Finishings



CL
Cromo Lucido
Polished Chrome





***OG**
Oro Galvanizzato
Galvanized Gold
*Solo OO
Only OO



MAGRITTE

La collezione Magritte è frutto di un lavoro concettuale che indaga l'idea di lampadario fino a ripensarla e destrutturarla. Ispirata al linguaggio surrealista, si presenta con un impianto scenografico ed elegante, a più livelli, come vuole la tradizione, ma nella realtà rivela un nuovo ed avanguardistico design. Il classico nucleo centrale a bracci lascia spazio ad un sistema a satelliti modulari, concepito per essere esteso in modo concentrico, come una nuvola di luce e vetro soffiato.

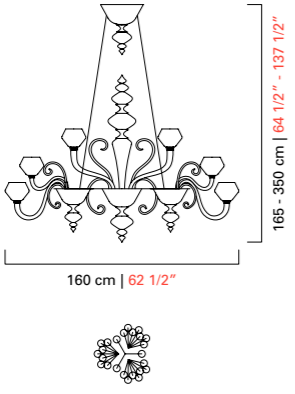
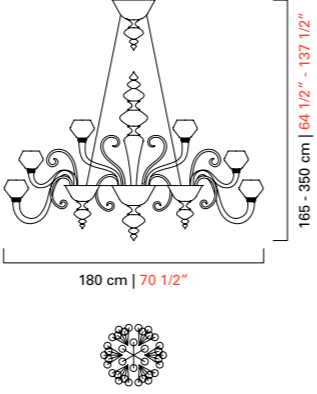
The Magritte collection is the result of a conceptual work that investigates the idea of a chandelier to the point of rethinking and deconstructing it. Inspired by the surrealist language, presents itself with a scenographic and elegant layout, on multiple levels, as tradition dictates, but in reality it reveals a new and avant-garde design. The classic central core with arms leaves room for a modular satellite system, conceived to be extended concentrically, like a cloud of light and blown glass.

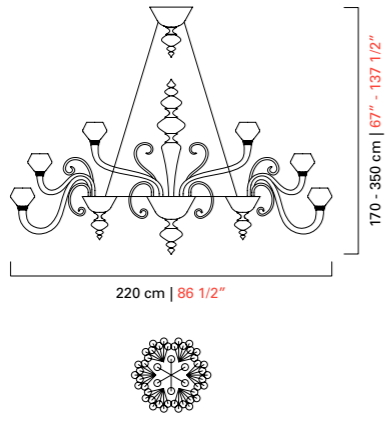

Modelli e misure <i>Models and sizes</i>		Magritte 5721/24	Magritte 5721/36
			
Peso Weight		55 kg 121 lb	80 kg 176 lb
Lampadine N. Tipo W max. Bulbs N. Type W max.		24 E14 60 E12 60	36 E14 60 E12 60
Dimmerabile Dimmable		D	D
Lampadine incluse Bulbs included			
Certificazioni Cerification Marks			

Modelli e misure <i>Models and sizes</i>		Magritte 5721/48
		
Peso Weight		110 kg 242 lb
Lampadine N. Tipo W max. Bulbs N. Type W max.		48 E14 60 E12 60
Dimmerabile Dimmable		D
Lampadine incluse Bulbs included		
Certificazioni Cerification Marks		

Colori disponibili
Available colours

CC
 Cristallo
Crystal

IC
 Grigio
Grey

EK
 Sabbia
Sand

DK
 Oliva
Olive

AK
 Blu Cadetto
Cadet Blue

LQ
 Bluastro
Bluastro

FK
 Indaco
Indigo

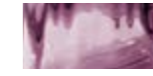
CK
 Pervinca
Periwinkle

VI
 Viola
Violet

***OO**
 Oro
Gold
 *Solo OG
Only OG
Finiture
Finishings

CL
 Cromo Lucido
Polished Chrome

***OG**
 Oro Galvanizzato
Galvanized Gold
 *Solo OO
Only OO

MARYLAND

I bracci molto sinuosi, il pendaglio a goccia, i paralumi eleganti: la collezione Maryland riporta il pensiero agli eleganti palazzi neoclassici del Nuovo Continente, dove imponenti lampadari fanno bella mostra di sé nelle stanze più importanti.

Sleek curves for the arms, drop pendants and elegant shades: Maryland collection recalls of Neoclassical buildings of the New World where majestic chandeliers are showcased in the most important rooms.

Domo Maryland design Franco Raggi

I bracci del lampadario Maryland, senza gravitare attorno al centro, si dispongono in orizzontale, a formare una prospettiva di paralumi bianchi o neri. Disponibile in tre misure, ha l'altezza regolabile.

The arms of the Maryland chandelier, without gravitating around the center, are arranged horizontally, to form a perspective of white or black lampshades. Available in three sizes, its height is adjustable.



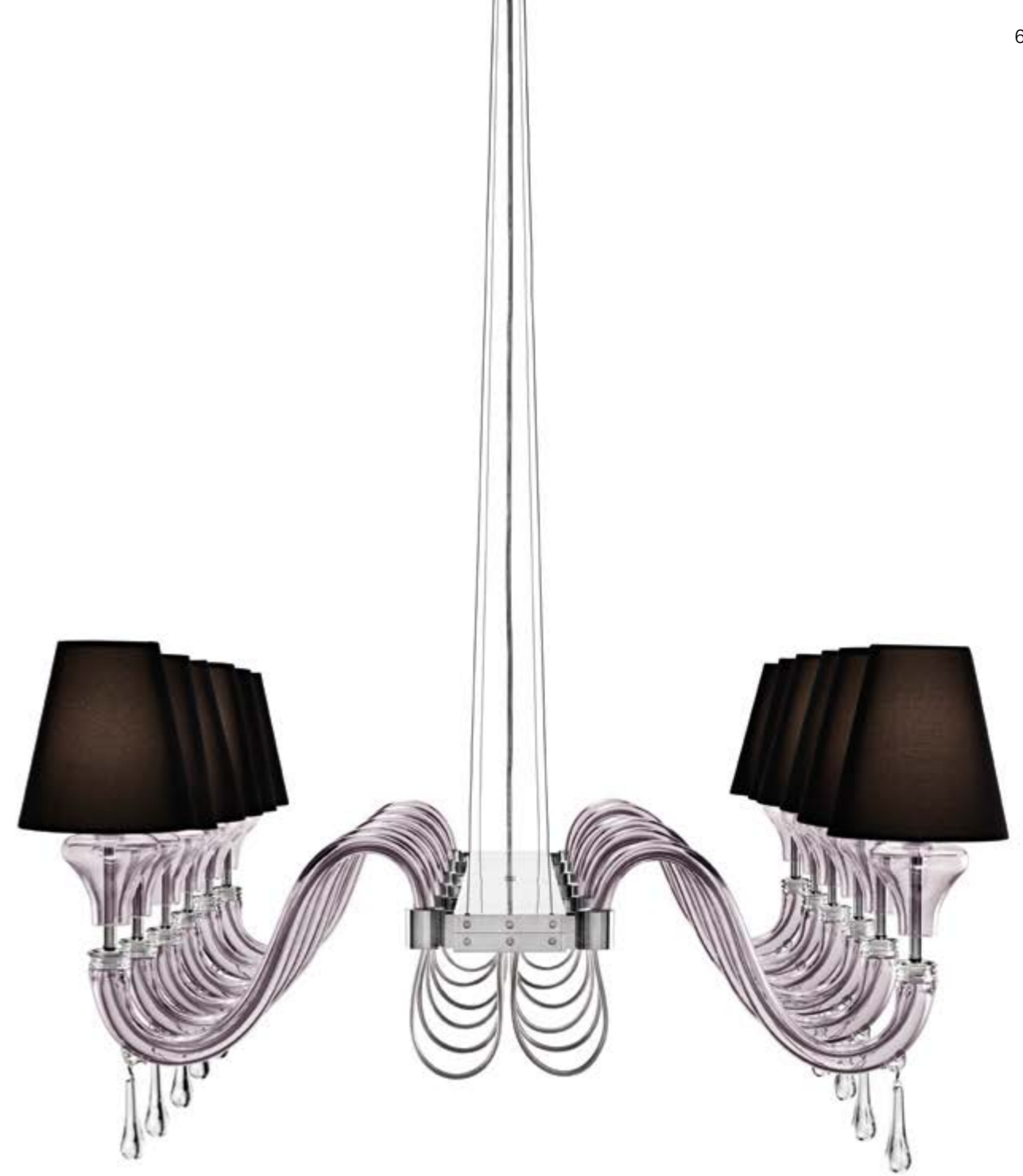

Modelli e misure <i>Models and sizes</i>		Maryland 5587/07	Maryland 5587/09	Maryland 5587/11	Maryland 5587/14
*Per Maryland è prevista una catena di 100 cm inclusa. Maryland is supplied with a 100 cm (39 1/4") chain.					
Peso Weight		8 kg 18 lb	12 kg 26 lb	15 kg 33 lb	19 kg 42 lb
Lampadine N. Tipo W max. Bulbs N. Type W max.		7 E14 60 E12 60	9 E14 60 E12 60	11 E14 60 E12 60	14 E14 60 E12 60
Dimmerabile Dimmable		D	D	D	D
Lampadine incluse Bulbs included					
Certificazioni Cerification Marks					

Modelli e misure <i>Models and sizes</i>		Domo Maryland 7038		Domo Maryland 7039	
Peso Weight		17 kg 37 lb		35 kg 77 lb	
Lampadine N. Tipo W max. Bulbs N. Type W max.		12 E14 60 E12 60		16 E14 60 E12 60	
Dimmerabile Dimmable		D		D	
Lampadine incluse Bulbs included					
Certificazioni Cerification Marks					

Modelli e misure <i>Models and sizes</i>		Maryland 5587/15	Maryland 5587/27	Domo Maryland 7037	
*Per Maryland è prevista una catena di 100 cm inclusa. Maryland is supplied with a 100 cm (39 1/4") chain.					
Peso Weight		21 kg 46 lb	34 kg 75 lb	13 kg 29 lb	
Lampadine N. Tipo W max. Bulbs N. Type W max.		15 E14 60 E12 60	27 E14 60 E12 60	8 E14 60 E12 60	
Dimmerabile Dimmable		D	D	D	
Lampadine incluse Bulbs included					
Certificazioni Cerification Marks					

Colori disponibili <i>Available colours</i>					
*Per Maryland la finitura abbinata al colore OO e sempre OG. Per Domo Maryland la finitura abbinata al colore OO può essere CL, CN o OF. For Maryland the finishing matching colour OO is always OG. For Domo Maryland the finishing matching colour OO can be CL, CN or OF.					
Finiture <i>Finishings</i>					
Paralumi Shades					
Esterno: Cotone External: Cotton					

MEKNES

Dall'archivio dei disegni storici di Barovier&Toso un lampadario della tradizione veneziana, ricco di elementi decorativi ispirati al mondo naturale. Fiori, foglie e boccioli fatti a mano rendono questo oggetto estremamente ricco e prezioso.

From the historical drawings archive of Barovier&Toso a chandelier from the Venetian tradition, full of decorative elements inspired by nature. Hand crafted flowers, leaves and buds make this object extremely rich and precious.



Modelli e misure Models and sizes

*Ogni modello prevede una catena di 100 cm inclusa.
Every model is supplied with a 100 cm (39 1/4") chain.

	Meknes 4797/06	Meknes 4797/08	Meknes 4797/12	Meknes 4797/18
Peso Weight	7 kg 15 lb	15 kg 33 lb	23 kg 51 lb	30 kg 66 lb
Lampadine Bulbs	N. Tipo W max. 6 E14 60	N. Tipo W max. 8 E14 60	N. Tipo W max. 12 E14 60	N. Tipo W max. 18 E14 60
Dimmerabile Dimmable	D	D	D	D
Lampadine incluse Bulbs included				
Certificazioni Certification Marks				

Colori disponibili Available colours



CC
Cristallo
Crystal



DO
Cristallo
Decoro Oro
Crystal Gold
Decoration



LQ
Cristallo
Decoro Bluastro
Crystal Bluastro
Decoration



***OO**
Oro
Gold
*Solo OO
Only OO

Finiture Finishings



CL
Cromo Lucido
Polished Chrome



***OG**
Oro Galvanizzato
Galvanized Gold
*Solo OO
Only OO

METROPOLIS

Metropolis si ispira alle atmosfere glamour ed ammalianti degli anni '20, capaci di rievocare quel vivace fermento che investì le arti visive, il design, l'architettura e la moda dell'epoca. Attingendo a quelle vibranti tendenze estetiche, che videro New York, Mosca, Berlino e Parigi trasformarsi in capitali del lusso, del divertimento e della bella vita. Una nuova collezione affascinante e raffinata, carica di una tensione espressiva intensa e sensuale.

Metropolis takes its cue from the glamorous, seductive atmospheres of the 1920s, drawing on the lively ferment in the visual arts, design, architecture and fashion in that period. Referencing the vibrant aesthetic trends that made New York, Moscow, Berlin and Paris into worldwide capitals of luxury, entertainment and lifestyle. A new collection fascinating and refined, charged with intense and sensual expressive energy.



Modelli e misure
Models and sizes

*Ogni modello prevede una catena di 100 cm inclusa.
 Every model is supplied with a 100 cm (39 1/4") chain.

	Metropolis 5720/06	Metropolis 5720/09	Metropolis 5720/12	Metropolis 5720/18
Peso Weight	15 kg 33 lb	18 kg 40 lb	25 kg 55 lb	37 kg 82 lb
Lampadine N. Tipo W max. Bulbs N. Type W max.	6+3 G9+Led 7+1,5 7+1,5	9+3 G9+Led 7+1,5 7+1,5	12+3 G9+Led 7+1,5 7+1,5	18+4 G9+Led 7+1,5 7+1,5
Dimmerabile Dimmable	D G9	D G9	D G9	D G9
Lampadine incluse Bulbs included	G9 Led + Led	G9 Led + Led	G9 Led + Led	G9 Led + Led
Certificazioni Certification Marks				

Colori disponibili
Available colours



CC
Cristallo
Crystal



IC
Grigio
Grey

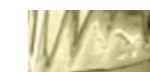

EK
Sabbia
Sand



DK
Oliva
Olive



AK
Blu Cadetto
Cadet Blue



LQ
Bluastro
Bluastro



FK
Indaco
Indigo



CK
Pervinca
Periwinkle



VI
Viola
Violet



OO
Oro
Gold

Finiture
Finishings

NU
Nickel Nero
Spazzolato
Brushed Black
Nickel



OJ
Oro Spazzolato
Brushed Gold

NEKHEL

Attingere alla nostra storia per farla rivivere nel mondo contemporaneo. Un'eredità preziosa che prende vita in questa collezione di lampadari, in diverse dimensioni, che esalta il gusto veneziano per i fiori e per le lavorazioni complesse.

Tapping into our heritage to bring it to a new life into the contemporary world. A precious legacy that comes alive in this collection of chandeliers, in different dimensions, that reflects the Venetian passion for flowers and complex handcrafted techniques.



Modelli e misure Models and sizes

*Ogni modello prevede una catena di 100 cm inclusa.
Every model is supplied with a 100 cm (39 1/4") chain.

Nekhel 5705/10

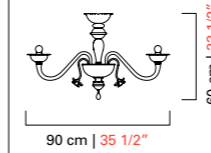

Nekhel 5705/12

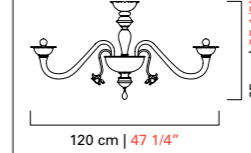

Nekhel 5705/16

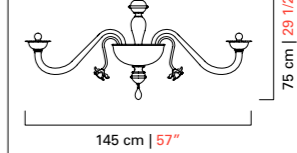

Peso Weight

14 kg
31 lb

19 kg
42 lb

30 kg
66 lb

Lampadine Bulbs

N.	Tipo	W max.
10	E14	60
	E12	60

N.	Tipo	W max.
12	E14	60
	E12	60

N.	Tipo	W max.
16	E14	60
	E12	60

Dimmerabile Dimmable

D

D

D

Lampadine incluse Bulbs included

Certificazioni Certification Marks



Colori disponibili Available colours



CC
Cristallo
Crystal



DO
Cristallo
Decoro Oro
Crystal Gold
Decoration



LO
Cristallo
Decoro Bluastro
Crystal Bluastro
Decoration



***OO**
Oro
Gold
*Solo OG
Only OG

Finiture Finishings



CL
Cromo Lucido
Polished Chrome



***OG**
Oro Galvanizzato
Galvanized Gold
*Solo OO
Only OO

NEVADA

Arredare con un lampadario in cristallo veneziano di questa collezione significa donare eleganza e carattere agli ambienti, anche se di stili differenti. L'elemento caratterizzante sono i bracci rettilinei quasi privi di curvature dai quali pendono esili e delicati pendagli a forma di goccia.

Decorating with a chandelier in Venetian crystal from this collection means adding elegance and character to spaces, even when their styles differ. The rectilinear arms, almost without curvature, are the characteristic feature, supporting slender, delicate dewdrop pendants.

Domo Nevada design Franco Raggi

Un'inversione dei poli, uno stravolgimento di un concetto assodato eppure così malleabile e reinterpretabile: un cerchio che si fa rettangolo, una rivisitazione della tradizione. Elegante scomposizione del lampadario classico.

In a reversal of expectations, the usual preconceptions are turned upside down and prove to be malleable and open to reinvention: the circle becomes a rectangle, in a reworking of tradition. An elegant decomposition of the classic chandelier.

Torpedo Nevada

Questa versione si caratterizza per l'altezza - che può arrivare fino a 285 cm - e per la sua snellezza. Adatto per grandi reception o scenografiche scale, è disponibile con due, tre o quattro livelli.

This version is characterized by its height - which can reach up to 112" - and by its slenderness. Suitable for large reception areas or scenic staircases, it is available with two, three or four levels.











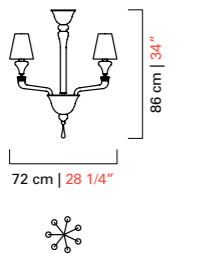
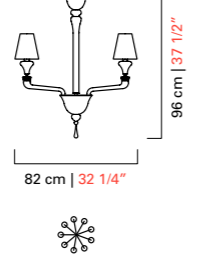
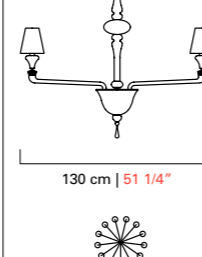
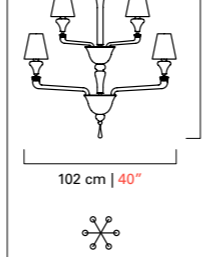

Domo Nevada 7031



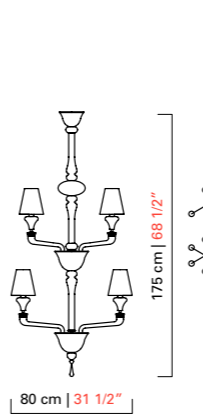
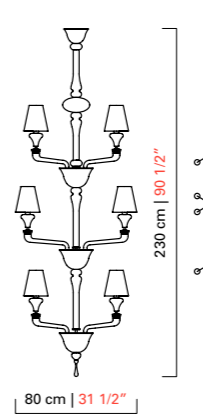
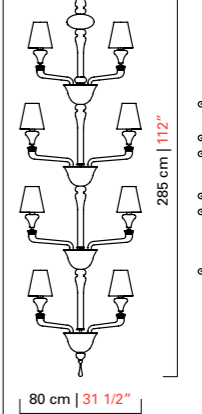





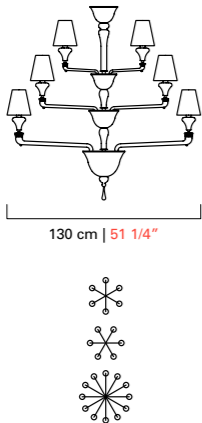
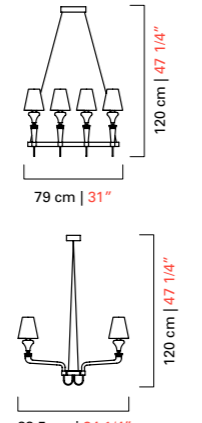
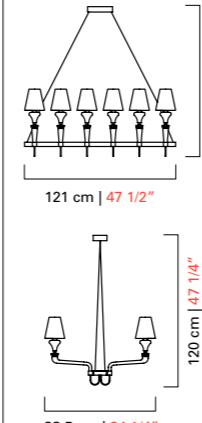
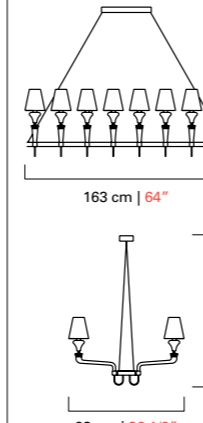
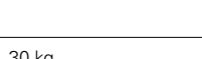
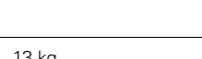
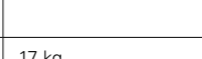
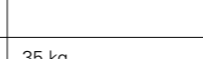









Torpedo Nevada 7141/12

Modelli e misure <i>Models and sizes</i>		Nevada 5549/07	Nevada 5549/09	Nevada 5549/13	Nevada 5549/15
*Per Nevada e Torpedo Nevada è prevista una catena di 100 cm inclusa. Nevada and Torpedo Nevada are supplied with a 100 cm (39 1/4") chain.					
Peso Weight		9 kg 20 lb	12 kg 26 lb	20 kg 44 lb	19 kg 42 lb
Lampadine Bulbs	N. Tipo W max. N. Type W max.	7 E14 60 E12 60	9 E14 60 E12 60	13 E14 60 E12 60	15 E14 60 E12 60
Dimmerabile Dimmable		D	D	D	D
Lampadine incluse Bulbs included					
Certificazioni Certification Marks					

Modelli e misure <i>Models and sizes</i>		Torpedo Nevada 7141/09	Torpedo Nevada 7141/12	Torpedo Nevada 7141/18
*Per Nevada e Torpedo Nevada è prevista una catena di 100 cm inclusa. Nevada and Torpedo Nevada are supplied with a 100 cm (39 1/4") chain.				
Peso Weight		16 kg 35 lb	22 kg 48 lb	28 kg 62 lb
Lampadine Bulbs	N. Tipo W max. N. Type W max.	9 E14 60 E12 60	12 E14 60 E12 60	18 E14 60 E12 60
Dimmerabile Dimmable		D	D	D
Lampadine incluse Bulbs included				
Certificazioni Certification Marks				

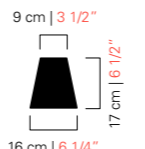
Modelli e misure <i>Models and sizes</i>		Nevada 5549/24	Domo Nevada 7031	Domo Nevada 7032	Domo Nevada 7033
*Per Nevada e Torpedo Nevada è prevista una catena di 100 cm inclusa. Nevada and Torpedo Nevada are supplied with a 100 cm (39 1/4") chain.					
Peso Weight		30 kg 66 lb	13 kg 29 lb	17 kg 37 lb	35 kg 77 lb
Lampadine Bulbs	N. Tipo W max. N. Type W max.	24 E14 60 E12 60	8 E14 60 E12 60	12 E14 60 E12 60	16 E14 60 E12 60
Dimmerabile Dimmable		D	D	D	D
Lampadine incluse Bulbs included					
Certificazioni Certification Marks					

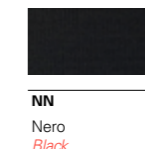
Colori disponibili <i>Available colours</i>						
*Per Nevada e Torpedo Nevada la finitura abbinata al colore OO è sempre OG. Per Domo Nevada la finitura abbinata al colore OO può essere CL, CN o OF. For Nevada and Torpedo Nevada the finishing matching colour OO is always OG. For Domo Nevada the finishing matching colour OO can be CL, CN or OF.		CC Cristallo <i>Crystal</i>	IC Grigio <i>Grey</i>	EK Sabbia <i>Sand</i>	DK Oliva <i>Olive</i>	AK Blu Cadetto <i>Cadet Blue</i>
						
		LQ Bluastro <i>Bluastro</i>	FK Indaco <i>Indigo</i>	CK Perivinka <i>Perivinka</i>	VI Viola <i>Violet</i>	*OO Oro <i>Gold</i>
Finiture <i>Finishings</i>						
		CL Cromo Lucido <i>Polished Chrome</i>	*OG Oro Galvanizzato <i>Galvanized Gold</i> *Solo OO Nevada e OO Torpedo Nevada <i>Only OO Nevada and OO Torpedo Nevada</i>	*CN Cromo Nero <i>Dark Chrome</i> *Solo Domo Nevada <i>Only Domo Nevada</i>	*OF Ottone Spazzolato Fine <i>Fine Brushed Brass</i> *Solo Domo Nevada <i>Only Domo Nevada</i>	
Paralumi <i>Shades</i>						
Esterno: Cotone <i>External: Cotton</i>		BB Bianco <i>White</i>	NN Nero <i>Black</i>	NO Nero Interno Oro <i>Black Inner Gold</i>		

ODILE





Lampadari in cristallo veneziano realizzati a mano dai nostri esperti maestri vetrai. Queste raffinate creazioni donano eleganza e classe ad ogni tipo di ambiente, sia classico che moderno, rappresentano l'ornamento di lusso che abbina la tradizione antica al design più moderno: vere opere d'arte per illuminare al meglio gli spazi.

Chandeliers in Venetian crystal handcrafted by our expert master glassmakers. These refined creations add elegance and class to any decor, classic or modern. They represent an approach to luxury that combines an age-old tradition with the most advanced design: true works of art to brighten all kinds of spaces.

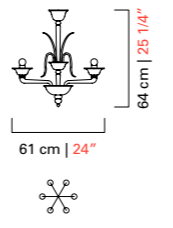
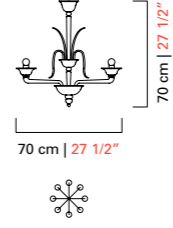
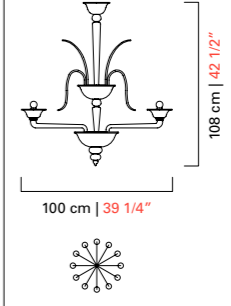

Modelli e misure Models and sizes

*Ogni modello prevede una catena di 100 cm inclusa.
Every model is supplied with a 100 cm (39 1/4") chain.

	Odile 5307/06	Odile 5307/08	Odile 5307/12
			
Peso Weight	7 kg 15 lb	8 kg 18 lb	13 kg 29 lb
Lampadine Bulbs	N. 6 Tipo E14 W max. 60	N. 8 Tipo E14 W max. 60	N. 12 Tipo E14 W max. 60
Dimmerabile Dimmable	D	D	D
Lampadine incluse Bulbs included			
Certificazioni Certification Marks			

Colori disponibili Available colours



CC
Cristallo
Crystal



IC
Grigio
Grey



EK
Sabbia
Sand



DK
Oliva
Olive



AK
Blu Cadetto
Cadet Blue



LQ
Bluastro
Bluastro



FK
Indaco
Indigo



CK
Pervinca
Periwinkle

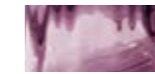

VI
Viola
Violet



***OO**
Oro
Gold
*Solo OG
Only OG

Finiture Finishings



CL
Cromo Lucido
Polished Chrome



***OG**
Oro Galvanizzato
Galvanized Gold
*Solo OO
Only OO

PALLADIANO

Simmetria, ordine, perfezione ed eleganza sono le muse ispiratrici di questa collezione. Un omaggio alla razionalità e all'equilibrio delle opere del Palladio ed ai valori dell'architettura formale classica. Anche la scelta della palette cromatica con i suoi colori pieni, non trasparenti, è una celebrazione della matericità e del volume dell'oggetto che si trasforma quasi, esso stesso, in una piccola architettura.

Symmetry, order, perfection and elegance are the muses behind this collection. A tribute to the rationality and balance of the works of Palladio, and the values of formal classical architecture. The selection of colours, in full, non-transparent hues, is a celebration of the material and volume of the object, which is transformed almost into a small work of architecture.

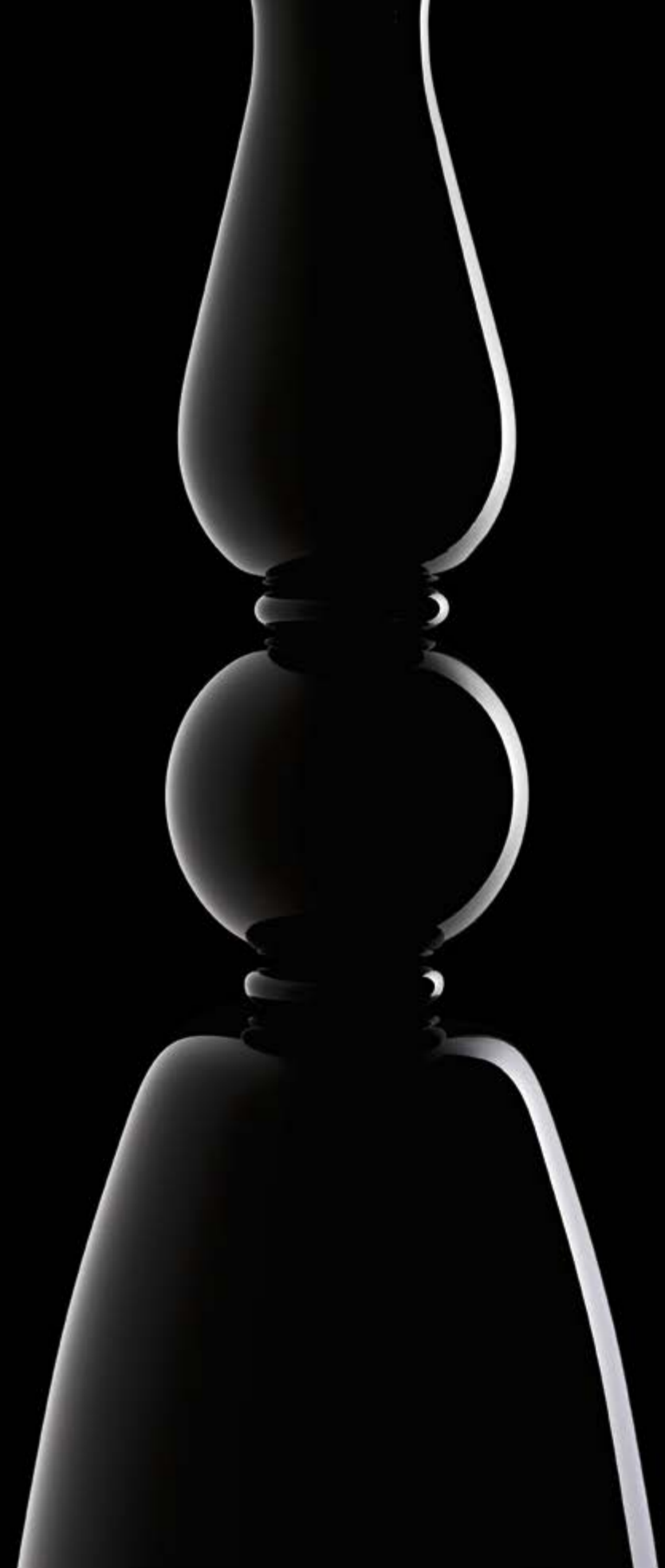

Modelli e misure
Models and sizes

*Ogni modello prevede una catena di 100 cm inclusa.
Every model is supplied with a 100 cm (39 1/4") chain.

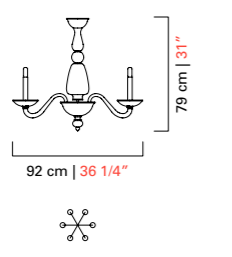
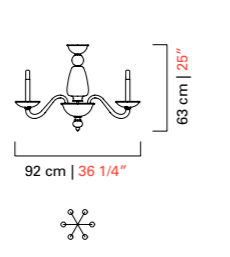
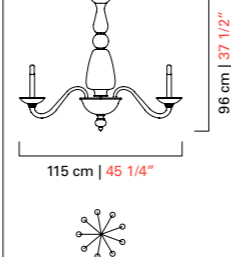
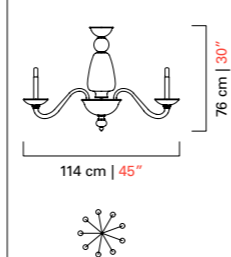
	Palladiano 5600/06	Palladiano 5600/06/B	Palladiano 5600/09	Palladiano 5600/09/B
				
Peso Weight	12 kg 26 lb	11 kg 24 lb	16 kg 35 lb	15 kg 33 lb
Lampadine N. Tipo W max. Bulbs N. Type W max.	6 E14 60 E12 60	6 E14 60 E12 60	9 E14 60 E12 60	9 E14 60 E12 60
Dimmerabile Dimmable	D	D	D	D
Lampadine incluse Bulbs included				
Certificazioni Cerification Marks				

Colori disponibili
Available colours



CC
Cristallo
Crystal



BB
Bianco
White



NN
Nero
Black

Finiture
Finishings



CL
Cromo Lucido
Polished Chrome

Modelli e misure
Models and sizes

*Ogni modello prevede una catena di 100 cm inclusa.
Every model is supplied with a 100 cm (39 1/4") chain.

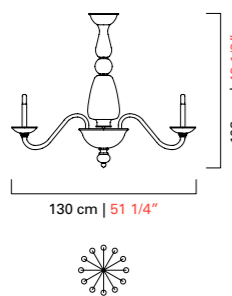
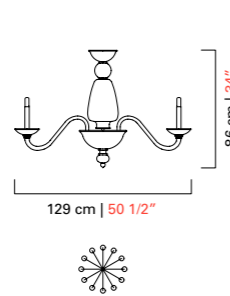
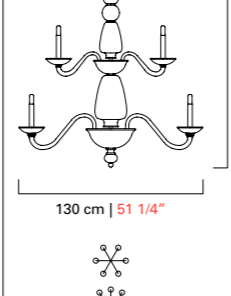
	Palladiano 5600/12	Palladiano 5600/12/B	Palladiano 5600/18
			
Peso Weight	20 kg 44 lb	18 kg 40 lb	30 kg 66 lb
Lampadine N. Tipo W max. Bulbs N. Type W max.	12 E14 60 E12 60	12 E14 60 E12 60	18 E14 60 E12 60
Dimmerabile Dimmable	D	D	D
Lampadine incluse Bulbs included			
Certificazioni Cerification Marks			

PIGALLE





Tradizione ed innovazione si fondono in questa collezione ispirata alla Belle Époque. Si caratterizza per eleganza e linee sinuose senza risultare eccessiva ed ostentata. Eloquente per raffinatezza e grazia alterna linee semplici, dettagli curvi e lavorazioni tradizionali. I quattro lampadari che compongono la famiglia sono caratterizzati da un corpo centrale molto ricco, con elementi dalle forme morbide e sinuose lavorati con tecniche diverse. È circondato da bracci slanciati su cui poggiano i diffusori bianchi.

Tradition and innovation blend in this collection inspired by the Belle Époque. It stands out for its elegant, sinuous lines, without ever seeming excessive or ostentatious. With its eloquent refinement and grace, it mixes simple lines, curved details and traditional workmanship. A family of four chandeliers characterized by a lavish central body with soft-shape elements that are wrought using different techniques. It is surrounded by slender arms upon which the white diffusers rest.

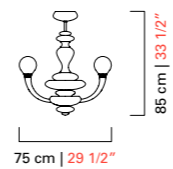
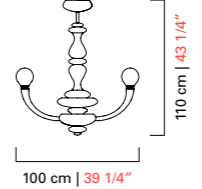
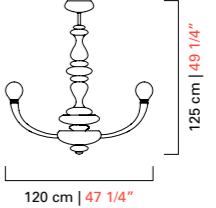
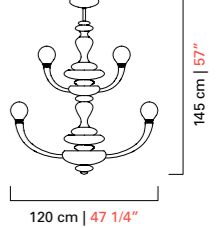

Modelli e misure Models and sizes

*Ogni modello prevede una catena di 100 cm inclusa.
Every model is supplied with a 100 cm (39 1/4") chain.

	Pigalle 5680/06	Pigalle 5680/09	Pigalle 5680/12	Pigalle 5680/18
				
Peso Weight	18 kg 40 lb	28 kg 62 lb	38 kg 84 lb	50 kg 110 lb
Lampadine N. Tipo W max. Bulbs N. Type W max.	6+1 Led 8,4+8,4 8,4+8,4	9+1 Led 8,4+8,4 8,4+8,4	12+1 Led 8,4+8,4 8,4+8,4	18+1 Led 8,4+8,4 8,4+8,4
Dimmerabile Dimmable				
Lampadine incluse Bulbs included	Led	Led	Led	Led
Certificazioni Cerification Marks				

Colori disponibili Available colours



CC
Cristallo
Crystal



OO
Oro
Gold

Finiture Finishings



CL
Cromo Lucido
Polished Chrome



CN
Cromo Nero
Dark Chrome



OJ
Oro Spazzolato
Brushed Gold

PREMIÈRE DAME

L'opulenza delle forme e dei dettagli rifugge nei pendagli di una collezione maestosa, degna delle più importanti, sontuose e ricercate dimore francesi. Con una ricchezza decorativa molto sofisticata, questa collezione si caratterizza per le diverse lavorazioni del cristallo veneziano e dei pendagli di fattura originale.

The opulence of shapes and details radiates in the pendants of a majestic collection, worthy of the most important, sumptuous and refined French residences. With its richly decorated and sophisticated design this collection is characterized by different Venetian crystal craftworks and an original pendants fabrication.

Modelli e misure Models and sizes

*Ogni modello prevede una catena di 100 cm inclusa.
Every model is supplied with a 100 cm (39 1/4") chain.

	Première Dame 5696/12/B	Première Dame 5696/12/A	Première Dame 5696/16	Première Dame 5696/24

Peso Weight	17 kg 37 lb	19 kg 42 lb	25 kg 55 lb	38 kg 84 lb
Lampadine N. Tipo W max. Bulbs N. Type W max.	12 E14 60 E12 60	12 E14 60 E12 60	16 E14 60 E12 60	24 E14 60 E12 60
Dimmerabile Dimmable	D	D	D	D
Lampadine incluse Bulbs included				
Certificazioni Certification Marks				

Colori disponibili Available colours

CC Cristallo Crystal	BB Bianco White	IC Grigio Grey	EK Sabbia Sand	DK Oliva Olive
LQ Bluastro Bluastro	FK Indaco Indigo	CK Pervinca Periwinkle	*OO Oro Gold *Solo OG Only OG	NN Nero Black

Finiture Finishings

CL Cromo Lucido Polished Chrome	*OG Oro Galvanizzato Galvanized Gold *Solo OO Only OO

Paralumi Shades

Nastro Pongè
Pongee Ribbon

BB Bianco White	NN Nero Black



PRÉSIDENT

Un lampadario a bracci iconico per antonomasia che mette in risalto la meticolosa eleganza della lavorazione artigianale. Prismi cesellati, pendenti scintillanti e coppette decorate lo rendono un elemento d'arredo davvero unico in cui il cristallo veneziano rivela il suo splendore scultoreo.

An iconic chandelier with arms par excellence that proudly displays its painstaking workmanship and elegance. Chiseled prisms, sparkling pendants and decorated cups make this a truly unique decor feature, in which Venetian crystal reveals its sculptural splendour.



Modelli e misure
Models and sizes

*Ogni modello prevede una catena di 100 cm inclusa.
Every model is supplied with a 100 cm (39 1/4") chain.

	Président 5695/12	Président 5695/14	Président 5695/18/A	Président 5695/18/B
Peso Weight	17 kg 37 lb	24 kg 53 lb	29 kg 64 lb	34 kg 75 lb
Lampadine N. Tipo W max. Bulbs N. Type W max.	12 E14 60 E12 60	14 E14 60 E12 60	18 E14 60 E12 60	18 E14 60 E12 60
Dimmerabile Dimmable	D	D	D	D
Lampadine incluse Bulbs included				
Certificazioni Cerification Marks				

Modelli e misure
Models and sizes

*Ogni modello prevede una catena di 100 cm inclusa.
Every model is supplied with a 100 cm (39 1/4") chain.

	Président 5695/24	Président 5695/36
Peso Weight	42 kg 92 lb	45 kg 99 lb
Lampadine N. Tipo W max. Bulbs N. Type W max.	24 E14 60 E12 60	36 E14 60 E12 60
Dimmerabile Dimmable	D	D
Lampadine incluse Bulbs included		
Certificazioni Cerification Marks		

Colori disponibili
Available colours

 CC Cristallo <i>Crystal</i>	 BB Bianco <i>White</i>	 IC Grigio <i>Grey</i>	 EK Sabbia <i>Sand</i>	 DK Oliva <i>Olive</i>
 LQ Bluastro <i>Bluastro</i>	 FK Indaco <i>Indigo</i>	 CK Pervinca <i>Perwinkle</i>	 *OO Oro <i>Gold</i> *Solo OG <i>Only OG</i>	 NN Nero <i>Black</i>

Finiture
Finishings

 CL Cromo Lucido <i>Polished Chrome</i>	 *OG Oro Galvanizzato <i>Galvanized Gold</i> *Solo OO <i>Only OO</i>
---	--

Paralumi
Shades

Esterno: Cotone
External: Cotton

	 BB Bianco <i>White</i>	 NN Nero <i>Black</i>	 NO Nero Interno Oro <i>Black Inner Gold</i>

QUADRI





Come in un tulipano gli esili bracci sembrano voler nascondere alla vista i riccioluti pistilli che, grazie alla loro particolare lavorazione ritorta di secolare tradizione, rifrangono la luce proiettando ombre complesse.

Like in a tulip the delicate stems seem to protect the curled pistils which, thanks to the centuries-old crafting technique, refract light generating shadows with a complex texture.

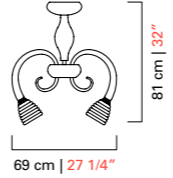
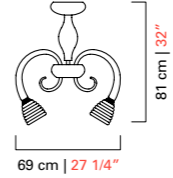
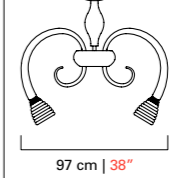
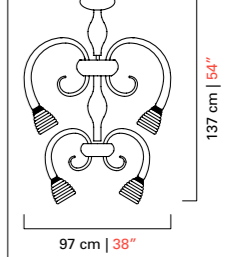

Modelli e misure Models and sizes

*Ogni modello prevede una catena di 100 cm inclusa.
Every model is supplied with a 100 cm (39 1/4") chain.

	Quadri 5718/03	Quadri 5718/06/A	Quadri 5718/06/B	Quadri 5718/12
				
Peso Weight	13 kg 29 lb	20 kg 44 lb	23 kg 51 lb	42 kg 92 lb
Lampadine Bulbs	N. Tipo W max. 3 E14 60	N. Tipo W max. 6 E14 60	N. Tipo W max. 6 E14 60	N. Tipo W max. 12 E14 60
Dimmerabile Dimmable	D	D	D	D
Lampadine incluse Bulbs included				
Certificazioni Certification Marks				

Colori disponibili Available colours



CC
Cristallo
Crystal



IC
Grigio
Grey



EK
Sabbia
Sand



DK
Oliva
Olive



AK
Blu Cadetto
Cadet Blue



LQ
Bluastro
Bluastro



FK
Indaco
Indigo



CK
Pervinca
Perwinkle



VI
Viola
Violet



OO
Oro
Gold

Finiture Finishings



CL
Cromo Lucido
Polished Chrome

RABAT

Una collezione classica, che utilizza molti degli stilemi della tradizione veneziana. In particolare, le "morise", decorazioni ondulate eseguite applicando a caldo un cordoncino di vetro pizzicato con le "borselle" (pinze) da "pissegar" (pizzicare) che consentono di ottenere una superficie che sembra un merletto.

A classical collection that features many of the stylistic elements of the Venetian tradition. In particular the "morise", wavy decorations executed by applying a hot crystal ribbon and then pinching it with the "borselle" (pincers) to "pissegar" (pinching) to obtain a texture that looks like a lace.



Modelli e misure Models and sizes

*Ogni modello prevede una catena di 100 cm inclusa.
Every model is supplied with a 100 cm (39 1/4") chain.

	Rabat 4513/05	Rabat 4513/08	Rabat 4513/12
Peso Weight	7 kg 15 lb	15 kg 33 lb	20 kg 44 lb
Lampadine Bulbs	N. Tipo W max. 5 E14 60 E12 60	N. Tipo W max. 8 E14 60 E12 60	N. Tipo W max. 12 E14 60 E12 60
Dimmerabile Dimmable	D	D	D
Lampadine incluse Bulbs included			
Certificazioni Certification Marks			

Colori disponibili Available colours



CC
Cristallo
Crystal



DO
Cristallo
Decoro Oro
Crystal Gold
Decoration



LQ
Cristallo
Decoro Bluastro
Crystal Bluastro
Decoration



***OO**
Oro
Gold
*Solo OG
Only OG

Finiture Finishings



CL
Cromo Lucido
Polished Chrome



***OG**
Oro Galvanizzato
Galvanized Gold
*Solo OO
Only OO

RAN ROUND

Trasparenza e leggerezza. Grazie ai bracci dalle ampie curvature, alle ogive soffiate in serie e ad i pendagli a goccia di grandi dimensioni i lampadari acquisiscono una straordinaria lievità e delicatezza. Questa è l'unica collezione che prevede anche versioni a pianta ellittica particolarmente adatte ad essere posizionate in corrispondenza di tavoli da pranzo rettangolari.

Transparency and lightness. Thanks to the wide curves of the arms, the mouth blown ogives aligned in series and the extra size drop-shaped pendants, the chandeliers appear extremely slight and delicate. This is the only collection that has elliptical versions that perfectly fit on top of rectangular dining tables.



Modelli e misure
Models and sizes

*Ogni modello prevede una catena di 100 cm inclusa.
Every model is supplied with a 100 cm (39 1/4") chain.

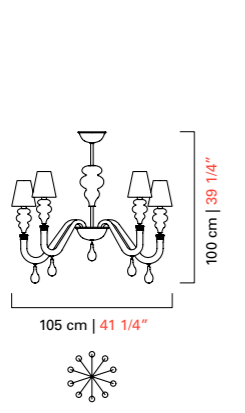
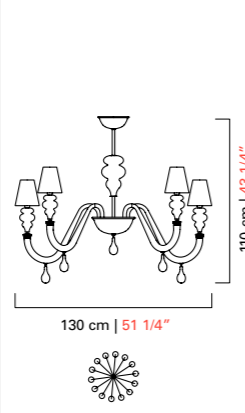
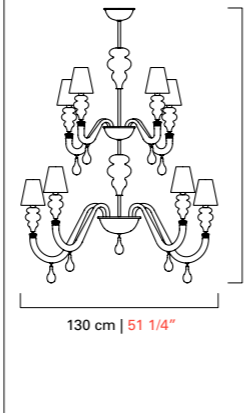
	Ran Round 7176/10	Ran Round 7176/14	Ran Round 7176/18
			
Peso Weight	15 kg 33 lb	21 kg 46 lb	27 kg 60 lb
Lampadine N. Tipo W max. Bulbs N. Type W max.	10 E14 60 E12 60	14 E14 60 E12 60	18 E14 60 E12 60
Dimmerabile Dimmable	D	D	D
Lampadine incluse Bulbs included			
Certificazioni Cerification Marks			

Modelli e misure
Models and sizes

*Ogni modello prevede una catena di 100 cm inclusa.
Every model is supplied with a 100 cm (39 1/4") chain.

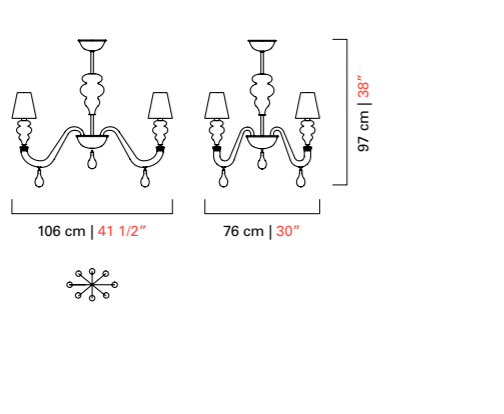
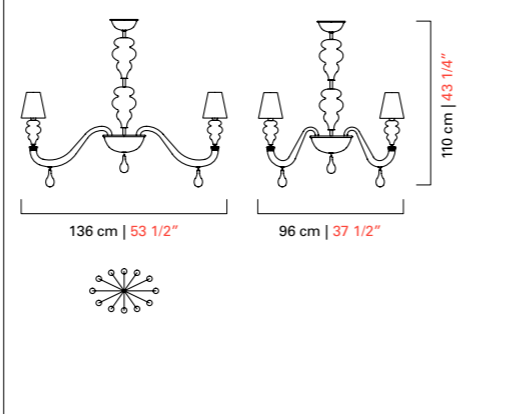
	Ran Round 7177/08	Ran Round 7177/12
		
Peso Weight	15 kg 33 lb	20 kg 44 lb
Lampadine N. Tipo W max. Bulbs N. Type W max.	8 E14 60 E12 60	12 E14 60 E12 60
Dimmerabile Dimmable	D	D
Lampadine incluse Bulbs included		
Certificazioni Cerification Marks		

Modelli e misure
Models and sizes

*Ogni modello prevede una catena di 100 cm inclusa.
Every model is supplied with a 100 cm (39 1/4") chain.

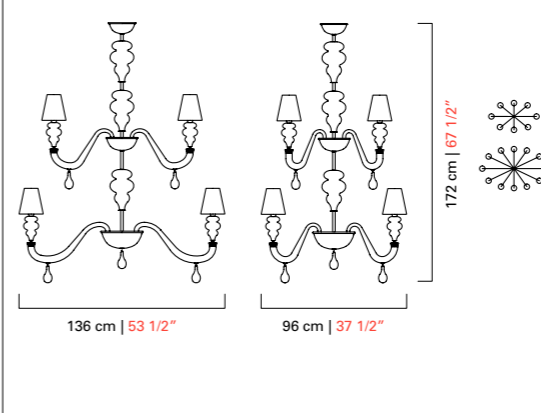
	Ran Round 7177/20
	
Peso Weight	35 kg 77 lb
Lampadine N. Tipo W max. Bulbs N. Type W max.	20 E14 60 E12 60
Dimmerabile Dimmable	D
Lampadine incluse Bulbs included	
Certificazioni Cerification Marks	

Colori disponibili
Available colours

CC Cristallo Crystal	IC Grigio Grey	EK Sabbia Sand	DK Oliva Olive	AK Blu Cadetto Cadet Blue
LQ Bluastro Bluastro	FK Indaco Indigo	CK Pervinca Periwinkle	VI Viola Violet	*OO Oro Gold *Solo OG *Solo OG Only OG

Finiture
Finishings

CL Cromo Lucido Polished Chrome	*OG Oro Galvanizzato Galvanized Gold *Solo OO *Solo OO Only OO

Paralumi
Shades

Esterno: Cotone
External: Cotton

			
BB Bianco White	NN Nero Black	NO Nero Interno Oro Black Inner Gold	

REDON

Una collezione della tradizione muranese, caratterizzata da un notevole sviluppo verticale. Attraverso la sovrapposizione di corone di foglie delicatamente arricciate alle estremità e livelli di bracci di lunghezze diverse si ottiene un effetto di grande dinamicità.

From the traditional Muranese design here comes a collection with a remarkable vertical flow. By overlapping crowns made with leaves gently curled at their edges and levels of arms with different dimensions the result is an effect of great dynamism.



Modelli e misure Models and sizes

*Ogni modello prevede una catena di 100 cm inclusa.
Every model is supplied with a 100 cm (39 1/4") chain.

	Redon 5308/06	Redon 5308/12	Redon 5308/18	Redon 5308/24
Peso Weight	12 kg 26 lb	35 kg 77 lb	45 kg 99 lb	65 kg 143 lb
Lampadine Bulbs	N. Tipo W max. 6 E14 60	N. Tipo W max. 12 E14 60	N. Tipo W max. 18 E14 60	N. Tipo W max. 24 E14 60
Dimmerabile Dimmable	D	D	D	D
Lampadine incluse Bulbs included				
Certificazioni Certification Marks				

Colori disponibili Available colours



CC
Cristallo
Crystal



IC
Grigio
Grey



DK
Oliva
Olive



AK
Blu Cadetto
Cadet Blue



LQ
Bluastro
Bluastro



FK
Indaco
Indigo



CK
Pervinca
Periwinkle



VI
Viola
Violet



***OO**
Oro
Gold
*Solo OG
Only OG

Finiture Finishings



CL
Cromo Lucido
Polished Chrome



***OG**
Oro Galvanizzato
Galvanized Gold
*Solo OO
Only OO

RIYADH

Di grande impatto scenografico, la famiglia di lampadari Riyadh è ricca di elementi decorativi e lavorazioni a mano complesse. Un tributo al sapiente lavoro dei nostri esperti maestri vetrai. Foglie, pendagli, bossette e coppette si susseguono incessantemente in un intreccio quasi caotico per dar vita ad un disegno perfetto.

Making a highly dramatic impact, the family of Riyadh chandeliers is rich of decorative elements and complex handcrafted techniques. A tribute to our expert glass masters' skills. Leaves, pendants, "bossette" and cups come into an intricate, almost chaotic, succession to give birth to a perfect design.



Modelli e misure Models and sizes

*Ogni modello prevede una catena di 100 cm inclusa.
Every model is supplied with a 100 cm (39 1/4") chain.

	Riyadh 5349/06	Riyadh 5349/09	Riyadh 5349/12
Peso Weight	19 kg 42 lb	26 kg 58 lb	32 kg 71 lb
Lampadine Bulbs	N. Tipo W max. 6 E14 60	N. Tipo W max. 9 E14 60	N. Tipo W max. 12 E14 60
Dimmerabile Dimmable	D	D	D
Lampadine incluse Bulbs included			
Certificazioni Certification Marks			

Colori disponibili Available colours



CC
Cristallo
Crystal



BB
Bianco
White



IC
Grigio
Grey



EK
Sabbia
Sand



DK
Oliva
Olive



LQ
Bluastro
Bluastro



FK
Indaco
Indigo



CK
Perivinka
Periwinkle



***OO**
Oro
Gold
*Solo OG
Only OG



NN
Nero
Black

Finiture Finishings



CL
Cromo Lucido
Polished Chrome



***OG**
Oro Galvanizzato
Galvanized Gold
*Solo OO
Only OO

ROSATI

Questa collezione nasce attingendo ai disegni del prezioso archivio storico di Barovier&Toso rielaborati e riproposti con un design più moderno. Linee sobrie ed eleganti, che vanno al di là delle mode. Ogni tazzina ospita al suo interno un "rostrato", piccolo gioiello di invenzione, che protegge alla vista la lampadina la cui luce si moltiplica all'infinito, passando attraverso le cuspidi che sono l'essenza stessa del rostrato.

This collection takes its cue from drawings conserved in the precious historical archives of Barovier&Toso, reworked and reformulated with a more modern design. Simple, elegant lines that transcend fashion. Each candle cup holds a little stroke of genius: a "rostrato", a piece of glass with extruded pointed tips, which hides the lamps from view. Their light is refracted infinitely as it passes through the glass tips that are at the heart of the "rostrato" technique.



Modelli e misure
Models and sizes

*Ogni modello prevede una catena di 100 cm inclusa.
 Every model is supplied with a 100 cm (39 1/4") chain.

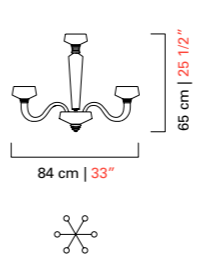
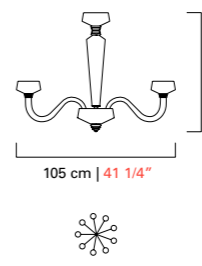
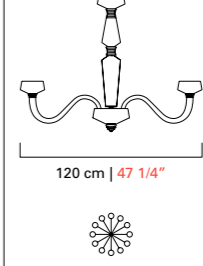
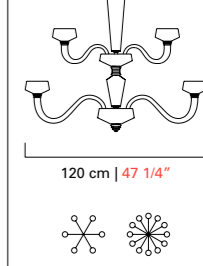
	Rosati 5716/06	Rosati 5716/09	Rosati 5716/12	Rosati 5716/18
				
Peso Weight	13 kg 29 lb	17 kg 37 lb	24 kg 53 lb	35 kg 77 lb
Lampadine Bulbs	N. Tipo/Type W max. 6+1+1 G9 + G4 + Strip Led 40+1,5+1,4	9+1+1 G9 + G4 + Strip Led 40+1,5+1,4	12+1+2 G9 + G4 + Strip Led 40+1,5+1,4	18+1+2 G9 + G4 + Strip Led 40+1,5+1,4
Dimmerabile Dimmable	D G9	D G9	D G9	D G9
Lampadine incluse Bulbs included	G9 Led + G4 Led + Strip Led	G9 Led + G4 Led + Strip Led	G9 Led + G4 Led + Strip Led	G9 Led + G4 Led + Strip Led
Certificazioni Certification Marks				

Colori disponibili
Available colours

CC
 Cristallo
Crystal

IC
 Grigio
Grey

EK
 Sabbia
Sand

DK
 Oliva
Olive

AK
 Blu Cadetto
Cadet Blue

LQ
 Bluastro
Bluastro

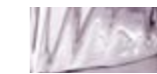
FK
 Indaco
Indigo

CK
 Pervinca
Periwinkle

VI
 Viola
Violet

***OO**
 Oro
Gold
 *Solo OO
Only OO
Finiture
Finishings

CL
 Cromo Lucido
Polished Chrome

***OG**
 Oro Galvanizzato
Galvanized Gold
 *Solo OO
Only OO

ROTTERDAM

Bracci curvati verso l'alto, fusto ogivale, rocchetti di cristallo creati artigianalmente utilizzando un brevetto Barovier&Toso: il "rostrato". Oggetti preziosi, di straordinaria eleganza e raffinatezza capaci di soddisfare un cliente esigente e sofisticato.

Arms curving upward, an oval trunk, crystal spoons created by hand using a Barovier&Toso patent: "rostrato." Precious objects of extraordinary elegance and refinement, capable of satisfying the most demanding and sophisticated customers.



Modelli e misure
Models and sizes

*Ogni modello prevede una catena di 100 cm inclusa.
Every model is supplied with a 100 cm (39 1/4") chain.

	Rotterdam 5563/05	Rotterdam 5563/08	Rotterdam 5563/10	Rotterdam 5563/14
Peso Weight	19 kg 42 lb	24 kg 53 lb	29 kg 64 lb	35 kg 77 lb
Lampadine N. Tipo W max. Bulbs N. Type W max.	5 E14 60 E12 60	8 E14 60 E12 60	10 E14 60 E12 60	14 E14 60 E12 60
Dimmerabile Dimmable	D	D	D	D
Lampadine incluse Bulbs included				
Certificazioni Cerification Marks				

Colori disponibili
Available colours

CC Cristallo <i>Crystal</i>	IC Grigio <i>Grey</i>	EK Sabbia <i>Sand</i>	DK Oliva <i>Olive</i>	AK Blu Cadetto <i>Cadet Blue</i>
LQ Bluastro <i>Bluastro</i>	FK Indaco <i>Indigo</i>	CK Pervinca <i>Periwinkle</i>	VI Viola <i>Violet</i>	*OO Oro <i>Gold</i> *Solo OG <i>Only OG</i>

Finiture
Finishings

CL Cromo Lucido <i>Polished Chrome</i>	*OG Oro Galvanizzato <i>Galvanized Gold</i> *Solo OO <i>Only OO</i>

Paralumi
Shades

Esterno: Cotone
External: Cotton

BB Bianco <i>White</i>	NN Nero <i>Black</i>	NO Nero Interno Oro <i>Black Inner Gold</i>	

Modelli e misure
Models and sizes

*Ogni modello prevede una catena di 100 cm inclusa.
Every model is supplied with a 100 cm (39 1/4") chain.

	Rotterdam 5563/18	Rotterdam 5563/24
Peso Weight	41 kg 90 lb	53 kg 117 lb
Lampadine N. Tipo W max. Bulbs N. Type W max.	18 E14 60 E12 60	24 E14 60 E12 60
Dimmerabile Dimmable	D	D
Lampadine incluse Bulbs included		
Certificazioni Cerification Marks		

SAINT GERMAIN

Giorgia Brusemini

Una collezione che parte dal concetto di bidimensionalità allineando i bracci lungo lo stesso asse per dar vita ad oggetti di dimensioni contenute che non perdono tuttavia la poesia e l'incanto di un prodotto interamente realizzato a mano in cristallo veneziano. Elemento distintivo è la sfera realizzata con la tecnica dell'oro sommerso.

A collection that starts with the concept of two dimensions, extending its arms along the same axis to give rise to objects of compact size that do not, however, lose any of their poetry and enchantment. A product made entirely by hand in Venetian crystal, featuring a distinctive sphere made with the "oro sommerso" technique.



Modelli e misure Models and sizes

*Ogni modello prevede una catena di 100 cm inclusa.
Every model is supplied with a 100 cm (39 1/4") chain.

	Saint Germain 7060	Saint Germain 7061	Saint Germain 7062	Saint Germain 7063
Peso Weight	9 kg 20 lb	10 kg 22 lb	13 kg 29 lb	16 kg 35 lb
Lampadine Bulbs	N. Tipo W max. 2 E14 60	N. Tipo W max. 3 E14 60	N. Tipo W max. 5 E14 60	N. Tipo W max. 7 E14 60
Dimmerabile Dimmable	D	D	D	D
Lampadine incluse Bulbs included				
Certificazioni Certification Marks				

Colori disponibili Available colours



CC
Cristallo
Crystal



IC
Grigio
Grey



EK
Sabbia
Sand



DK
Oliva
Olive



AK
Blu Cadetto
Cadet Blue



LQ
Bluastro
Bluastro



FK
Indaco
Indigo



CK
Pervinca
Periwinkle



VI
Viola
Violet



OO
Oro
Gold

Finiture Finishings



CL
Cromo Lucido
Polished Chrome



OG
Oro Galvanizzato
Galvanized Gold

Paralumi Shades

Esterno: Cotone
External: Cotton

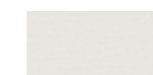
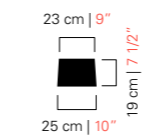

BB
Bianco
White



NN
Nero
Black



NO
Nero Interno Oro
Black Inner Gold

SAN GIORGIO

Lampadari ricchi di decorazioni molto particolari come i pendagli soffiati a forma di ampolla nella stessa colorazione dei bracci e le piramidi (punte attorcigliate). Caratteristica singolare è anche la struttura a gabbia ritorta che genera un insolito effetto di torsione enfatizzato anche dall'atipica interruzione del fusto centrale.

Chandeliers full of specific decorations such as the ampoule shaped pendants, mouth blown in the same colour of the arms, and the pyramids (curled points). The twisted main frame is a unique feature that creates an unusual torsion emphasized also by the atypical break in the central trunk.



Modelli e misure Models and sizes

*Ogni modello prevede una catena di 100 cm inclusa.
Every model is supplied with a 100 cm (39 1/4") chain.

	San Giorgio 5558/12	San Giorgio 5558/16
Peso Weight	40 kg 88 lb	65 kg 143 lb
Lampadine Bulbs	N. Tipo W max. 12 E14 60	N. Tipo W max. 16 E14 60
Dimmerabile Dimmable	D	D
Lampadine incluse Bulbs included		
Certificazioni Certification Marks		

Colori disponibili Available colours



CC
Cristallo
Crystal



BB
Bianco
White



IC
Grigio
Grey



EK
Sabbia
Sand



DK
Oliva
Olive



LQ
Bluastro
Bluastro



FK
Indaco
Indigo

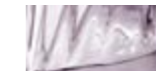

CK
Pervinca
Periwinkle



***OO**
Oro
Gold
*Solo OG
Only OG



NN
Nero
Black

Finiture Finishings



CL
Cromo Lucido
Polished Chrome



***OG**
Oro Galvanizzato
Galvanized Gold
*Solo OO
Only OO

TAIF

Un'icona, sintesi perfetta di esperienze e materiali diversi, che sbalordisce per la sua ineguagliabile armonia. Un lampadario di grande successo che nasce nel 1980 per illuminare la residenza del re saudita a Taif, città da cui prende il nome. Angelo Barovier ripensa l'immagine del lampadario della tradizione muranese, preservando il valore del cristallo veneziano e accogliendo nuovi linguaggi per approdare infine all'equilibrio compiuto del Classico.

An icon; the perfect synthesis of experience and selected materials wrought with stunning and unequalled harmony. Taif was created in 1980 for the home of the Saudi king in the eponymous city of Taif, whence comes the name. Angelo Barovier rethought the image of the traditional Murano chandelier, preserving the value of Venetian crystal while incorporating new languages. An amalgam, then, of tradition and creativity, of memory and innovation, from which blossoms the time-tested equilibrium of the classical.

Mood Taif design Franco Raggi

Un lampadario non comune, dove i bracci sono disposti in orizzontale e non gravitano - come di consueto - attorno ad un centro. Il designer ha inteso così destrutturare questo modello storico delle collezioni Barovier&Toso ri assemblandolo in una composizione nuova.

An unusual chandelier, where the arms are arranged horizontally and do not gravitate around a center - as is usually the case. The designer reinterprets this historical model from Barovier&Toso collections giving it a new shape.

Torpedo Taif

Un lampadario fuori dal comune, sviluppato prevalentemente in altezza (fino 280 cm), adatto ad illuminare ambienti di rappresentanza o scenografie di grande impatto.

An out-of-the-ordinary chandelier developed mainly in height (up to two 110"), suitable for illuminating representative environments or settings of great impact.





Mood Taif 7023



Torpedo Taif 7143/12

Modelli e misure <i>Models and sizes</i>	Taif	Taif	Taif	Taif
	5350/06	5350/09	5350/12	5350/18
<p>*Per Taif e Torpedo Taif è prevista una catena di 100 cm inclusa. Taif and Torpedo Taif are supplied with a 100 cm (39 1/4") chain.</p>				
Peso Weight	30 kg 66 lb	42 kg 93 lb	55 kg 122 lb	74 kg 163 lb
Lampadine N. Tipo W max. Bulbs N. Type W max.	6 E14 60 E12 60	9 E14 60 E12 60	12 E14 60 E12 60	18 E14 60 E12 60
Dimmerabile Dimmable	D	D	D	D
Lampadine incluse Bulbs included				
Certificazioni Certification Marks				

Modelli e misure <i>Models and sizes</i>	Mood Taif	Mood Taif	Mood Taif
	7022	7023	7024
Peso Weight	12 kg 26 lb	16 kg 35 lb	35 kg 77 lb
Lampadine N. Tipo W max. Bulbs N. Type W max.	8 E14 60 E12 60	12 E14 60 E12 60	16 E14 60 E12 60
Dimmerabile Dimmable	D	D	D
Lampadine incluse Bulbs included			
Certificazioni Certification Marks			

Modelli e misure <i>Models and sizes</i>	Torpedo Taif	Torpedo Taif	Torpedo Taif
	7143/09	7143/12	7143/18
<p>*Per Taif e Torpedo Taif è prevista una catena di 100 cm inclusa. Taif and Torpedo Taif are supplied with a 100 cm (39 1/4") chain.</p>			
Peso Weight	22 kg 48 lb	28 kg 62 lb	40 kg 88 lb
Lampadine N. Tipo W max. Bulbs N. Type W max.	9 E14 60 E12 60	12 E14 60 E12 60	18 E14 60 E12 60
Dimmerabile Dimmable	D	D	D
Lampadine incluse Bulbs included			
Certificazioni Certification Marks			

Colori disponibili <i>Available colours</i>	CC	BB	IC	EK	DK
	CC Cristallo Crystal	BB Bianco White	IC Grigio Grey	EK Sabbia Sand	DK Oliva Olive
	LQ Bluastro Bluastro	FK Indaco Indigo	CK Pervinca Periwinkle	*OO Oro Gold	NN Nero Black

*Per Taif e Torpedo Taif la finitura abbinata al colore OO è sempre OG. Per Mood Taif la finitura abbinata al colore OO può essere CL, CN o OF.
For Taif and Torpedo Taif the finishing matching colour OO is always OG. For Mood Taif the finishings matching colour OO can be CL, CN or OF.

Finiture <i>Finishings</i>	CL	*OG	*CN	*OF
	CL Cromo Lucido Polished Chrome	*OG Oro Galvanizzato Galvanized Gold *Solo OO Taif e OO Torpedo Taif Only OO Taif and OO Torpedo Taif	*CN Cromo Nero Dark Chrome *Solo Mood Taif Only Mood Taif	*OF Ottone Spazzolato Fine Fine Brushed Brass *Solo Mood Taif Only Mood Taif

TANGERI

Sfere riccamente decorate e pastorali abilmente ritorti si alternano in questa collezione che attinge alla tradizione ma il cui disegno, alleggerito e semplificato, ben si adatta sia ad interni di gusto classico che contemporaneo. I paralumi con la finitura interna oro sono perfetti per donare un'atmosfera calda e ricercata.

Richly decorated spheres and gracefully curled pastorals alternate in this collection that draws on the tradition while, lightening and simplifying the design, makes it perfect for both classic and contemporary settings. The shades with an inner gold finish produce a warm, refined atmosphere.



Modelli e misure Models and sizes

*Ogni modello prevede una catena di 100 cm inclusa.
Every model is supplied with a 100 cm (39 1/4") chain.

	Tangeri 5604/08	Tangeri 5604/12	Tangeri 5604/16
Peso Weight	15 kg 33 lb	23 kg 51 lb	45 kg 99 lb
Lampadine Bulbs	N. Tipo W max. 8 E14 60	N. Tipo W max. 12 E14 60	N. Tipo W max. 16 E14 60
Dimmerabile Dimmable	D	D	D
Lampadine incluse Bulbs included			
Certificazioni Certification Marks			

Colori disponibili Available colours



CC
Cristallo
Crystal



IC
Grigio
Grey



EK
Sabbia
Sand



DK
Oliva
Olive



AK
Blu Cadetto
Cadet Blue



LQ
Bluastro
Bluastro



FK
Indaco
Indigo



CK
Pervinca
Periwinkle

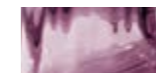

VI
Viola
Violet



***OO**
Oro
Gold
*Solo OG
Only OG

Finiture Finishings



CL
Cromo Lucido
Polished Chrome



***OG**
Oro Galvanizzato
Galvanized Gold
*Solo OO
Only OO

Paralumi Shades

Esterno: Cotone
External: Cotton

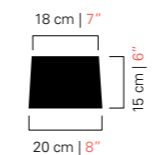

20 cm | 8"

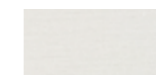

BB
Bianco
White



NN
Nero
Black



NO
Nero Interno Oro
Black Inner Gold

TAYMYR





I pendagli a bolla soffiati in cristallo veneziano, i bracci su piani sfalsati e le lunghe candele dalla finitura metallica sono le peculiarità di questa famiglia. La lampadina di foggia cilindrica rende più moderno l'insieme.

Bubble pendants in mouth blown Venetian crystal, arms on different levels and long metal-finish candles are the key features of this family of chandeliers. The cylindrical bulbs enhance the modernity of the whole.

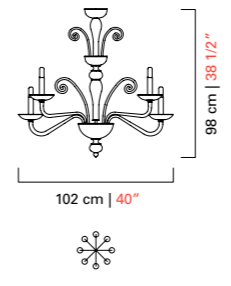
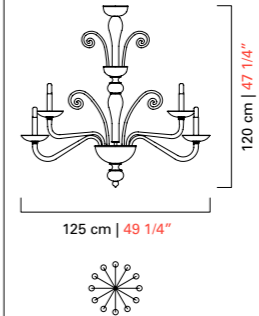
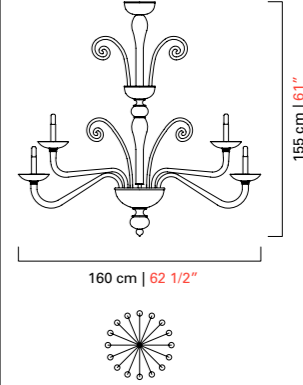

Modelli e misure Models and sizes

*Ogni modello prevede una catena di 100 cm inclusa.
Every model is supplied with a 100 cm (39 1/4") chain.

	Taymyr 5589/08	Taymyr 5589/12	Taymyr 5589/16
			
Peso Weight	18 kg 40 lb	35 kg 77 lb	45 kg 99 lb
Lampadine Bulbs	N. Tipo W max. 8 E14 60	N. Tipo W max. 12 E14 60	N. Tipo W max. 16 E14 60
Dimmerabile Dimmable	D	D	D
Lampadine incluse Bulbs included			
Certificazioni Certification Marks			

Colori disponibili Available colours



CC
Cristallo
Crystal



IC
Grigio
Grey



EK
Sabbia
Sand



DK
Oliva
Olive



AK
Blu Cadetto
Cadet Blue



LQ
Bluastro
Bluastro



FK
Indaco
Indigo



CK
Pervinca
Perwinkle



VI
Viola
Violet



***OO**
Oro
Gold
*Solo OO
Only OO

Finiture Finishings



CL
Cromo Lucido
Polished Chrome



***OG**
Oro Galvanizzato
Galvanized Gold
*Solo OO
Only OO





TWINS

Come in un passato mai passato la materia vetro prende forma, e la luce si alterna alle ombre in un vigoroso abbraccio vorticante. Sulle orme dei successi del passato recente, un lampadario orizzontale dall'aspetto vigoroso ma raffinato. Il cristallo dei bracci, molto materico, è trasparente mentre le lampade sono racchiuse in tazzine di colore bianco opaco che diffonde e ammorbidisce la luce.

In a past that is ever present, the glass takes shape and light alternates with shadows to generate a vigorous, vertiginous embrace. On the heels of the successes of the recent past, an horizontal chandelier with a vigorous yet refined appearance. The arms' crystal, which is very material, is transparent, while the light bulbs are enclosed in opaque white cups which diffuse and soften the light.

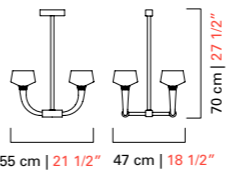
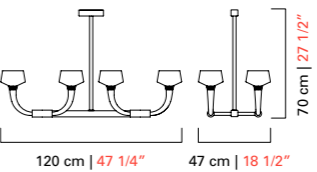
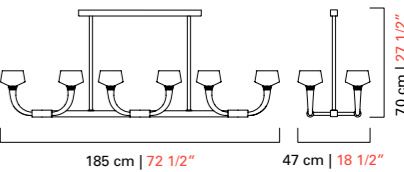

Modelli e misure Models and sizes

	Twins 7226/04	Twins 7226/08	Twins 7226/12
			
Peso Weight	10 kg 22 lb	18 kg 40 lb	32 kg 70 lb
Lampadine N. Tipo W max. Bulbs N. Type W max.	4 G9 40 40	8 G9 40 40	12 G9 40 40
Dimmerabile Dimmable	D	D	D
Lampadine incluse Bulbs included	G9 Led	G9 Led	G9 Led
Certificazioni Certification Marks			

Colori disponibili Available colours



CC
Cristallo
Crystal



OO
Oro
Gold

Finiture Finishings



CL
Cromo Lucido
Polished Chrome



CN
Cromo Nero
Dark Chrome



OF
Ottone
Spazzolato Fine
Fine Brushed Brass

VALIANT

Un disegno anni '20, linee pulite, solo alcuni elementi decorativi ed una disposizione insolitamente fitta dei bracci. Un oggetto essenziale che non passa mai di moda particolarmente adatto ad ambienti contemporanei.

A drawing from the 20ies, clean lines, just few decorative elements and an unusually dense arrangement of the arms. An essential object that never goes out of fashion, particularly suitable for contemporary interiors.



Modelli e misure Models and sizes

*Ogni modello prevede una catena di 100 cm inclusa.
Every model is supplied with a 100 cm (39 1/4") chain.

	Valiant 5507/06	Valiant 5507/09	Valiant 5507/12	Valiant 5507/18
Peso Weight	8 kg 18 lb	10 kg 22 lb	13 kg 29 lb	20 kg 44 lb
Lampadine Bulbs	N. Tipo W max. 6 E14 60	N. Tipo W max. 9 E14 60	N. Tipo W max. 12 E14 60	N. Tipo W max. 18 E14 60
Dimmerabile Dimmable	D	D	D	D
Lampadine incluse Bulbs included				
Certificazioni Certification Marks				

Colori disponibili Available colours



CC
Cristallo
Crystal



IC
Grigio
Grey



EK
Sabbia
Sand



DK
Oliva
Olive



AK
Blu Cadetto
Cadet Blue



LQ
Bluastro
Bluastro



FK
Indaco
Indigo

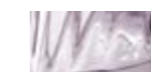

CK
Pervinca
Periwinkle



VI
Viola
Violet



***OO**
Oro
Gold
*Solo OG
Only OG

Finiture Finishings



CL
Cromo Lucido
Polished Chrome



***OG**
Oro Galvanizzato
Galvanized Gold
*Solo OG
Only OG

ENEZIA 1295

L'origine di tutto, il compendio di settecento anni di tradizioni tramandate di padre in figlio, oltre le mode e il tempo che scorre: una collezione di lampadari ricca di storia, di dettagli e di emozioni. È composta da quattro lampadari tutti caratterizzati da un elemento ricorrente: il "rostrato", un'invenzione del secolo scorso di Ercole Barovier che prende origine dalle tecniche di lavorazione artigianali dei suoi avi.

At the very heart of it all is the culmination of seven hundred years of tradition handed down from father to son through changing times and fashions: a collection of chandeliers rich in history, detail and emotion. It is comprised of four chandeliers all featuring a recurring motif: "rostrato", invented by Ercole Barovier almost a century ago developing techniques used by his ancestors.



Modelli e misure
Models and sizes

*Ogni modello prevede una catena di 100 cm inclusa.
Every model is supplied with a 100 cm (39 1/4") chain.

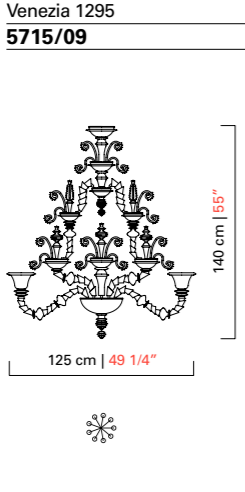
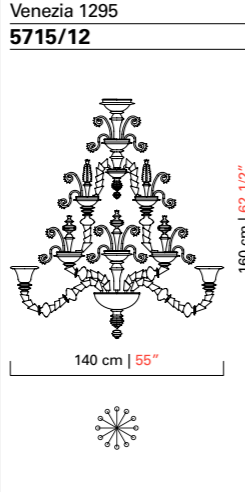
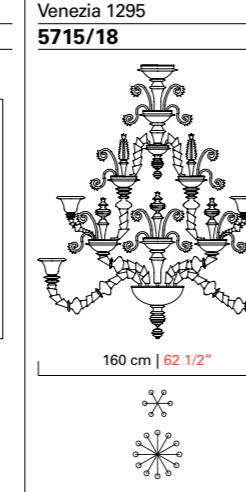
	Venezia 1295 5715/09	Venezia 1295 5715/12	Venezia 1295 5715/18
			
Peso Weight	49 kg 107 lb	62 kg 136 lb	85 kg 187 lb
Lampadine N. Tipo W max. Bulbs N. Type W max.	9 E14 60 E12 60	12 E14 60 E12 60	18 E14 60 E12 60
Dimmerabile Dimmable	D	D	D
Lampadine incluse Bulbs included			
Certificazioni Certification Marks			

Colori disponibili
Available colours



CC
Cristallo
Crystal

Finiture
Finishings



CL
Cromo Lucido
Polished Chrome



OG
Oro Galvanizzato
Galvanized Gold

Modelli e misure
Models and sizes

*Ogni modello prevede una catena di 100 cm inclusa.
Every model is supplied with a 100 cm (39 1/4") chain.

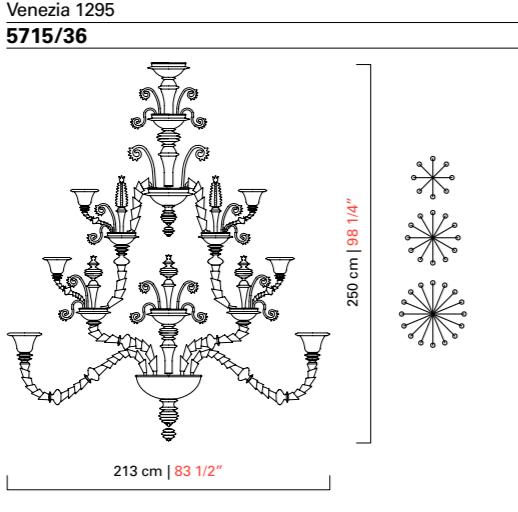
	Venezia 1295 5715/36
	
Peso Weight	185 kg 407 lb
Lampadine N. Tipo W max. Bulbs N. Type W max.	36 E14 60 E12 60
Dimmerabile Dimmable	D
Lampadine incluse Bulbs included	
Certificazioni Certification Marks	

VERMONT

Elemento caratterizzante di questa collezione sono le grandi sfere in cristallo veneziano soffiato. Si distribuiscono sia in verticale che in orizzontale come a formare un'eterea ma preziosa nuvola di vetro.

The large Venetian crystal spheres are the distinctive elements of this collection. With their horizontal and vertical distribution, they generate an ethereal but at the same time precious crystal cloud.



Modelli e misure Models and sizes

*Ogni modello prevede una catena di 100 cm inclusa.
Every model is supplied with a 100 cm (39 1/4") chain.

	Vermont 5550/06/A	Vermont 5550/09/A	Vermont 5550/12/A	Vermont 5550/18/A
Peso Weight	10 kg 22 lb	13 kg 29 lb	16 kg 36 lb	24 kg 53 lb
Lampadine N. Tipo W max. Bulbs N. Type W max.	6 E14 60 E12 60	9 E14 60 E12 60	12 E14 60 E12 60	18 E14 60 E12 60
Dimmerabile Dimmable	D	D	D	D
Lampadine incluse Bulbs included				
Certificazioni Cerification Marks				

Colori disponibili Available colours



CC
Cristallo
Crystal



IC
Grigio
Grey



EK
Sabbia
Sand



DK
Oliva
Olive



AK
Blu Cadetto
Cadet Blue



LQ
Bluastro
Bluastro



FK
Indaco
Indigo



CK
Perivnca
Periwinkle

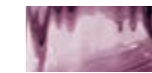

VI
Viola
Violet



***OO**
Oro
Gold
*Solo OO
Only OO

Finiture Finishings



CL
Cromo Lucido
Polished Chrome



***OG**
Oro Galvanizzato
Galvanized Gold
*Solo OO
Only OO

Paralumi Shades

Esterno: Cotone
External: Cotton

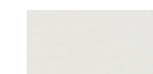
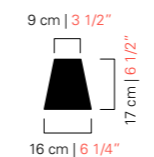

BB
Bianco
White



NN
Nero
Black



NO
Nero Interno Oro
Black Inner Gold

VERTIGO

Vertigo si ispira alle atmosfere glamour ed ammalianti degli anni '20, capaci di rievocare quel vivace fermento che investì le arti visive, il design, l'architettura e la moda dell'epoca. Attingendo a quelle vibranti tendenze estetiche, che videro New York, Mosca, Berlino e Parigi trasformarsi in capitali del lusso, del divertimento e della bella vita. Una nuova collezione affascinante e raffinata, carica di una tensione espressiva intensa e sensuale.

Vertigo takes its cue from the glamorous, seductive atmospheres of the 1920s, drawing on the lively ferment in the visual arts, design, architecture and fashion in that period. Referencing the vibrant aesthetic trends that made New York, Moscow, Berlin and Paris into worldwide capitals of luxury, entertainment and lifestyle. A new collection fascinating and refined, charged with intense and sensual expressive energy.



Modelli e misure
Models and sizes

*Ogni modello prevede una catena di 100 cm inclusa.
 Every model is supplied with a 100 cm (39 1/4") chain.

	Vertigo 5719/06	Vertigo 5719/09	Vertigo 5719/12	Vertigo 5719/18
	 90 cm 35 1/2" 85 cm 33 1/2"	 120 cm 47 1/4" 105 cm 41 1/4"	 145 cm 57" 120 cm 47 1/4"	 145 cm 57" 160 cm 62 1/2"
Peso Weight	12 kg 26 lb	17 kg 37 lb	25 kg 55 lb	38 kg 84 lb
Lampadine Bulbs	N. Tipo W max. 6+1 G9+G4 7+1,5	N. Tipo W max. 9+1 G9+G4 7+1,5	N. Tipo W max. 12+1 G9+G4 7+1,5	N. Tipo W max. 18+1 G9+G4 7+1,5
Dimmerabile Dimmable	D G9	D G9	D G9	D G9
Lampadine incluse Bulbs included	G9 Led + G4 Led	G9 Led + G4 Led	G9 Led + G4 Led	G9 Led + G4 Led
Certificazioni Cerification Marks				

Colori disponibili
Available colours

CC
 Cristallo
 Crystal

IC
 Grigio
 Grey

EK
 Sabbia
 Sand

DK
 Oliva
 Olive

AK
 Blu Cadetto
 Cadet Blue

LQ
 Bluastro
 Bluastro

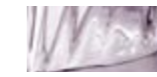
FK
 Indaco
 Indigo

CK
 Pervinca
 Periwinkle

VI
 Viola
 Violet

OO
 Oro
 Gold

Finiture
Finishings

NJ
 Nickel Nero
 Spazzolato
 Brushed Black
 Nickel

OJ
 Oro Spazzolato
 Brushed Gold

WINDSOR

Bracci sinuosi ed eleganti, che si dipanano da un corpo centrale snello e slanciato in un gioco visivo di intrecci, e si allineano ingegnosamente su uno stesso piano, sono la peculiarità della collezione. Le tazzine portalampada sono sempre bianco opaco con una sfumatura nella stessa tonalità dei bracci.

Sinuuous, elegant arms which unfurl from a slender central body in a visual game of twists, and which are smartly aligned on a same plane: these are the distinctive features of the collection. The lamp-holder cups are always opaque white with a shade whose tonality is the same as the arms.



Modelli e misure Models and sizes

*Ogni modello prevede una catena di 100 cm inclusa.
Every model is supplied with a 100 cm (39 1/4") chain.

	Windsor 5676/10	Windsor 5676/14	Windsor 5676/24
Peso Weight	21 kg 46 lb	33 kg 73 lb	50 kg 110 lb
Lampadine Bulbs	N. 10 Tipo E14 W max. 60	N. 14 Tipo E14 W max. 60	N. 24 Tipo E14 W max. 60
Dimmerabile Dimmable	D	D	D
Lampadine incluse Bulbs included			
Certificazioni Certification Marks			

Colori disponibili Available colours



CC
Cristallo
Crystal



IC
Grigio
Grey



EK
Sabbia
Sand



DK
Oliva
Olive



AK
Blu Cadetto
Cadet Blue



LQ
Bluastro
Bluastro



FK
Indaco
Indigo

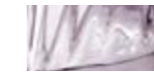

CK
Pervinca
Perwinkle

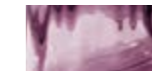

VI
Viola
Viola



***OO**
Oro
Gold
*Solo OO
Only OO

Finiture Finishings



CL
Cromo Lucido
Polished Chrome



***OG**
Oro Galvanizzato
Galvanized Gold
*Solo OO
Only OO



SUSPENSIONS

Una collezione ampiamente variegata e versatile, capace di rievocare altre epoche o di aggiungere un accento contemporaneo all'ambiente. Lavorazioni tradizionali sposano forme eclettiche, dando vita a creazioni che fluttuano sospese nell'aria.

A variegated and versatile collection capable of suggesting other eras, or of adding a contemporary accent to spaces. Traditional workmanship meets eclectic forms, in creations that seem to float in the air.

ANGEL



Al Design

Angel è una spirale di piume di cristallo, che si avvolge su sé stessa con dinamismo, e che fluttua nello spazio come un'ala vaporosa che si dispiega leggera. Ogni piuma è illuminata da led, così come l'attacco a soffitto.

Angel is a spiral of crystal plumage, which wraps around itself with dynamism and floats in space like a vaporous wing unfolding lightly. Each feather is lit by led, as well as the ceiling connection.

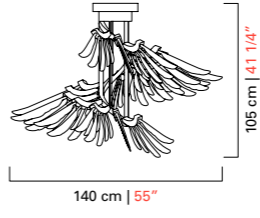
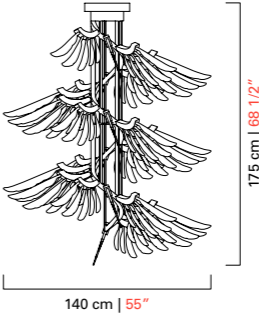

Modelli e misure Models and sizes

	Angel 7248	Angel 7249
		
Peso Weight	35 kg 77 lb	60 kg 132 lb
Lampadine Bulbs	N. Tipo/Type W max. 80+1+1 Led + GU10 + Strip Led 1+7+21	135+1+1 Led + GU10 + Strip Led 1+7+21
Dimmerabile Dimmable		
Lampadine incluse Bulbs included	Led + GU10 Led + Strip Led	Led + GU10 Led + Strip Led
Certificazioni Certification Marks		

Colori disponibili Available colours



CC
Cristallo
Crystal

Finiture Finishings



VM
Verniciato Mirra
Painted Myrrh

COLIMAÇON

Marc Sadler

Come sculture mobili queste sospensioni grazie alla cinetica dei bracci consentono di ottenere configurazioni sempre diverse. In antitesi alla staticità della sospensione tradizionale questi oggetti giocano con il delicato equilibrio tra pesi e dimensioni creando un effetto di estrema lievità e delicatezza. È proposto in nove modelli, ma le possibilità costruttive sono infinite.

Like mobile sculptures, thanks to the kinetics of the arms these suspensions make it possible to create many different configurations. As opposed to the static character of traditional lamps, these objects play with a delicate balance of weights and proportions to generate an effect of extreme lightness and delicacy. It is available in nine models, but with infinite possible combinations.

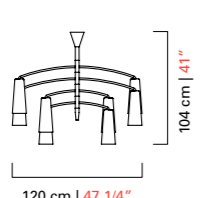
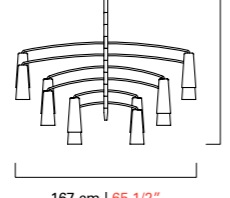
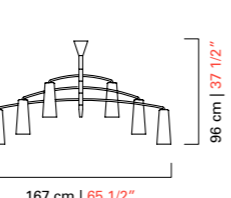
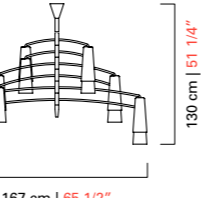

Modelli e misure <i>Models and sizes</i>	Colimaçon 7206	Colimaçon 7207	Colimaçon 7208	Colimaçon 7209
				
Peso Weight	28 kg 62 lb	43 kg 95 lb	23 kg 51 lb	42 kg 92 lb
Lampadine N. Tipo W max. Bulbs N. Type W max.	8 E14 40 E12 40	12 E14 40 E12 40	6 E14 40 E12 40	12 E14 40 E12 40
Dimmerabile Dimmable	D	D	D	D
Lampadine incluse Bulbs included				
Certificazioni Cerification Marks				

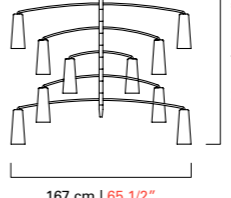
Modelli e misure <i>Models and sizes</i>	Colimaçon 7214
	
Peso Weight	37 kg 81 lb
Lampadine N. Tipo W max. Bulbs N. Type W max.	10 E14 40 E12 40
Dimmerabile Dimmable	D
Lampadine incluse Bulbs included	
Certificazioni Cerification Marks	

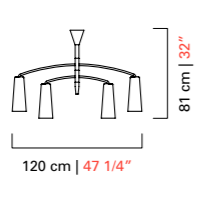
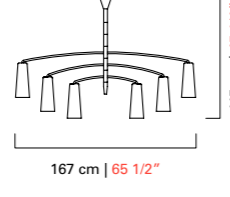
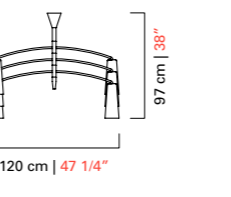
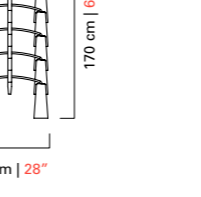
Modelli e misure <i>Models and sizes</i>	Colimaçon 7210	Colimaçon 7211	Colimaçon 7212	Colimaçon 7213
				
Peso Weight	16 kg 35 lb	23 kg 51 lb	23 kg 51 lb	35 kg 77 lb
Lampadine N. Tipo W max. Bulbs N. Type W max.	4 E14 40 E12 40	6 E14 40 E12 40	6 E14 40 E12 40	10 E14 40 E12 40
Dimmerabile Dimmable	D	D	D	D
Lampadine incluse Bulbs included				
Certificazioni Cerification Marks				

Colori disponibili <i>Available colours</i>			
	OB Oro Beige <i>Beige Gold</i>	IN Grigio Bianco <i>Grey White</i>	BH Bluastro Bianco <i>Bluastro White</i>
Finiture <i>Finishings</i>			
	CN Cromo Nero <i>Dark Chrome</i>	OG Oro Galvanizzato <i>Galvanized Gold</i>	

CROWN

Brian Rasmussen

Una collezione che celebra ed esalta uno degli elementi caratterizzanti dei lampadari della tradizione veneziana, il "pastorale": un piccolo bastone dall'estremità ritorta a spirale caratterizzato dalla lavorazione "rigà menà". Ingrandito a dismisura, appeso al contrario e replicato in serie diventa il protagonista di queste sospensioni dal disegno minimalista e moderno. Proposto in tre diverse configurazioni (a uno, due o tre livelli).

A collection that pays tribute to and enhances one of the characteristic features of the chandeliers of the Venetian tradition, the "pastorale": a small rod terminating in a spiral, made with the "rigà menà" technique. Forcefully enlarged, suspended upside-down and replicated in a series, this piece becomes the protagonist of suspension lamps with a modern minimalist design. Available in three different configurations (one, two or three-tiers).



Modelli e misure Models and sizes	Crown	Crown	Crown
	7334	7335	7336
Peso Weight	15 kg 33 lb	23 kg 51 lb	30 kg 66 lb
Lampadine N. Tipo W max. Bulbs N. Type W max.	1 Strip Led 46 46	1 Strip Led 73 73	1 Strip Led 105 105
Dimmerabile Dimmable	D	D	D
Lampadine incluse Bulbs included	Strip Led	Strip Led	Strip Led
Certificazioni Certification Marks	ERAC	ERAC	ERAC

Colori disponibili
Available colours

CC
Cristallo
Crystal

Finiture
Finishings

VY
Verniciato Grigio
Painted Grey

Modelli e misure Models and sizes	Crown	Crown	Crown
	7337	7338	7339
Peso Weight	39 kg 86 lb	55 kg 121 lb	70 kg 154 lb
Lampadine N. Tipo W max. Bulbs N. Type W max.	2 Strip Led 46+73 46+73	2 Strip Led 73+105 73+105	3 Strip Led 46+73+105 46+73+105
Dimmerabile Dimmable	D	D	D
Lampadine incluse Bulbs included	Strip Led	Strip Led	Strip Led
Certificazioni Certification Marks	ERAC	ERAC	ERAC

EVA

Le grandi ogive sospese identificano questa collezione estremamente moderna. La leggerezza è la caratteristica principale che la rende adatta ad ogni progetto di interni.

The great hanging ogives identify this modern collection. Lightness is the main feature which makes it suitable for any interior design project.



Modelli e misure Models and sizes

Eva
7057

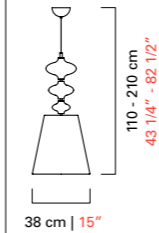

Peso Weight	8 kg 18 lb
Lampadine Bulbs	N. Tipo W max. N. Type W max. 1 E27 100 E26 60
Dimmerabile Dimmable	D
Lampadine incluse Bulbs included	
Certificazioni Certification Marks	UL ENEC c UL US

Colori disponibili Available colours



CC
Cristallo
Crystal



IC
Grigio
Grey



EK
Sabbia
Sand



DK
Oliva
Olive



AK
Blu Cadetto
Cadet Blue



LQ
Bluastro
Bluastro



FK
Indaco
Indigo



CK
Perivinka
Periwinkle



VI
Viola
Violet



OO
Oro
Gold

Finiture Finishings



CN
Cromo Nero
Dark Chrome



OF
Ottone
Spazzolato Fine
Fine Brushed Brass

Paralumi Shades

Esterno: Cotone
External: Cotton

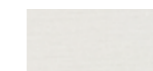
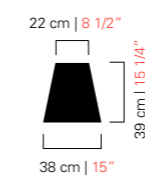

BB
Bianco
White



NN
Nero
Black







NO
Nero Interno Oro
Black Inner Gold

EXAGON

Come lucciole che si librano nelle profondità di una cascata di vetro, in una danza luminosa che affascina e crea atmosfera, queste foglie di loto, trasparenti e impreziosite da piccole scaglie d'oro oppure in colori tenui, fluttuano luminose.

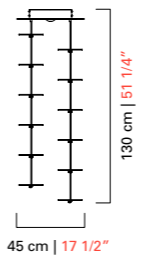
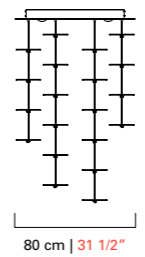
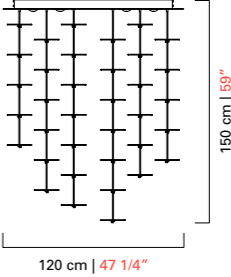
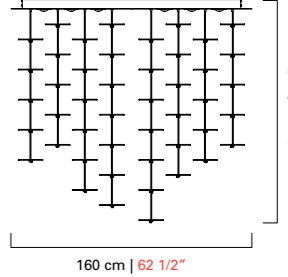
As fireflies unleashed from the depths of a glass cascade in a sparkling dance, creating an enchanting atmosphere, these transparent lotus leaves, embellished with tiny gold flakes or in pale colours, float in the air.



Modelli e misure Models and sizes	Exagon 7125	Exagon 7126	Exagon 7127	Exagon 7128
				
Peso Weight	18 kg 40 lb	45 kg 99 lb	100 kg 220 lb	155 kg 341 lb
Lampadine N. Tipo W max. Bulbs N. Type W max.	1+18 G53+Led 15+0,36	4+56 G53+Led 15+0,36	12+136 G53+Led 15+0,36	16+200 G53+Led 15+0,36
Dimmerabile Dimmable	D (G53)	D (G53)	D (G53)	D (G53)
Lampadine incluse Bulbs included	G53 Led + Led	G53 Led + Led	G53 Led + Led	G53 Led + Led
Certificazioni Certification Marks				

Colori disponibili Available colours



CC
Cristallo
Crystal



IC
Grigio
Grey



EK
Sabbia
Sand



DK
Oliva
Olive



AK
Blu Cadetto
Cadet Blue



LQ
Bluastro
Bluastro



FK
Indaco
Indigo

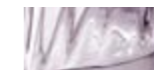

CK
Pervinca
Periwinkle



VI
Viola
Violet



OO
Oro
Gold

Finiture Finishings







CL
Cromo Lucido
Polished Chrome

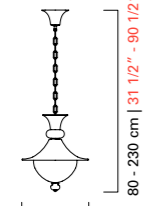
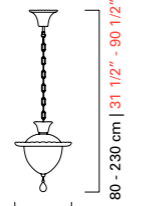
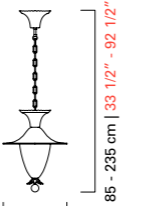

FANALI VENEZIANI

Una collezione che rende omaggio alla storia della città di Venezia e alle lanterne usate durante il medioevo per illuminare le calli. Un disegno classico ed elegante declinato in cinque tipologie da usare singolarmente o in serie.

A collection that pays homage to the history of the city of Venice and the lanterns used in the Middle Ages to light the streets. A classic and elegant design interpreted in five typologies that can be used individually or in groups.

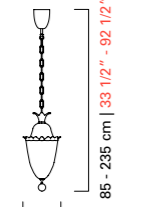

Modelli e misure <i>Models and sizes</i>	Fanali Veneziani			Fanali Veneziani			Fanali Veneziani			Fanali Veneziani					
	5381			5382			5383			4428					
	80 - 230 cm 31 1/2" - 90 1/2"						80 - 230 cm 31 1/2" - 90 1/2"						85 - 235 cm 33 1/2" - 92 1/2"		
	44 cm 17 1/4"			37 cm 14 1/2"			42 cm 16 1/2"			32 cm 12 1/2"					
Peso Weight	7 kg 15 lb			7 kg 15 lb			7 kg 15 lb			6 kg 13 lb					
Lampadine N. Tipo W max. Bulbs N. Type W max.	1	E27	100	1	E27	100	1	E27	100	1	E27	100	1	E27	100
		E26	100		E26	100		E26	100		E26	100		E26	100
Dimmerabile Dimmable	D			D			D			D					
Lampadine incluse Bulbs included															
Certificazioni Certification Marks															

Modelli e misure <i>Models and sizes</i>	Fanali Veneziani		
	4430		
	85 - 235 cm 33 1/2" - 92 1/2"		
	25 cm 10"		
Peso Weight	6 kg 13 lb		
Lampadine N. Tipo W max. Bulbs N. Type W max.	1	E27	100
		E26	100
Dimmerabile Dimmable	D		
Lampadine incluse Bulbs included			
Certificazioni Certification Marks			

Colori disponibili
Available colours**CC**
Cristallo
Crystal**DO**
Cristallo
Decoro Oro
*Crystal Gold
Decoration***OO**
Oro
Gold**OB**
Oro Beige
*Beige Gold***Finiture**
Finishings**OG**
Oro Galvanizzato
Galvanized Gold

GALLIA

Una famiglia di lampade eleganti ispirate alla regolarità del classico e rese senza tempo dai colori caldi e avvolgenti: il diffusore opalino è beige con pagliuzze dorate, mentre varia il colore dell'elemento sferico. La sospensione è disponibile con due o quattro luci, la prima anche in due altezze diverse.

A family of elegant lamps inspired by regular, classical lines and rendered timeless by the warm and welcoming colours: the opaline diffuser is beige, speckled with gold, while the sphere element can be of different colours. The suspension lamp is available with two or four lights, the first one also in two different heights.



Modelli e misure Models and sizes

	Gallia 5628/085	Gallia 5628/110	Gallia 5629
Peso Weight	9 kg 20 lb	10 kg 22 lb	20 kg 44 lb
Lampadine Bulbs	N. Tipo W max. 2 E27 100	N. Tipo W max. 2 E27 100	N. Tipo W max. 4 E27 100
Dimmerabile Dimmable	D	D	D
Lampadine incluse Bulbs included			
Certificazioni Certification Marks			

Colori disponibili Available colours

*A ogni colore è sempre abbinata la foglia oro.
Each colour is always combined with gold leaf.



OO
Oro
Gold

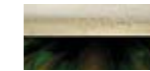

VA
Verde Antalia
Antalia Green



NN
Nero
Black

Finiture Finishings



OG
Oro Galvanizzato
Galvanized Gold







OF
Ottone Spazzolato Fine
Fine Brushed Brass

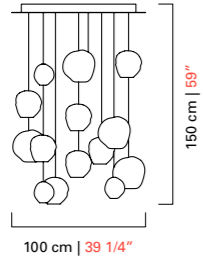
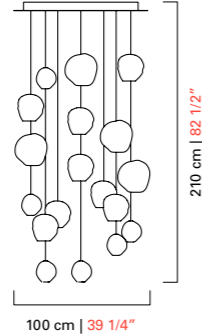
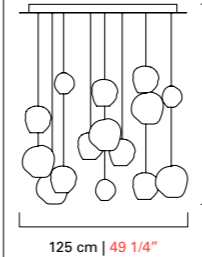
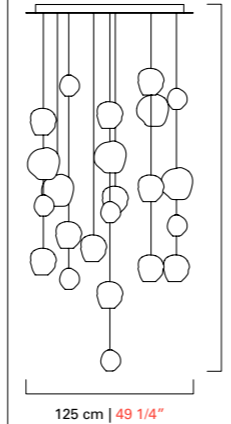

HANAMI

Come in un'opera d'arte moderna lo stesso elemento è ripetuto e moltiplicato quasi all'infinito. Una ripetizione seriale di una semplice forma modulare che genera un volume organico ed omogeneo. Ma in realtà ogni singola bolla non è mai perfettamente identica a sé stessa; la soffiatura e la lavorazione a mano rendono i multipli simili ma mai uguali rendendo unica ogni composizione.

As in a modern artwork, the same element is repeated and multiplied almost infinitely. The reiteration of a simple modular form generates an organic, homogenous volume. Actually, the individual bubbles are never quite the same; the glassblowing technique and handwork make the multiples similar but never equal, meaning that every composition is truly unique.

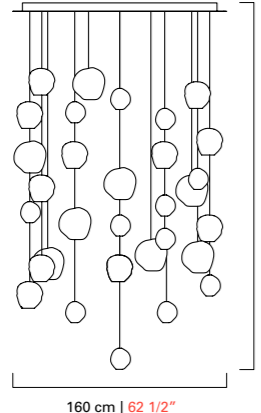

Modelli e misure <i>Models and sizes</i>	Hanami 7295	Hanami 7296	Hanami 7297	Hanami 7298
				
Peso Weight	47 kg 103 lb	53 kg 116 lb	75 kg 165 lb	100 kg 220 lb
Lampadine N. Tipo W max. Bulbs N. Type W max.	4+8 G9+GU10 20+20 4+5,3	4+8 G9+GU10 20+20 4+5,3	10+15 G9+GU10 20+20 4+5,3	10+15 G9+GU10 20+20 4+5,3
Dimmerabile Dimmable	D	D	D	D
Lampadine incluse Bulbs included	G9 Led + GU10 Led	G9 Led + GU10 Led	G9 Led + GU10 Led	G9 Led + GU10 Led
Certificazioni Certification Marks				

Modelli e misure <i>Models and sizes</i>	Hanami 7299
	
Peso Weight	140 kg 308 lb
Lampadine N. Tipo W max. Bulbs N. Type W max.	13+21 G9+GU10 20+20 4+5,3
Dimmerabile Dimmable	D
Lampadine incluse Bulbs included	G9 Led + GU10 Led
Certificazioni Certification Marks	

Colori disponibili
Available colours



CC
Cristallo
Crystal



IC
Grigio
Grey



EK
Sabbia
Sand



DK
Oliva
Olive



AK
Blu Cadetto
Cadet Blue



LQ
Bluastro
Bluastro



FK
Indaco
Indigo



CK
Pervinca
Periwinkle

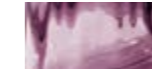

VI
Viola
Violet



OO
Oro
Gold

Finiture
Finishings



CL
Cromo Lucido
Polished Chrome

MANHATTAN





Alessandro Piva

Cornici in metallo sospese all'interno delle quali galleggiano bolle di cristallo veneziano soffiato proposte in due palette colori oppure bianche e cristallo trasparente. Tre diverse composizioni (uno, tre o quattro calate) e due altezze.

Suspended metal frames from where blown Venetian crystal bubbles float in the air. Available in two coloured palettes or in white and transparent version. Three different compositions (one, three or four steel cables), and two heights.

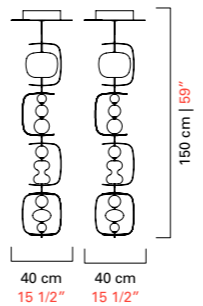
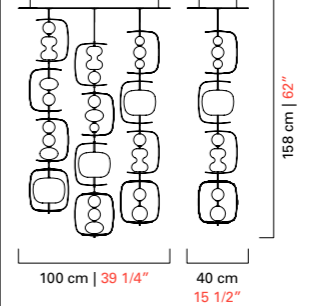
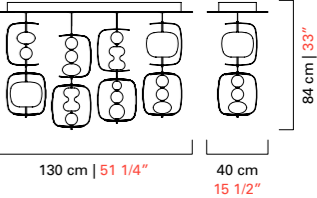

Modelli e misure Models and sizes

	Manhattan 7107	Manhattan 7108	Manhattan 7109
			
Peso Weight	14 kg 31 lb	39 kg 89 lb	37 kg 81 lb
Lampadine N. Tipo W max. Bulbs N. Type W max.	2 GU5.3 7 7	6 GU5.3 7 7	8 GU5.3 7 7
Dimmerabile Dimmable	D	D	D
Lampadine incluse Bulbs included	GU5.3 Led	GU5.3 Led	GU5.3 Led
Certificazioni Certification Marks			

Colori disponibili Available colours



BB
Bianco
White



CC
Cristallo
Crystal



LE
Bluastro / Bluino /
Acquamare / Grigio
Bluastro / Light
blue / Aquamarine
/ Grey



WN
Grigio / Brown /
Cognac / Bianco
Grey / Brown /
Cognac / White

Finiture Finishings



CN
Cromo Nero
Dark Chrome



OU
Oro Opaco
Matt Gold

MARTA

Una lampada a sospensione caratterizzata da sfere in cristallo veneziano allineate lavorate con la tradizionale tecnica a "corteccia". La massa vetrosa ancora calda viene fatta rotolare abilmente su di uno stampo piatto a lamelle e poi, successivamente, soffiata per ottenere una superficie irregolare e tridimensionale che ricorda quella della corteccia di un albero.

A suspension lamp featuring aligned spheres of Venetian crystal, crafted with the traditional "corteccia" technique. The hot glass is skilfully turned on a flat lamellar plate and then blown to obtain an irregular three-dimensional surface, resembling the bark of a tree.



Modelli e misure Models and sizes

Marta
5578

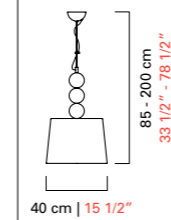

Peso Weight	8 kg 18 lb
Lampadine Bulbs	N. Tipo W max. 1 E27 100 N. Type W max. E26 60
Dimmerabile Dimmable	D
Lampadine incluse Bulbs included	
Certificazioni Certification Marks	UL ENEC UL US

Colori disponibili Available colours



CC
Cristallo
Crystal



IC
Grigio
Grey



EK
Sabbia
Sand



DK
Oliva
Olive



AK
Blu Cadetto
Cadet Blue



LQ
Bluastro
Bluastro



FK
Indaco
Indigo



CK
Pervinca
Periwinkle



VI
Viola
Violet



OO
Oro
Gold

Finiture Finishings



CL
Cromo Lucido
Polished Chrome



CN
Cromo Nero
Dark Chrome



OF
Ottone
Spazzolato Fine
Fine Brushed Brass

Paralumi Shades

Esterno: Cotone
External: Cotton



BB
Bianco
White

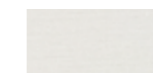

NN
Nero
Black



NO
Nero Interno Oro
Black Inner Gold



MATRIOSKA

Una collezione caratterizzata da una distribuzione in pianta lineare. Disposti lungo una montatura rettilinea oppure quadrata, i preziosi elementi in cristallo veneziano, chiamati "cipolle" per la loro particolare forma e per la lavorazione a costolature, diventano protagonisti di un'inusuale interpretazione della lampada a sospensione con paralumi.

A collection characterized by linear arrangements. Placed along a straight or square fitting, the precious elements in Venetian crystal, known as "cipolle" due to their particular form and ribbed workmanship, become the protagonists of an unusual interpretation of the suspension lamp with shades.



Modelli e misure <i>Models and sizes</i>	Matrioska 7097/02	Matrioska 7098/04
Peso Weight	6 kg 13 lb	14 kg 31 lb
Lampadine N. Tipo W max. Bulbs N. Type W max.	2 E27 60 E26 60	4 E27 60 E26 60
Dimmerabile Dimmable	D	D
Lampadine incluse Bulbs included		
Certificazioni Cerification Marks		

Modelli e misure <i>Models and sizes</i>	Matrioska 7097/05
Peso Weight	15 kg 33 lb
Lampadine N. Tipo W max. Bulbs N. Type W max.	5 E27 60 E26 60
Dimmerabile Dimmable	D
Lampadine incluse Bulbs included	
Certificazioni Cerification Marks	

Modelli e misure <i>Models and sizes</i>	Matrioska 7097/03	Matrioska 7097/04
Peso Weight	9 kg 20 lb	12 kg 26 lb
Lampadine N. Tipo W max. Bulbs N. Type W max.	3 E27 60 E26 60	4 E27 60 E26 60
Dimmerabile Dimmable	D	D
Lampadine incluse Bulbs included		
Certificazioni Cerification Marks		

Colori disponibili <i>Available colours</i>					
	CC Cristallo <i>Crystal</i>	IC Grigio <i>Grey</i>	EK Sabbia <i>Sand</i>	DK Oliva <i>Olive</i>	AK Blu Cadetto <i>Cadet Blue</i>
Finiture <i>Finishings</i>					
	LQ Bluastro <i>Bluastro</i>	FK Indaco <i>Indigo</i>	CK Pervinca <i>Periwinkle</i>	VI Viola <i>Violet</i>	OO Oro <i>Gold</i>
Paralumi Shades					
	Esterno: Cotone <i>External: Cotton</i>	BB Bianco <i>White</i>	NN Nero <i>Black</i>	NO Nero Interno Oro <i>Black Inner Gold</i>	

MEDINA

Una collezione formosa, con dimensioni generose dalle linee quasi boteriane.
Il collare metallico ed i paralumi fuori scala caratterizzano l'intera linea.

A shapely collection with generous dimensions whose design recalls somehow Botero's drawings. The metal neck and the oversize shades are distinctive of the entire line.



Modelli e misure Models and sizes

	Medina 5684/03	Medina 5684/05
	<p>120 cm 47 1/4"</p> <p>110 cm 43 1/4"</p>	<p>150 cm 59"</p> <p>110 cm 43 1/4"</p>
Peso Weight	23 kg 51 lb	32 kg 70 lb
Lampadine Bulbs	N. Tipo W max. 3 E27 100	N. Tipo W max. 5 E27 100
Dimmerabile Dimmable	D	D
Lampadine incluse Bulbs included		
Certificazioni Certification Marks		

Colori disponibili Available colours



CC
Cristallo
Crystal



IC
Grigio
Grey



EK
Sabbia
Sand



DK
Oliva
Olive



AK
Blu Cadetto
Cadet Blue



LQ
Bluastro
Bluastro



FK
Indaco
Indigo



CK
Pervinca
Periwinkle



VI
Viola
Violet



OO
Oro
Gold

Finiture Finishings



CL
Cromo Lucido
Polished Chrome



CN
Cromo Nero
Dark Chrome



OF
Ottone
Spazzolato Fine
Fine Brushed Brass

Paralumi Shades

Esterno: Cotone
External: Cotton



BB
Bianco
White



NN
Nero
Black



NO
Nero Interno Oro
Black Inner Gold

NEW EDEN

Daniela Puppa | Francesca Martelli

New Eden è una valle costellata di fiori e rovesciata sottosopra, che trasforma il concetto di lampadario tradizionale in un corpo chiuso, ricco di riflessi generati dalle decine di fiori in cristallo veneziano lavorato "a mano volante" e disposti su una calotta di metallo bianco; tutti i fiori sono in cristallo trasparente, tranne uno che dà l'accento al paralume che avvolge la lampada e che può essere posizionato ovunque.

New Eden is a valley dotted with flowers that has been turned upside down. It transforms the concept of a traditional chandelier with its closed body which is full of reflections that are generated by dozens of floating "hand-crafted" Venetian crystal flowers arranged on a white metal sphere. All of the flowers are made of transparent crystal, except for one which gives emphasis to the lampshade and can be positioned anywhere.



Modelli e misure Models and sizes	New Eden 7344	New Eden 7345	New Eden 7346
Peso Weight	15 kg 33 lb	22 kg 49 lb	32 kg 71 lb
Lampadine Bulbs	N. Tipo W max. 12+6 G4+Led 1,5+1	N. Tipo W max. 18+9 G4+Led 1,5+1	N. Tipo W max. 33+12 G4+Led 1,5+1
Dimmerabile Dimmable			
Lampadine incluse Bulbs included	G4 Led + Led	G4 Led + Led	G4 Led + Led
Certificazioni Cerification Marks	ERAC	ERAC	ERAC

Colori disponibili Available colours



IC
Grigio
Grey
*Solo con paralume GC
Only with GC shade



LQ
Bluastro
Blue
*Solo con paralume PT
Only with PT shade



VI
Viola
Violet
*Solo con paralume RS
Only with RS shade



BW
Brown
Brown
*Solo con paralume BE
Only with BE shade

Finiture Finishings



VG
Verniciato Bianco
Painted White

Paralumi Shades

Esterno: Cotone
External: Cotton



GC
Grigio
Grey
*Solo con IC
Only with IC



PT
Petrolio
Petrol Blue
*Solo con LQ
Only with LQ



RS
Rosa
Pink
*Solo con VI
Only with VI



BE
Beige
Beige
*Solo con BW
Only with BW



47 cm | 18 1/2"



70 cm | 27 1/2"



98 cm | 38 1/2"

NEW FELCI

Per immergersi in una suggestiva atmosfera dallo stile Déco, ammiccando al gusto glamour degli anni '20 e '30. Il fascino di una cascata di luce composta da brillanti e voluttuose foglie in cristallo veneziano delicatamente arricciate alle estremità.

For a plunge into an evocative Déco mood that takes its cue from the glamour of the 1920s and 1930s. The charm of a cascade of light composed of sparkling and voluptuous leaves of Venetian crystal, delicately curled at the extremities.



Modelli e misure <i>Models and sizes</i>	New Felci 7240	New Felci 7241	New Felci 7242	New Felci 7243
Peso Weight	28 kg 62 lb	60 kg 132 lb	100 kg 220 lb	94 kg 207 lb
Lampadine N. Tipo W max. Bulbs N. Type W max.	5 E14 40 E12 40	8+4 E14+E14 60+40 E12+E12 5+5	18+4 E14+E14 60+40 E12+E12 5+5	16+2 E14+G9 40+20 E12+G9 5+20
Dimmerabile Dimmable	D	D	D	D
Lampadine incluse Bulbs included				G9 Led
Certificazioni Cerification Marks	ERAC CCC	ERAC CCC cUL US	ERAC cUL US	ERAC CCC cUL US

Colori disponibili
Available colours



CC
Cristallo
Crystal

Finiture
Finishings



CL
Cromo Lucido
Polished Chrome



OG
Oro Galvanizzato
Galvanized Gold

Modelli e misure <i>Models and sizes</i>	New Felci 7246
Peso Weight	150 kg 330 lb
Lampadine N. Tipo W max. Bulbs N. Type W max.	28+2 E14+G9 40+20 E12+G9 5+20
Dimmerabile Dimmable	D
Lampadine incluse Bulbs included	G9 Led
Certificazioni Cerification Marks	ERAC cUL US



OPÉRA



Philippe Nigro

Opéra è una collezione di lampade ispirata all'Opéra Garnier, in cui l'elemento principale è la lavorazione del rostrato. La forma cilindrica va ad enfatizzare il motivo ornamentale, moltiplicando gli angoli di incidenza dei raggi luminosi e creando un fitto involuppo di punte tridimensionali. Alle creazioni in Cristallo Veneziano sono abbinati elementi metallici dalla silhouette molto affine, che circondano e sostengono i corpi luminosi. Le sospensioni Opéra sono disponibili in diverse varianti dimensionali, per sposare progetti di interior design di natura e portata differente: dagli spazi domestici fino ai grandi ambienti di rappresentanza e contract, dove è possibile realizzare delle vere e proprie installazioni personalizzate, con composizioni asimmetriche e multiformi.

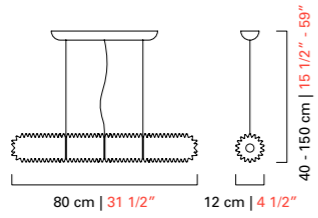
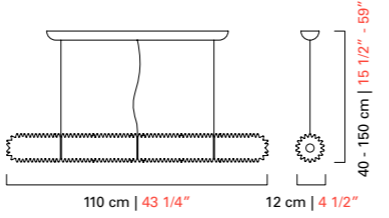
Opéra is a collection of lamps inspired by the Opéra Garnier, where the main feature is the rostrato. The cylindrical form underscores the ornamental motif, multiplying the angles of impact of beams of light and creating a dense wrapping of three-dimensional points. The creations in Venetian Crystal are joined by metal parts with a very similar silhouette, which surround and support the luminous volumes: completely different textures, sharing a specific inspiration in their shapes and substance. The Opéra suspension lamps are available in different sizes, ready to be utilized in interior design projects of different types and scales: from residential spaces to contract applications, where it is possible to organize true custom installations, with asymmetrical and multiform compositions.

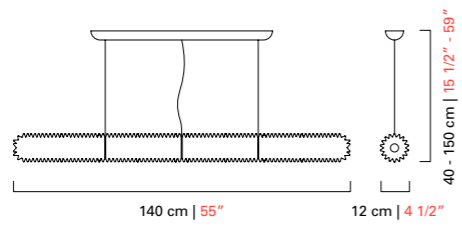

Modelli e misure <i>Models and sizes</i>		Opéra 7386	Opéra 7387
			
Peso Weight		12 kg 26 lb	15 kg 33 lb
Lampadine Bulbs	N. Tipo W max. N. Type W max.	1 Strip Led 30 30	1 Strip Led 38 38
Dimmerabile Dimmable		D	D
Lampadine incluse Bulbs included		Strip Led	Strip Led
Certificazioni Cerification Marks			

Modelli e misure <i>Models and sizes</i>		Opéra 7388
		
Peso Weight		18 kg 40 lb
Lampadine Bulbs	N. Tipo W max. N. Type W max.	1 Strip Led 45 45
Dimmerabile Dimmable		D
Lampadine incluse Bulbs included		Strip Led
Certificazioni Cerification Marks		

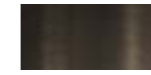
Colori disponibili
Available colours**CC**
Cristallo
*Crystal***Finiture**
Finishings**NJ**
Nickel Nero
Spazzolato
*Brushed Black
Nickel***OJ**
Oro Spazzolato
Brushed Gold





PADMA

Collezione disegnata per esprimere armonia, sintesi tra le parti, sinergia tra contrasti. A confrontarsi sono innovazione e tradizione, attraverso il rapporto tra design e tecniche di lavorazione, attinte allo storico patrimonio conoscitivo dell'azienda. Insolite commistioni generano un suggestivo dialogo tra elementi racchiusi l'uno nell'altro, diversi tra loro per forma, cromia, lavorazione, ma fortemente connessi dal design dell'oggetto.

This collection is designed to express harmony, a synthesis of parts, a synergy of contrasts. The balance of innovation and tradition, through the relationship between design and techniques of workmanship, drawing on the company's heritage of know-how. Unusual mixtures generate an evocative dialogue between parts nestled one inside the other, different in form, hue, workmanship, but forcefully connected by the design of the object.

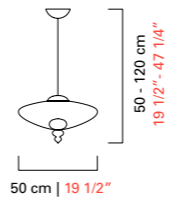
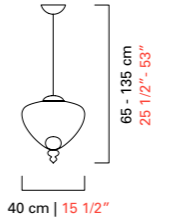
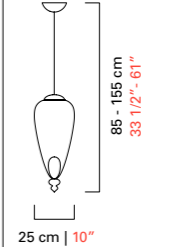
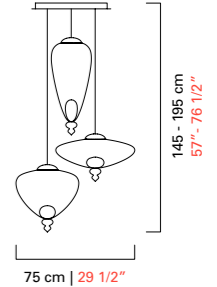



Modelli e misure <i>Models and sizes</i>	Padma 7379	Padma 7381	Padma 7383	Padma 7384
				
Peso <i>Weight</i>	7 kg 15 lb	7 kg 15 lb	7 kg 15 lb	22 kg 48 lb
Lampadine N. Tipo W max. Bulbs N. Type W max.	1 Led 10 1 Led 10	1 Led 10 1 Led 10	1 Led 10 1 Led 10	3 Led 10 3 Led 10
Dimmerabile <i>Dimmable</i>	D	D	D	D
Lampadine incluse <i>Bulbs included</i>	Led	Led	Led	Led
Certificazioni <i>Cerification Marks</i>				

Colori disponibili

Available colours

Diffusore
Diffuser



BB
Bianco Sfumato
Shaded White

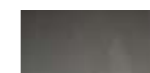

IC
Grigio Sfumato
Shaded Grey

Colori disponibili

Available colours

Dettaglio decorativo
Decorative detail



CC
Cristallo
Crystal



BB
Bianco
White



IC
Grigio
Grey



EK
Sabbia
Sand



DK
Oliva
Olive



LQ
Bluastro
Bluastro



FK
Indaco
Indigo



CK
Pervinca
Perwinkle



OO
Oro
Gold



NN
Nero
Black

Finiture

Finishings



NJ
Nickel nero
spazzolato
*Brushed Black
Nickel*



OJ
Oro Spazzolato
Brushed Gold

PALMETTE

Una collezione che si distingue per la preziosità delle lavorazioni, rigorosamente realizzate artigianalmente e frutto di una ricerca stilistica che attinge alla storia per darne una interpretazione in chiave contemporanea. Ventagli in foglie di cristallo, sovrapposti a formare due, tre e quattro livelli per una rilettura intrigante dello stile déco.

A collection that stands out for precious workmanship rigorously done by hand, result of stylistic research that draws on history, granting it a contemporary interpretation. Fans of crystal leaves, placed to form two, three and four levels, for an intriguing take on Art Deco.



Modelli e misure <i>Models and sizes</i>	Palmette 7385/4	Palmette 7385/5	Palmette 7385/6	Palmette 7385/7
Peso Weight	19 kg 42 lb	30 kg 66 lb	60 kg 132 lb	45 kg 99 lb
Lampadine N. Tipo W max. Bulbs N. Type W max.	6 E27 60 E26 40	6 E27 60 E26 40	16 E27 60 E26 40	11 E27 60 E26 40
Dimmerabile Dimmable	D	D	D	D
Lampadine incluse Bulbs included				
Certificazioni Cerification Marks	ERC	ERC	ERC	ERC

Modelli e misure <i>Models and sizes</i>	Palmette 7385/16
Peso Weight	60 kg 132 lb
Lampadine N. Tipo W max. Bulbs N. Type W max.	15 E27 60 E26 40
Dimmerabile Dimmable	D
Lampadine incluse Bulbs included	
Certificazioni Cerification Marks	ERC

Modelli e misure <i>Models and sizes</i>	Palmette 7385/9	Palmette 7385/12	Palmette 7385/13	Palmette 7385/14
Peso Weight	27 kg 59 lb	110 kg 242 lb	27 kg 59 lb	60 kg 132 lb
Lampadine N. Tipo W max. Bulbs N. Type W max.	6 E14 60 E12 40	28 E27 60 E26 40	6+6 E14 60+40 E12 40	17 E27 60+40 E26 40
Dimmerabile Dimmable	D	D	D	D
Lampadine incluse Bulbs included				
Certificazioni Cerification Marks	ERC	ERC	ERC	ERC

Colori disponibili
Available colours



CC
Cristallo
Crystal

Finiture
Finishings



CL
Cromo Lucido
Polished Chrome



OG
Oro Galvanizzato
Galvanized Gold

PALMYRA

Fabio Calvi | Paolo Brambilla

Una sospensione molto leggera, caratterizzata da linee sinuose, in grado di impreziosire e di illuminare qualunque ambiente. È composta da bracci sovrapposti dal profilo curvilineo, dai quali pendono molteplici elementi di vetro ritorto realizzati con la stessa lavorazione dei "pastorali" dell'antica tradizione vetraria muranese.

Palmyra is a very light suspension, characterized by sinuous lines, able to embellish and illuminate any environment. It is composed by overlapped arms with curved profiles, from which hang twisted crystal elements, made following the "pastoral" processing of the ancient Murano glass tradition.

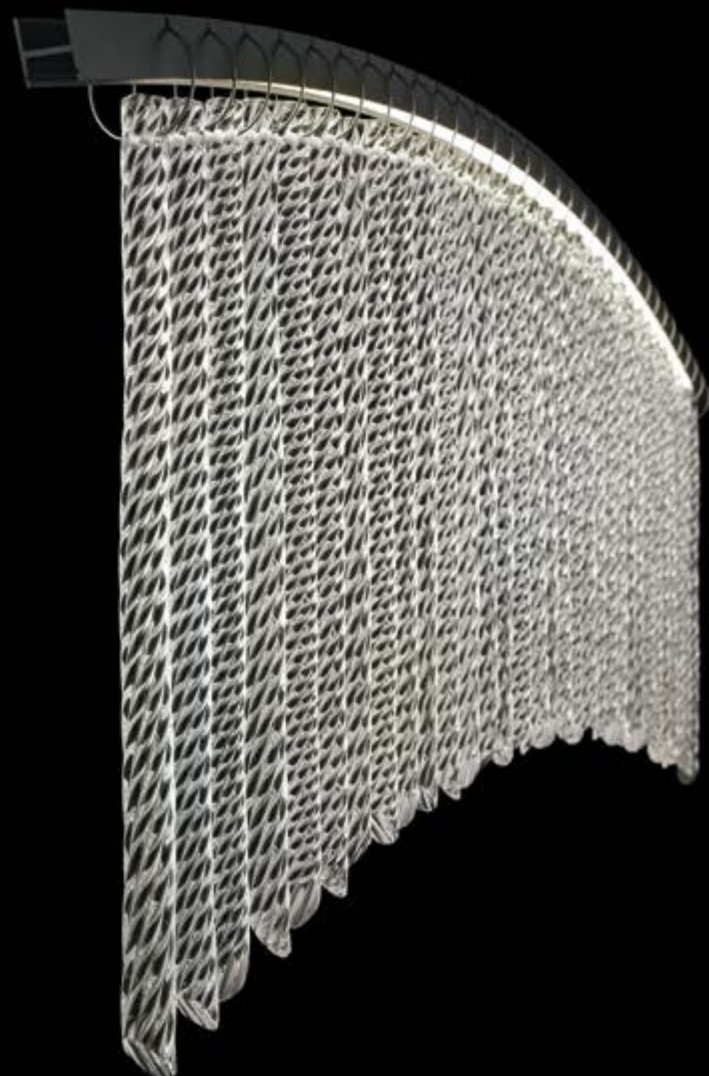

Modelli e misure
Models and sizes

Palmyra 7270		Palmyra 7271	
Peso Weight	19 kg 42 lb	55 kg 121 lb	
Lampadine N. Tipo W max. Bulbs N. Type W max.	1 Strip Led 60 60	3 Strip Led 60 60	
Dimmerabile Dimmable			
Lampadine incluse Bulbs included	Strip Led	Strip Led	
Certificazioni Certification Marks			

Modelli e misure
Models and sizes

Palmyra 7274	
Peso Weight	78 kg 172 lb
Lampadine N. Tipo W max. Bulbs N. Type W max.	1+2+1 Strip Led 40+60+80 40+60+80
Dimmerabile Dimmable	
Lampadine incluse Bulbs included	Strip Led
Certificazioni Certification Marks	

Modelli e misure
Models and sizes

Palmyra 7272		Palmyra 7273	
Peso Weight	55 kg 121 lb	72 kg 158 lb	
Lampadine N. Tipo W max. Bulbs N. Type W max.	1+1+1 Strip Led 40+60+80 40+60+80	4 Strip Led 60 60	
Dimmerabile Dimmable			
Lampadine incluse Bulbs included	Strip Led	Strip Led	
Certificazioni Certification Marks			

Colori disponibili
Available colours

CC
 Cristallo
 Crystal

Finiture
Finishings

AA
 Anodizzato Argento
 Anodized Silver

AN
 Anodizzato Nero
 Anodized Black

Anelli
Rings

IN
 Inox
 Inox

OG
 Oro Galvanizzato
 Galvanized Gold





PANDORA

Regala leggerezza ed un aspetto fiabesco agli interni grazie ai bracci in cristallo veneziano che sembrano fluttuare nell'aria. Il suo aspetto simile a quello di una medusa crea divertenti giochi di luce che donano profondità agli ambienti, ed il suo paralume di dimensioni importanti genera un'illuminazione omogenea ed elegante.

Interiors take on a light, fairy-tale image thanks to arms of Venetian crystal that seem to float in the air. The resemblance to a jellyfish suggests playful games of light that add depth to spaces, while the large shade generates uniform, elegant light.

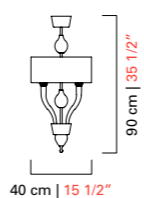
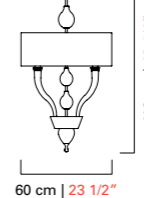
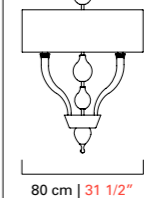

Modelli e misure Models and sizes

	Pandora 5675/05	Pandora 5675/08	Pandora 5675/10
			
Peso Weight	6 kg 13 lb	10 kg 22 lb	14 kg 31 lb
Lampadine Bulbs	N. Tipo W max. 5+1 E14+Led 60+1,2 E12+Led	N. Tipo W max. 8+1 E14+Led 60+1,2 E12+Led	N. Tipo W max. 10+1 E14+Led 60+1,2 E12+Led
Dimmerabile Dimmable	D E14	D E14	D E14
Lampadine incluse Bulbs included	Led	Led	Led
Certificazioni Certification Marks			

Colori disponibili Available colours



CC
Cristallo
Crystal



IC
Grigio
Grey



EK
Sabbia
Sand



DK
Oliva
Olive



AK
Blu Cadetto
Cadet Blue



LQ
Bluastro
Bluastro



FK
Indaco
Indigo

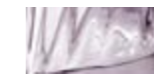

CK
Pervinca
Periwinkle



VI
Viola
Violet



OO
Oro
Gold

Finiture Finishings



CL
Cromo Lucido
Polished Chrome



CN
Cromo Nero
Dark Chrome

Paralumi Shades

Esterno: Cotone
External: Cotton



40 cm | 15 1/2"



60 cm | 23 1/2"



80 cm | 31 1/2"

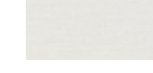

BB
Bianco
White

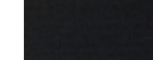

NN
Nero
Black



NO
Nero Interno Oro
Black Inner Gold

PERSEUS

Marcel Wanders Studio

Una sospensione che si presenta come una strabiliante esplosione di cristallo veneziano, sapientemente equilibrata nei volumi, nell'alternarsi delle diverse cromie, nel gioco asimmetrico dei bracci. Perseus è composta da un gran numero di elementi in cristallo che rappresentano quasi un compendio delle tecniche vetrarie studiate e sviluppate da Barovier&Toso nel corso della sua lunga storia, qui reinterpretate, accostate e mescolate in modo sovversivo rispetto ai canoni della classicità.

This suspension looks like a dazzling explosion of Venetian crystal, carefully balanced in volume, in the alternation of different colours, in the asymmetrical game of the arms. Perseus is composed of a large number of crystal elements that represent a compendium of the glassmaking techniques studied and developed by Barovier&Toso in the course of its long history, here reinterpreted, paired, and mixed in a subversive way with respect to the canons of classicism.



Modelli e misure Models and sizes

	Perseus 7265	Perseus 7310	Perseus 7311
Peso Weight	40 kg 88 lb	4 kg 9 lb	7 kg 15 lb
Lampadine Bulbs	N. Tipo W max. 15 G4 5	1 E14 40 E12 40	1 E14 40 E12 40
Dimmerabile Dimmable		D	D
Lampadine incluse Bulbs included	G4 Led		
Certificazioni Certification Marks	UL ENEC c UL us	UL ENEC c UL us	UL ENEC c UL us

Colori disponibili Available colours



***WP**
Cristallo / Grigio /
Brown / Cognac /
Bianco
Crystal / Grey /
Brown / Cognac /
White
*Solo 7265
Only 7265



***WR**
Cristallo / Bianco /
Cognac / Bluastro
Crystal / White /
Cognac / Bluastro
*Solo 7265
Only 7265



***WZ**
Cristallo /
Cedro liquido /
Acquamare /
Grigio / Bianco
Crystal /
Liquid Citron /
Aquamarine /
Grey / White
*Solo 7265
Only 7265



***WQ**
Bianco / Cristallo /
Grigio /
Cedro Liquido
White / Crystal /
Grey / Liquid Citron
*Solo 7310 / 7311
Only 7310 / 7311



***WS**
Bianco / Cristallo /
Cognac / Brown
White / Crystal /
Cognac / Brown
*Solo 7310 / 7311
Only 7310 / 7311

Finiture Finishings



CL
Cromo Lucido
Polished Chrome



PIGALLE

Tradizione ed innovazione si fondono in questa collezione ispirata alla Belle Époque. Si caratterizza per eleganza e linee sinuose senza risultare eccessiva ed ostentata. Eloquente per raffinatezza e grazia alterna linee semplici, dettagli curvi e lavorazioni tradizionali.

Tradition and innovation blend in this collection inspired by the Belle Époque. It stands out for its elegant, sinuous lines, without ever seeming excessive or ostentatious. With its eloquent refinement and grace, it mixes simple lines, curved details and traditional workmanship.

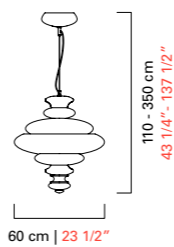
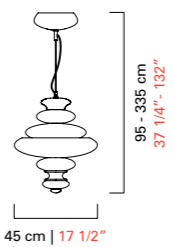

Modelli e misure Models and sizes

	Pigalle 5692	Pigalle 5693
		
Peso Weight	11 kg 24 lb	8 kg 18 lb
Lampadine Bulbs	N. Tipo W max. 6 E14 60 E12 60	3 E14 60 E12 60
Dimmerabile Dimmable	D	D
Lampadine incluse Bulbs included		
Certificazioni Certification Marks		

Colori disponibili Available colours



CC
Cristallo
Crystal

Finiture Finishings



CL
Cromo Lucido
Polished Chrome



CN
Cromo Nero
Dark Chrome

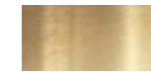





OJ
Oro Spazzolato
Brushed Gold

PIUME

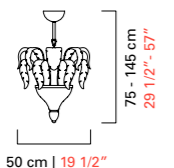
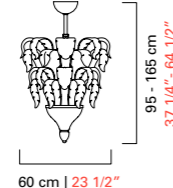
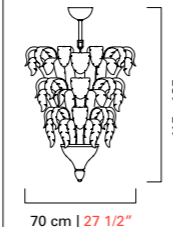
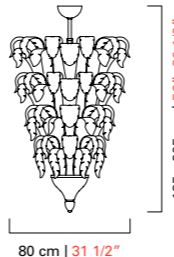

Riprese dai disegni degli anni '20 e '30 del nostro archivio storico, queste sospensioni sono un omaggio allo stile Déco. Con le loro ricche piume evocano ambientazioni lussuose e ricercate. Adatte ad ambienti estremamente decorati come anche, per contrasto, ad interni più minimali.

Resumed from drawings of the 20ies and 30ies from our historical archive, these suspensions pay a tribute to the Déco era. With their rich feathers they evoke luxurious and refined settings. Perfect for extremely decorated ambiences as well as, playing with contrasts, for more minimal interior design projects.

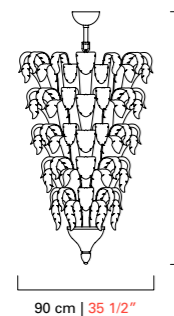

Modelli e misure <i>Models and sizes</i>	Piume 5393	Piume 5394	Piume 5395	Piume 5396
	 75 - 145 cm 29 1/2" - 57" 50 cm 19 1/2"	 95 - 165 cm 37 1/4" - 64 1/2" 60 cm 23 1/2"	 115 - 185 cm 45 1/4" - 72 1/2" 70 cm 27 1/2"	 135 - 205 cm 53" - 80 1/2" 80 cm 31 1/2"
Peso Weight	18 kg 40 lb	48 kg 106 lb	57 kg 125 lb	80 kg 176 lb
Lampadine N. Tipo W max. Bulbs N. Type W max.	4 E14 60 E12 60	8 E14 40 E12 40	8+5 E27+E14 60+40 E26+E12 60+40	13+4 E27+E14 60 E26+E12 60
Dimmerabile Dimmable	D	D	D	D
Lampadine incluse Bulbs included				
Certificazioni Certification Marks				

Colori disponibili
Available colours**OB**
Oro Beige
Beige Gold**Finiture**
Finishings**OG**
Oro Galvanizzato
Galvanized Gold

Modelli e misure <i>Models and sizes</i>	Piume 5397
	 170 - 240 cm 67" - 94 1/4" 90 cm 35 1/2"
Peso Weight	100 kg 220 lb
Lampadine N. Tipo W max. Bulbs N. Type W max.	18+4 E27+E14 60+40 E26+E12 60+40
Dimmerabile Dimmable	D
Lampadine incluse Bulbs included	
Certificazioni Certification Marks	

REX

Un grande fiore che fluttua nell'aria. Petali preziosi ed elaborati che grazie all'utilizzo della tecnica della "rugiada" sembrano dei merletti fatti a mano. Sospensioni spesso scelte all'inizio del '900 per grandi progetti di navi da crociera e alberghi di lusso sono ancora oggi dei pezzi unici capaci di donare un tocco retrò anche a progetti più contemporanei.

A large flower that floats in the air. Precious and elaborated petals that thanks to the "rugiada" technique seem handmade laces. These suspensions lamps were very common at the beginning of the 20th century in big cruises and luxury hotels projects but nowadays they are still unique pieces capable to give a retrò touch also to more contemporary projects.



Modelli e misure Models and sizes

	Rex 5359	Rex 5360
Peso Weight	22 kg 48 lb	32 kg 70 lb
Lampadine Bulbs	N. Tipo W max. 9+2 E14 60+40 N. Type W max. E12 60+40	12 E14 60 E12 60
Dimmerabile Dimmable	D	D
Lampadine incluse Bulbs included		
Certificazioni Certification Marks		

Colori disponibili Available colours



CR
Cristallo Rugiada
Crystal Rugiada



GR
Champagne Rugiada
Champagne Rugiada



OR
Oro Rugiada
Gold Rugiada

Finiture Finishings



OF
Ottone Spazzolato Fine
Fine Brushed Brass

ROBIN

Interpretazione moderna dell'archetipo della lanterna. Il disegno è pulito, minimale e rigoroso ma anche immediato: dà vita ad una forma che univocamente ci rammenta la remota foggia e l'antica funzione dell'iconica lampada. Le ali metalliche formano una maglia strutturale che abbraccia il diffusore in vetro opalino che illuminato genera un effetto luminoso caldo e soffuso.

A modern interpretation of the lantern archetype. The design is clean, minimal and rigorous, but also immediate: it generates a form that instantly reminds us of the age-old shape and original function of the iconic lamp. The metal wings form a structure that embraces the diffuser in opaline glass, which spreads a warm, soft glow into the space.



Modelli e misure Models and sizes

	Robin 7280	Robin 7281
Peso Weight	15 kg 33 lb	17 kg 37 lb
Lampadine Bulbs	N. Tipo/Type W max. 1+6+1 Led + G4 + Strip Led 2,3+5+1,9	1+6+1 Led + G4 + Strip Led 2,3+5+1,9
Dimmerabile Dimmable		
Lampadine incluse Bulbs included	Led + G4 Led + Strip Led	Led + G4 Led + Strip Led
Certificazioni Certification Marks	ERAC	ERAC

Colori disponibili Available colours



CC
Cristallo
Crystal



IC
Grigio
Grey



EK
Sabbia
Sand



DK
Oliva
Olive



AK
Blu Cadetto
Cadet Blue



LQ
Bluastro
Bluastro



FK
Indaco
Indigo

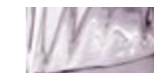

CK
Perivinka
Periwinkle



VI
Viola
Violet



OO
Oro
Gold

Finiture Finishings



CL
Cromo Lucido
Polished Chrome



ZO
Bronzo Satinato
Satinized Bronze

SAMURAI

Angelo Barovier

Angelo Barovier, nel 1966, progettava una lampada con costolature che successivamente è stata ripresa, ingigantita, messa sotto sopra e moltiplicata, fino ad ottenere un oggetto dalle dimensioni generose. Il disegno è caratterizzato da linee piramidali che fanno pensare ad un Samurai in posizione di riposo. Il cristallo veneziano con cui è realizzata è molto massiccio e la sua esecuzione richiede la mano e la forza di un esperto maestro vetraio.

Angelo Barovier had an idea for a ribbed lamp in 1966. Then his design was revisited, but this time inverted, repeated and created on a giant scale. Its pyramid shape recalls of a Samurai at rest. The Venetian crystal used for this piece is extremely massive, and working it requires the skill and strength of an experienced master glassmaker.



Modelli e misure Models and sizes

Samurai
7053

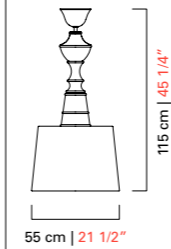

Peso Weight

15 kg
33 lb

Lampadine Bulbs

N.	Tipo	W max.
3	E14	60
	E12	60

Dimmerabile Dimmable

D

Lampadine incluse Bulbs included

Certificazioni Certification Marks



Colori disponibili Available colours



CC
Cristallo
Crystal



IC
Grigio
Grey



EK
Sabbia
Sand



DK
Oliva
Olive



AK
Blu Cadetto
Cadet Blue



LQ
Bluastro
Bluastro



FK
Indaco
Indigo



CK
Pervinca
Periwinkle



VI
Viola
Violet



OO
Oro
Gold

Finiture Finishings



CN
Cromo Nero
Dark Chrome



OF
Ottone
Spazzolato Fine
Fine Brushed Brass

Paralumi Shades

Esterno: Cotone
External: Cotton



BB
Bianco
White

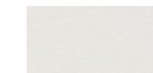

NN
Nero
Black



NO
Nero Interno Oro
Black Inner Gold

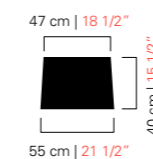



SPADE

Collezione di sospensioni ispirata ai fiori e alla natura che si contraddistingue per il suo delicato design a forma di corolla, realizzata con la tecnica della "rugiada" che dona un raffinato effetto ricamato. Due o tre livelli di petali si sovrappongono come a formare dei fiori schiusi, sospesi nell'aria.

A collection of suspensions with an accent on flowers and nature, which stands out for its delicate design in the form of a corolla, made with the "rugiada" technique to create a refined embroidered look. Two or three levels of petals overlap to form the image of a blossoming flower, suspended in the air.

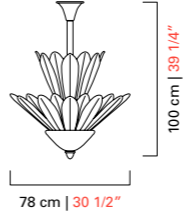
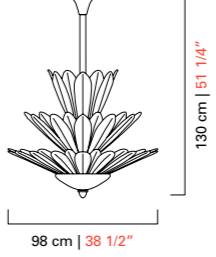

Modelli e misure Models and sizes

	Spade 6746	Spade 6743
		
Peso Weight	53 kg 117 lb	90 kg 198 lb
Lampadine Bulbs	N. Tipo W max. 9+2 E14 60+40	N. Tipo W max. 15+3 E14 60+40
Dimmerabile Dimmable	D	D
Lampadine incluse Bulbs included		
Certificazioni Certification Marks		

Colori disponibili Available colours



CR
Cristallo Rugiada
Crystal Rugiada

Finiture Finishings



CL
Cromo Lucido
Polished Chrome



OG
Oro Galvanizzato
Galvanized Gold







OF
Ottone
Spazzolato Fine
Fine Brushed Brass

SPINN



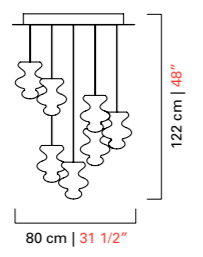
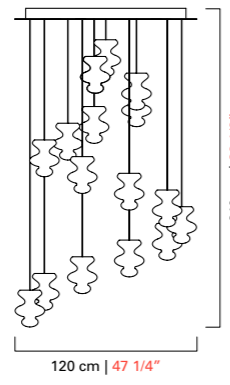
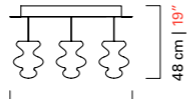
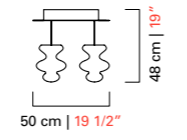
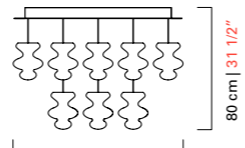
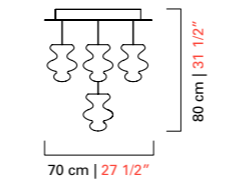

La "bambolina" è un elemento utilizzato nei lampadari della tradizione muranese. Nella collezione Spinn, tante bamboline disposte a spirale e illuminate dall'interno formano un vortice luminoso che decora l'ambiente con disegni e ombre, grazie alla tipica lavorazione del vetro detta "a balotòn".

The "bambolina" is an element used in chandeliers of the Muranese tradition. Spirally arranged and internally lit form a bright swirl which adorns the setting with designs and shadows thanks to the typical glass working called "a balotòn" (giving a cross-relief effect on glass).

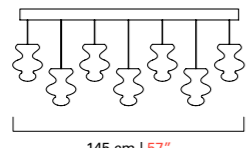

Modelli e misure <i>Models and sizes</i>	Spinn 7218	Spinn 7219	Spinn 7220	Spinn 7221
			 	 
Peso Weight	25 kg 55 lb	55 kg 121 lb	23 kg 51 lb	45 kg 99 lb
Lampadine N. Tipo W max. Bulbs N. Type W max.	5+7 GU5.3+G4 7+5 7+5	9+16 GU5.3+G4 7+5 7+5	5+6 GU5.3+G4 7+5 7+5	8+15 GU5.3+G4 7+5 7+5
Dimmerabile Dimmable	D	D	D	D
Lampadine incluse Bulbs included	GU5.3 Led + G4 Led	GU5.3 Led + G4 Led	GU5.3 Led + G4 Led	GU5.3 Led + G4 Led
Certificazioni Certification Marks				

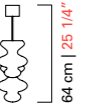
Colori disponibili
Available colours**CC**
Cristallo
Crystal**CG**
Cognac
Cognac**OO**
Oro
*Gold***Finiture**
Finishings**CL**
Cromo Lucido
Polished Chrome

Modelli e misure <i>Models and sizes</i>	Spinn 7222
	  
Peso Weight	14 kg 31 lb
Lampadine N. Tipo W max. Bulbs N. Type W max.	6+7 GU5.3+G4 7+5 7+5
Dimmerabile Dimmable	D
Lampadine incluse Bulbs included	GU5.3 Led + G4 Led
Certificazioni Certification Marks	

SWING

L'elemento base che compone Swing è un elegante cristallo veneziano lavorato "a balotòn" che dona a questa collezione una meravigliosa dinamicità e una stupefacente presenza scenica. Sostenuti da fini cavi di acciaio fissati alla sottile struttura a soffitto, questi elementi compongono figure delicatamente sinuose e ondeggianti sia in forma circolare che in forma libera.

The basic feature of Swing is an elegant piece of crafted Venetian crystal with the "a balotòn" technique, that gives the collection exceptional dynamism and a striking theatrical presence. Supported by slender steel cables attached to a thin structure on the ceiling, these parts form delicately sinuous and wavering figures, in circular or free-form configurations.

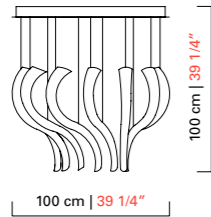
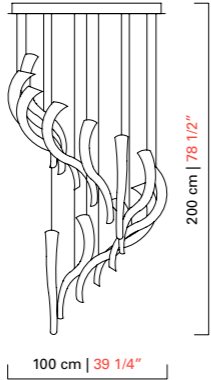
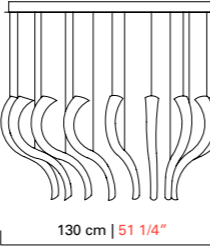
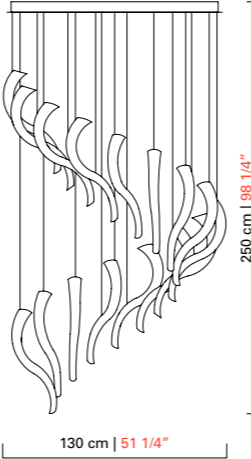

Modelli e misure Models and sizes	Swing 7323		Swing 7324		Swing 7325		Swing 7326			
		100 cm 39 1/4"	100 cm 39 1/4"		100 cm 39 1/4"	200 cm 78 1/2"		130 cm 51 1/4"		130 cm 51 1/4"
Peso Weight	45 kg 99 lb		45 kg 99 lb		63 kg 138 lb		63 kg 138 lb			
Lampadine N. Tipo W max. Bulbs N. Type W max.	6+1 GU10 + Strip Led 20+34		6+1 GU10 + Strip Led 20+34		8+1 GU10 + Strip Led 20+52		8+1 GU10 + Strip Led 20+52			
Dimmerabile Dimmable	D		D		D		D			
Lampadine incluse Bulbs included	GU10 Led + Strip Led		GU10 Led + Strip Led		GU10 Led + Strip Led		GU10 Led + Strip Led			
Certificazioni Cerification Marks	ERAC		ERAC		ERAC		ERAC			

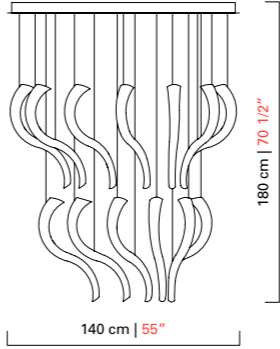
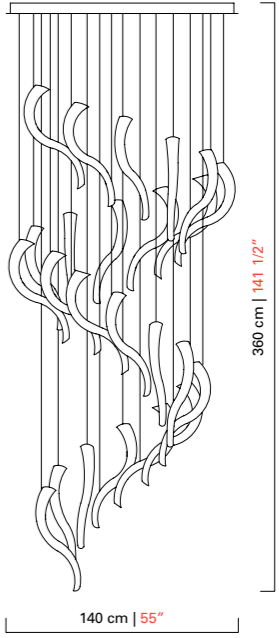
Modelli e misure Models and sizes	Swing 7327		Swing 7328		
		140 cm 55"	180 cm 70 1/2"		140 cm 55"
Peso Weight	85 kg 187 lb		85 kg 187 lb		
Lampadine N. Tipo W max. Bulbs N. Type W max.	12+1 GU10 + Strip Led 20+42		12+1 GU10 + Strip Led 20+42		
Dimmerabile Dimmable	D		D		
Lampadine incluse Bulbs included	GU10 Led + Strip Led		GU10 Led + Strip Led		
Certificazioni Cerification Marks	ERAC		ERAC		

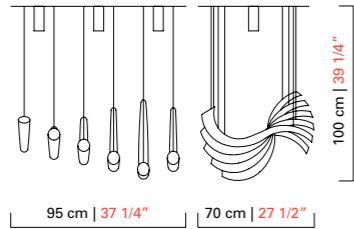
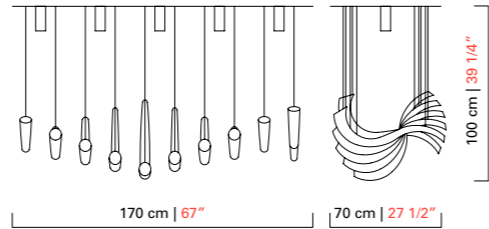
Modelli e misure Models and sizes	Swing 7329		Swing 7330		
		95 cm 37 1/4"	100 cm 39 1/4"		170 cm 67"
Peso Weight	12 kg 26 lb		19 kg 42 lb		
Lampadine N. Tipo W max. Bulbs N. Type W max.	3 GU10 20		5 GU10 20		
Dimmerabile Dimmable	D		D		
Lampadine incluse Bulbs included	GU10 Led		GU10 Led		
Certificazioni Cerification Marks	ERAC		ERAC		

Colori disponibili Available colours	CC	IC	EK	DK	AK
	Cristallo Crystal		Grigio Grey		Sabbia Sand
	Oliva Olive		Blu Cadetto Cadet Blue		
	Bluastro Bluastro		Indaco Indigo		Pervinca Periwinkle
	Viola Violet		Oro Gold		

Finiture Finishings	CL
	Cromo Lucido Polished Chrome

TRIM

Questa collezione attinge dall'archivio delle grandi installazioni realizzate da Barovier&Toso negli anni '60 e '70 attraverso la moltiplicazione e ripetizione di elementi modulari a canne o a poliedri, lisci o arricchiti dalle tradizionali lavorazioni muranesi. L'elemento esagonale realizzato con l'antica tecnica detta "ghiaccio" genera volumi sferici che perfettamente si integrano nell'architettura degli spazi diventandone quasi un'estensione. La posizione dei moduli può essere personalizzata al momento dell'installazione secondo il proprio estro: un ordine simmetrico e regolare oppure una forma disordinata.

The collection builds on the archive of large installations made by Barovier&Toso in the 1960s and 1970s, multiplying and repeating modular elements, simple or polyhedral, smooth or enhanced by traditional Murano workmanship. The hexagonal tube made with the age-old "ice" technique generates spherical volumes that fit perfectly into the architecture of spaces, almost becoming its extension. According to your own creativity, the position of the modules can be customized during installation into a symmetrical and conventional order or into a messy shape.



Modelli e misure Models and sizes

	Trim 7321	Trim 7322
Peso Weight	32 kg 70 lb	75 kg 165 lb
Lampadine Bulbs	N. Tipo W max. 7 Led 12 8	N. Tipo W max. 16 Led 12 8
Dimmerabile Dimmable	D	D
Lampadine incluse Bulbs included	Led	Led
Certificazioni Certification Marks		

Colori disponibili Available colours



CC
Cristallo
Crystal

Finiture Finishings



CL
Cromo Lucido
Polished Chrome



CN
Cromo Nero
Dark Chrome



OF
Ottone
Spazzolato Fine
Fine Brushed Brass

VALLONNÉ

Luca Nichetto

Vallonné è una collezione di lampade a sospensione in cristallo veneziano lavorato a mano e soffiato artigianalmente. Azione/reazione, espansione/contenimento: è in questo sistema di forze e di tensioni che nasce l'idea del progetto, dove la superficie dell'oggetto rivela una trama precisa di linee e di incisioni, facendo emergere una sequenza di rigonfiamenti dalle geometrie diverse. Nella collezione Vallonné, le lampade sono in cristallo trasparente e mostrano, all'interno, un'anima affusolata di vetro che nasconde la sorgente luminosa.

Vallonné is a collection of suspension lamps in Venetian Crystal, mouth blown and crafted by hand. Action/reaction, expansion/retraction: the idea of the design stems from this system of forces and tensions, where the surfaces of the object reveal a precise pattern of lines and incisions, bringing out a sequence of expansions through various geometric shapes. In the Vallonné collection, the lamps are in transparent crystal and contain a tapered core of glass that conceals the light source.



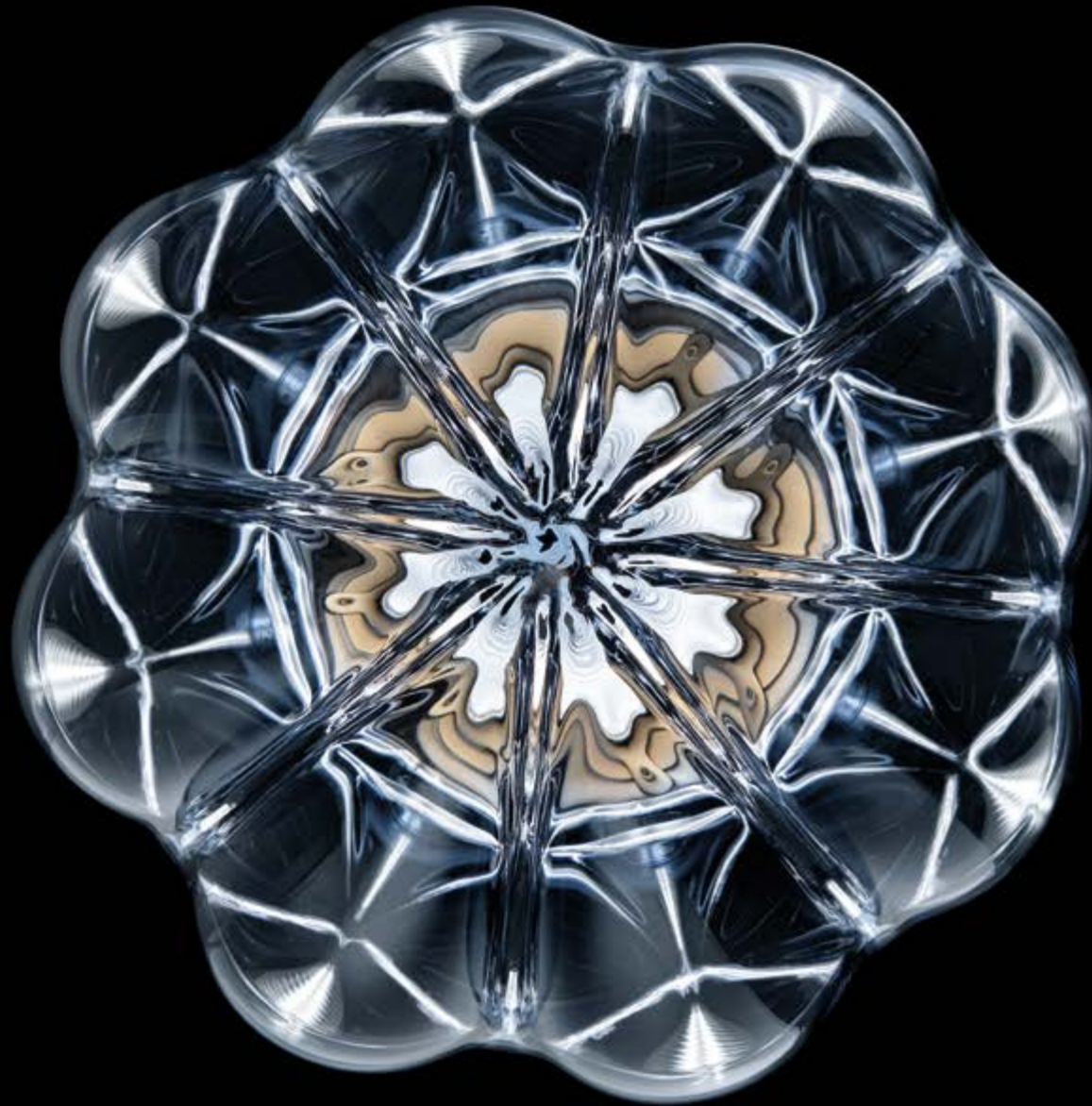

Modelli e misure
Models and sizes

	Vallonné 7394	Vallonné 7398
Peso Weight	9 kg 20 lb	9 kg 20 lb
Lampadine N. Tipo W max. Bulbs N. Type W max.	1 Led 10 10	1 Led 10 10
Dimmerabile Dimmable	D	D
Lampadine incluse Bulbs included	Strip Led	Strip Led
Certificazioni Certification Marks		

Colori disponibili
Available colours

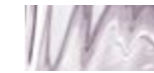
CC
 Cristallo
Crystal

FK
 Indaco
Indigo

CK
 Pervinca
Periwinkle

EK
 Sabbia
Sand
Finiture
Finishings

CN
 Cromo Nero
Dark Chrome

OZ
 Bronzo Miele
Honey Bronze

VALLONNÉ OPALE

Luca Nichetto

Vallonné Opale è una collezione di lampade a sospensione in cristallo veneziano lavorato a mano e soffiato artigianalmente. Azione/reazione, espansione/contenimento: è in questo sistema di forze e di tensioni che nasce l'idea del progetto, dove la superficie dell'oggetto rivela una trama precisa di linee e di incisioni, facendo emergere una sequenza di rigonfiamenti dalle geometrie diverse. Vallonné Opale, realizzata con la tecnica del vetro incamiciato, presenta esternamente un effetto opalino e lattiginoso che diffonde morbidamente la luce.

Vallonné Opale is a collection of suspension lamps in Venetian Crystal, mouth blown and crafted by hand. Action/reaction, expansion/retraction: the idea of the design stems from this system of forces and tensions, where the surfaces of the object reveal a precise pattern of lines and incisions, bringing out a sequence of expansions through various geometric shapes. Vallonné Opale is made with the jacketing technique, with an opaline, milky external effect that spreads light gently.



Modelli e misure Models and sizes

	Vallonné Opale 7395	Vallonné Opale 7399
Peso Weight	9 kg 20 lb	9 kg 20 lb
Lampadine N. Tipo W max. Bulbs N. Type W max.	1 E27 100 1 E26 100	1 E27 100 1 E26 100
Dimmerabile Dimmable	D	D
Lampadine incluse Bulbs included		
Certificazioni Certification Marks		

Colori disponibili Available colours



BB
Bianco
White

Finiture Finishings



CN
Cromo Nero
Dark Chrome



OZ
Bronzo Miele
Honey Bronze



CEILING

Si integrano e si combinano con l'architettura degli ambienti creando un dialogo tra superfici e luci, tra spazio bidimensionale e tridimensionale. Puntuali, oppure modulari, realizzano atmosfere inebrianti e sofisticate.

They interact and combine with the architecture of spaces, creating a dialogue between surfaces and lights, in two and three dimensions. Used individually or in compositions, they produce inebriating and sophisticated atmospheres.

ALUMINA

Alessandro Piva

Con un lato di 85 centimetri, è una plafoniera davvero importante, ma comunque leggera nell'aspetto. È composta da cinque elementi quadrangolari decorati a bolle sommerse e realizzati completamente a mano. A completare la composizione, ai cinque elementi in cristallo veneziano si aggiungono quattro griglie decorative in metallo a trama diversa. Grazie alla sua geometria, Alumina può essere utilizzata in molteplici unità affiancate, a formare una parete luminosa.

With a side measuring 33 1/2", it is a really considerable ceiling lamp, but still giving an appearance of lightness. It is made up by five quadrangular elements decorated with submerged bubbles all completely handcrafted. To complete the composition, four decorative and differently finished metal grilles are added to the five Venetian crystal elements. Thanks to its geometry, Alumina can be used in multiple modules side by side, to create a luminous wall.

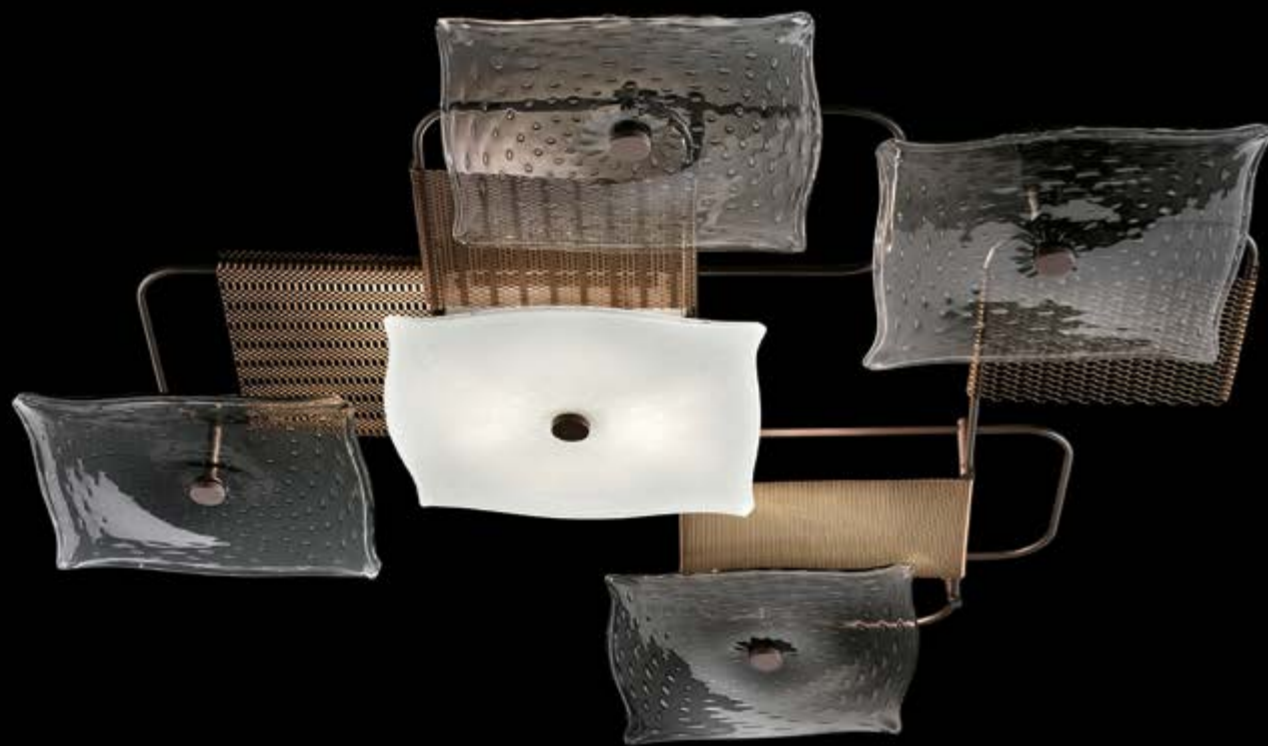

Modelli e misure Models and sizes

Alumina
7285

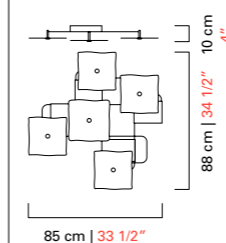

Peso
Weight

8 kg
17 1/2 lb

Lampadine
Bulbs

N.	Tipo	W max.
N.	Type	W max.
4	G9	4
4		4

Dimmerabile
Dimmable

D

Lampadine incluse
Bulbs included

G9 Led

Certificazioni
Certification Marks



Colori disponibili Available colours



CC
Cristallo
Crystal



BW
Brown
Brown

Finiture Finishings



ZO
Bronzo Satinato
Satinized Bronze

ANVERSA

Questa lampada a soffitto prende a prestito il rostrato, elemento caratteristico di due collezioni di enorme successo, Amsterdam e Rotterdam, e lo abbina al diffusore bianco ed al cristallo veneziano in colori tenui dell'ogiva decorativa.

This ceiling lamp borrows the characteristic "rostrato" element from two highly successful collections, Amsterdam and Rotterdam, combining it with the white diffuser and the Venetian crystal in muted colors of the decorative nose cone.



Modelli e misure Models and sizes

	Anversa 5697	Anversa 5698
Peso Weight	4 kg 9 lb	7 kg 15 lb
Lampadine Bulbs	N. Tipo W max. 3 E14 60 E12 60	N. Tipo W max. 3 E14 60 E12 60
Dimmerabile Dimmable	D	D
Lampadine incluse Bulbs included		
Certificazioni Certification Marks		

Colori disponibili Available colours



CC
Cristallo
Crystal



IC
Grigio
Grey



EK
Sabbia
Sand



DK
Oliva
Olive



AK
Blu Cadetto
Cadet Blue



LQ
Bluastro
Bluastro



FK
Indaco
Indigo



CK
Pervinca
Periwinkle



VI
Viola
Violet



OO
Oro
Gold

Finiture Finishings







CL
Cromo Lucido
Polished Chrome

EXCELSIOR

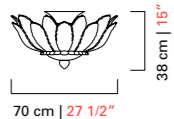
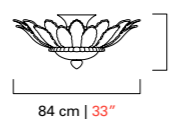
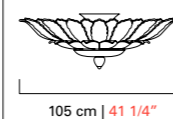
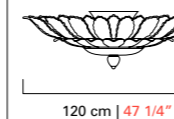

Oggetti che rimandano alla magnificenza dei grandi progetti di alberghi e navi da crociera realizzati da Barovier&Toso nella prima metà del '900. Plafoniere di grande eleganza, proposte in suggestive e particolari finiture.

Objects that recall the magnificence of the big hospitality and cruise projects that Barovier&Toso developed during the first half of the 20th century. Extremely elegant ceiling lamps proposed in a distinctive range of finishes.

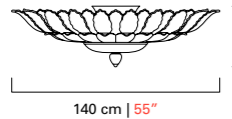

Modelli e misure <i>Models and sizes</i>	Excelsior 5363	Excelsior 5364	Excelsior 5426	Excelsior 5427
	 70 cm 27 1/2" 38 cm 15"	 84 cm 33" 35 cm 13 1/2"	 105 cm 41 1/4" 36 cm 14"	 120 cm 47 1/4" 38 cm 15"
Peso Weight	22 kg 48 lb	28 kg 62 lb	54 kg 119 lb	63 kg 139 lb
Lampadine N. Tipo W max. Bulbs N. Type W max.	6 E14 60 E12 60	6+3 E14 60+40 E12 60+40	8+3 E27+E14 60+40 E26+E12 60+40	10+4 E27+E14 60+40 E26+E12 60+40
Dimmerabile Dimmable	D	D	D	D
Lampadine incluse Bulbs included				
Certificazioni Certification Marks				

Colori disponibili
Available colours**CR**
Cristallo Rugiada
Crystal Rugiada**GR**
Champagne Rugiada
Champagne Rugiada**OR**
Oro Rugiada
*Gold Rugiada***Finiture**
Finishings**OG**
Oro Galvanizzato
Galvanized Gold

Modelli e misure <i>Models and sizes</i>	Excelsior 5428
	 140 cm 55" 40 cm 15 1/2"
Peso Weight	72 kg 158 lb
Lampadine N. Tipo W max. Bulbs N. Type W max.	15+3 E27+E14 60+40 E26+E12 60+40
Dimmerabile Dimmable	D
Lampadine incluse Bulbs included	
Certificazioni Certification Marks	

GRAND HOTEL

Una plafoniera di successo della nostra più classica produzione, dove l'elegante disegno floreale e la lavorazione realizzata con la tecnica della rugiada, permettono effetti decorativi di grande suggestione.

One of the most successful ceiling lamps from our classical collections, its elegant floral design and the "rugiada" technique enable attractive and impressive decorative effects.

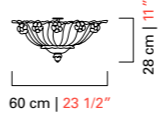
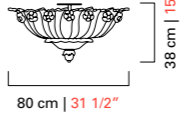

Modelli e misure Models and sizes

	Grand Hotel 5116/60	Grand Hotel 5116/80
	 <p>60 cm 23 1/2"</p> <p>28 cm 11"</p>	 <p>80 cm 31 1/2"</p> <p>38 cm 15"</p>
Peso Weight	15 kg 33 lb	26 kg 57 lb
Lampadine Bulbs	N. Tipo W max. 5 E14 60 E12 60	N. Tipo W max. 8 E27 100 E26 60
Dimmerabile Dimmable	D	D
Lampadine incluse Bulbs included		
Certificazioni Certification Marks	ERAC	ERAC

Colori disponibili Available colours



CR
Cristallo Rugiada
Crystal Rugiada



OR
Oro Rugiada
Gold Rugiada

Finiture Finishings



OL
Ottone Lucido
Polished Brass

MARRAKECH

Il punto di forza di Marrakech, oltre alla versatilità di essere indifferentemente lampada da soffitto o da parete, è la sua illimitata componibilità: la forma a esagono regolare consente di affiancare senza fine le mattonelle in vetro che caratterizzano la collezione, ciascuna con una peculiare lavorazione della superficie (fino a tre diverse). L'effetto "rugiada" applicato sul retro degli elementi, una tecnica brevettata da Barovier&Toso nel XX secolo, diffonde la luce fornita da strisce led a bassa tensione incastonate nelle strutture metalliche di sostegno.

The greatest strength of Marrakech, apart from its ability to be used either as a ceiling or wall lamp, is its limitless configuration potential: the regular hexagonal tiles allow endless additions of the glass elements which distinguish the collection, with their different surface designs (up to three versions). The "rugiada" effect applied to the back of each element, a technique patented by Barovier&Toso in the 20th century, diffuses the light supplied by the low voltage led strips housed in the metallic support structure.

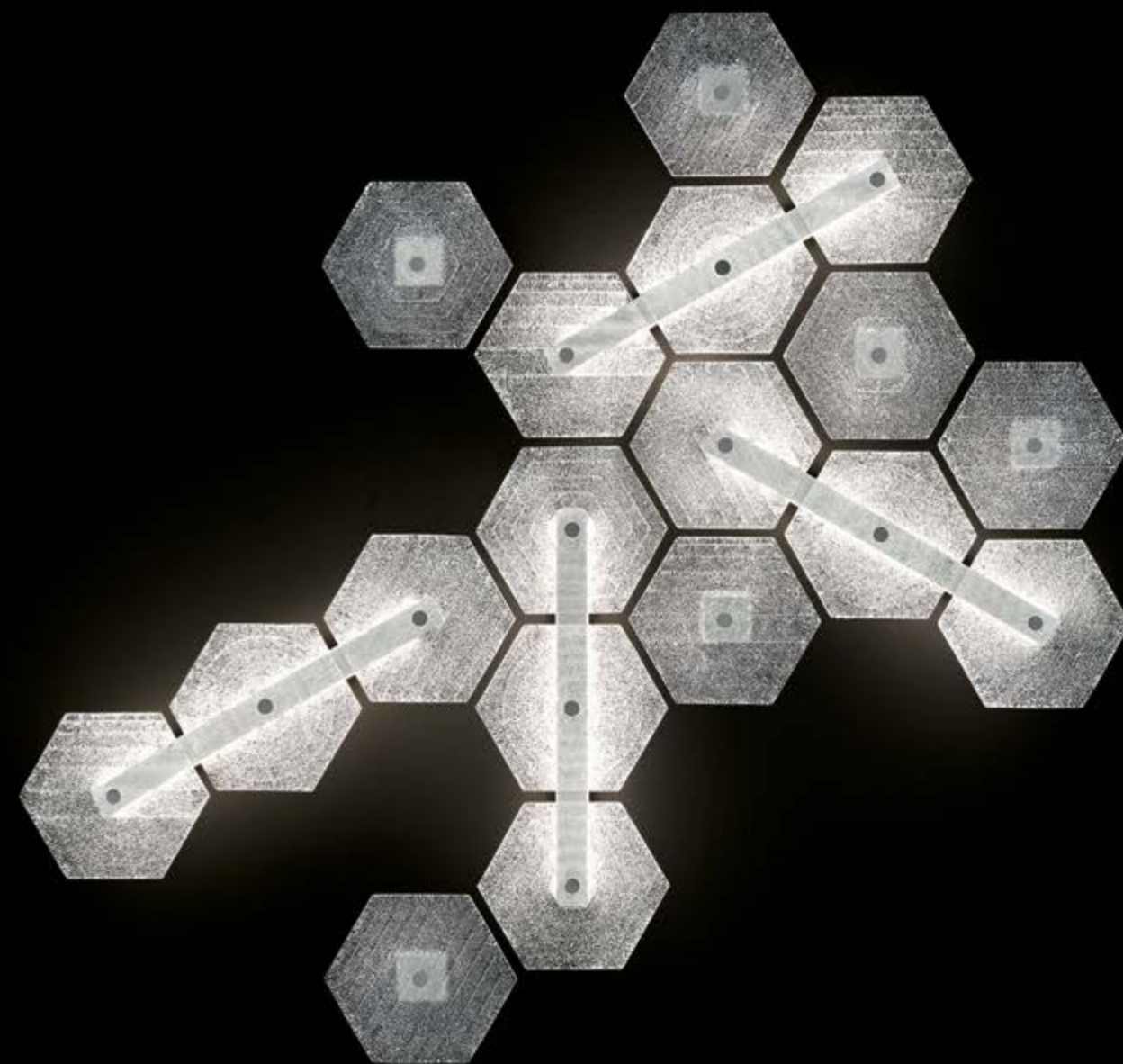
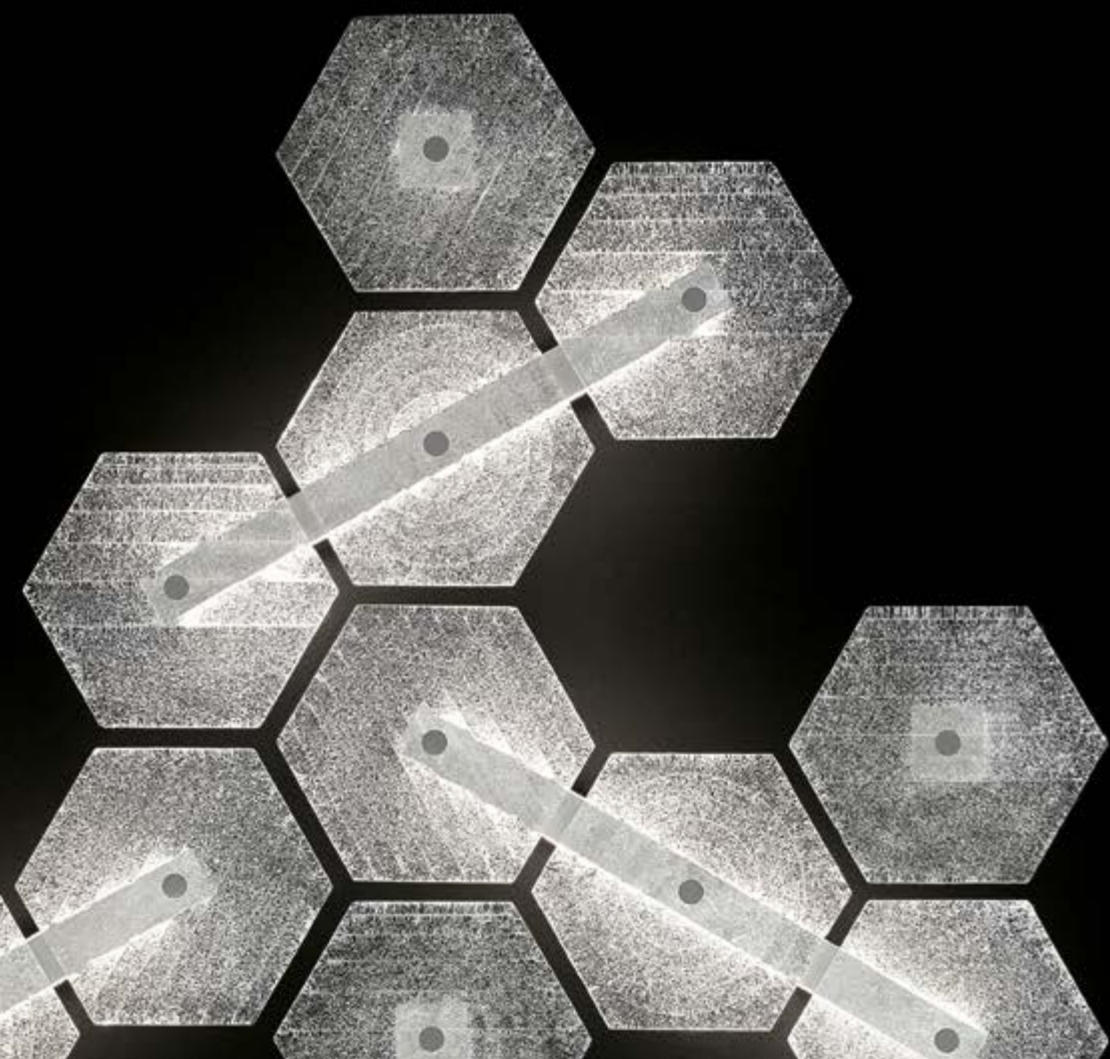

Modelli e misure Models and sizes	Marrakech 7367/A	Marrakech 7368/A	Marrakech 7369/A	Marrakech 7370/A
Peso Weight	8 kg 18 lb	12 kg 26 lb	17 kg 37 lb	21 kg 46 lb
Lampadine N. Tipo W max. Bulbs N. Type W max.	1 Strip Led 20 20	1 Strip Led 20 20	1 Strip Led 20 20	2 Strip Led 20 20
Dimmerabile Dimmable				
Lampadine incluse Bulbs included	Strip Led	Strip Led	Strip Led	Strip Led
Certificazioni Certification Marks				

Colori disponibili
Available coloursCC
Cristallo
Crystal**Finiture**
FinishingsVG
Verniciato Bianco
Painted White

Modelli e misure Models and sizes	Marrakech 7371/A	Marrakech 7372/A
Peso Weight	28 kg 61 lb	40 kg 88 lb
Lampadine N. Tipo W max. Bulbs N. Type W max.	3 Strip Led 20 20	4 Strip Led 20 20
Dimmerabile Dimmable		
Lampadine incluse Bulbs included	Strip Led	Strip Led
Certificazioni Certification Marks		

NEW FELCI

Per immergersi in una suggestiva atmosfera dallo stile déco, ammiccando al gusto glamour degli anni '20 e '30. Il fascino di una cascata di luce composta da brillanti e voluttuose foglie in cristallo veneziano delicatamente aricchiate alle estremità.

For a plunge into an evocative Deco mood that takes its cue from the glamour of the 1920s and 1930s. The charm of a cascade of light composed of sparkling and voluptuous leaves of Venetian crystal, delicately curled at the extremities.



Modelli e misure Models and sizes

	New Felci 7244	New Felci 7245
Peso Weight	46 kg 101 lb	72 kg 158 lb
Lampadine Bulbs	N. Tipo W max. 8+1 E14+E14 60+40 N. Type W max. E12+E12 5+5	12+1 E14+E14 60+40 E12+E12 60+40
Dimmerabile Dimmable	D	D
Lampadine incluse Bulbs included		
Certificazioni Certification Marks		

Colori disponibili Available colours



CC
Cristallo
Crystal

Finiture Finishings



CL
Cromo Lucido
Polished Chrome



OG
Oro Galvanizzato
Galvanized Gold







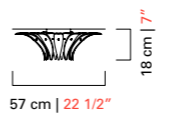
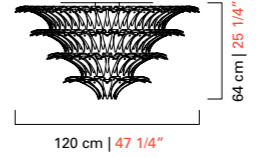
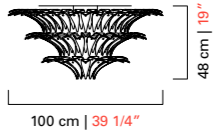
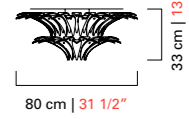

PALMETTE

Una collezione che si distingue per la preziosità delle lavorazioni, rigorosamente realizzate artigianalmente e frutto di una ricerca stilistica che attinge alla storia per darne una interpretazione in chiave contemporanea. Ventagli in foglie di cristallo, sovrapposti a formare due, tre e quattro livelli per una rilettura intrigante dello stile déco.

A collection that stands out for precious workmanship rigorously done by hand, result of stylistic research that draws on history, granting it a contemporary interpretation. Fans of crystal leaves, placed to form two, three and four levels, for an intriguing take on Art Deco.



Modelli e misure Models and sizes

	Palmette 7385/3	Palmette 7385/17	Palmette 7385/18	Palmette 7385/19
				
Peso Weight	10 kg 22 lb	105 kg 231 lb	55 kg 121 lb	27 kg 60 lb
Lampadine Bulbs	N. Tipo W max. 2 E14 60 E12 40	28 E27 60 E26 40	16 E27 60 E26 40	6 E27 60 E26 40
Dimmerabile Dimmable	D	D	D	D
Lampadine incluse Bulbs included				
Certificazioni Certification Marks	ERC  	ERC  	ERC  	ERC  

Colori disponibili Available colours



CC
Cristallo
Crystal

Finiture Finishings



CL
Cromo Lucido
Polished Chrome



OG
Oro Galvanizzato
Galvanized Gold

PIGALLE

Tradizione ed innovazione si fondono in questa collezione ispirata alla Belle Époque. Si caratterizza per eleganza e linee sinuose senza risultare eccessiva ed ostentata. Eloquente per raffinatezza e grazia alterna linee semplici, dettagli curvi e lavorazioni tradizionali.

Tradition and innovation blend in this collection inspired by the Belle Époque. It stands out for its elegant, sinuous lines, without ever seeming excessive or ostentatious. With its eloquent refinement and grace, it mixes simple lines, curved details and traditional workmanship.



Modelli e misure Models and sizes

	Pigalle 5688	Pigalle 5690
Peso Weight	7 kg 15 lb	4 kg 9 lb
Lampadine Bulbs	N. Tipo W max. 3 E14 60 E12 60	N. Tipo W max. 3 E14 60 E12 60
Dimmerabile Dimmable	D	D
Lampadine incluse Bulbs included		
Certificazioni Certification Marks		

Colori disponibili Available colours



CC
Cristallo
Crystal

Finiture Finishings



CL
Cromo Lucido
Polished Chrome



CN
Cromo Nero
Dark Chrome

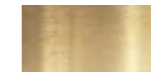

OJ
Oro Spazzolato
Brushed Gold





PIUME

Riprese dai disegni degli anni '20 e '30 del nostro archivio storico, queste plafoniere sono un omaggio allo stile Déco. Con le loro ricche piume evocano ambientazioni lussuose e ricercate. Adatte ad ambienti estremamente decorati come anche, per contrasto, ad interni più minimali.

Resumed from drawings of the 20ies and 30ies from our historical archive, these ceiling lamps pay a tribute to the Déco era. With their rich feathers they evoke luxurious and refined settings. Perfect for extremely decorated ambiances as well as, playing with contrasts, for more minimal interior design projects.

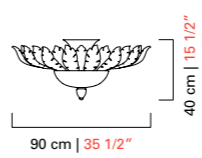
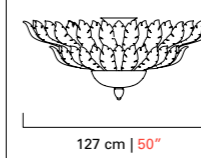
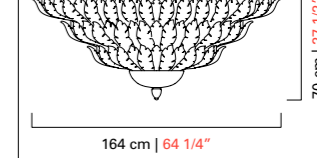

Modelli e misure Models and sizes

	Piume 5399	Piume 5400	Piume 5401
			
Peso Weight	33 kg 73 lb	80 kg 176 lb	140 kg 308 lb
Lampadine Bulbs	N. Tipo W max. 8+3 E27+E14 60+40 E26+E12 60+40	N. Tipo W max. 14+3 E27+E14 60+40 E26+E12 60+40	N. Tipo W max. 30+3 E27+E14 60+40 E26+E12 60+40
Dimmerabile Dimmable	D	D	D
Lampadine incluse Bulbs included			
Certificazioni Certification Marks			

Colori disponibili Available colours



OB
Oro Beige
Beige Gold

Finiture Finishings



OG
Oro Galvanizzato
Galvanized Gold

PLISSÉ

Una collezione di plafoniere direttamente ispirata dalla tradizione. Gli elementi in cristallo veneziano sono realizzati grazie a una tecnica brevettata da Barovier&Toso, che consente di ottenere un effetto striato regolare che alterna il colore pieno a quello trasparente.

A collection of ceiling lamps directly inspired by the tradition. A technique patented by Barovier&Toso that allows to obtain a regular striped effect alternating matt and transparent colours on the Venetian crystal elements.



Modelli e misure Models and sizes

	Plissé 6700	Plissé 6701
Peso Weight	23 kg 51 lb	28 kg 62 lb
Lampadine N. Tipo W max. Bulbs N. Type W max.	8 E14 60 E12 25	9 E27 60 E26 25
Dimmerabile Dimmable	D	D
Lampadine incluse Bulbs included		
Certificazioni Certification Marks		

Colori disponibili Available colours



BB
Bianco
White

Finiture Finishings



VG
Verniciato Bianco
Painted White

REX

Un grande fiore che fluttua nell'aria. Petali preziosi ed elaborati che grazie all'utilizzo della tecnica della "rugiada" sembrano dei merletti fatti a mano. Plafoniere spesso scelte all'inizio del '900 per grandi progetti di navi da crociera e alberghi di lusso sono ancora oggi dei pezzi unici capaci di donare un tocco retrò anche a progetti più contemporanei.

A large flower that floats in the air. Precious and elaborated petals that thanks to the "rugiada" technique seem handmade laces. These ceiling lamps were very common at the beginning of the 20th century in big cruises and luxury hotels projects but nowadays they are still unique pieces capable to give a retrò touch also to more contemporary projects.

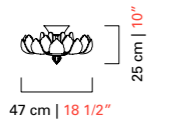
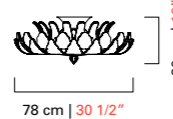
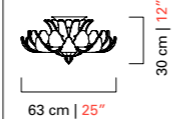
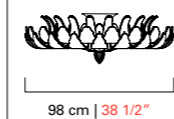

Modelli e misure <i>Models and sizes</i>	Rex 5387	Rex 5358	Rex 5357	Rex 5431
				
Peso Weight	10 kg 22 lb	29 kg 64 lb	18 kg 40 lb	54 kg 119 lb
Lampadine N. Tipo W max. Bulbs N. Type W max.	9 E14 60 E12 60	12 E14 60 E12 60	9+2 E14 60+40 E12 60+40	13 E14 60 E12 40
Dimmerabile Dimmable	D	D	D	D
Lampadine incluse Bulbs included				
Certificazioni Certification Marks				

Colori disponibili
Available colours



CR
Cristallo Rugiada
Crystal Rugiada



GR
Champagne Rugiada
Champagne Rugiada



OR
Oro Rugiada
Gold Rugiada

Finiture
Finishings

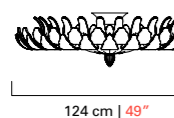

OF
Ottone Spazzolato Fine
Fine Brushed Brass

Modelli e misure <i>Models and sizes</i>	Rex 5432
	
Peso Weight	72 kg 158 lb
Lampadine N. Tipo W max. Bulbs N. Type W max.	17 E14 60 E12 60
Dimmerabile Dimmable	D
Lampadine incluse Bulbs included	
Certificazioni Certification Marks	



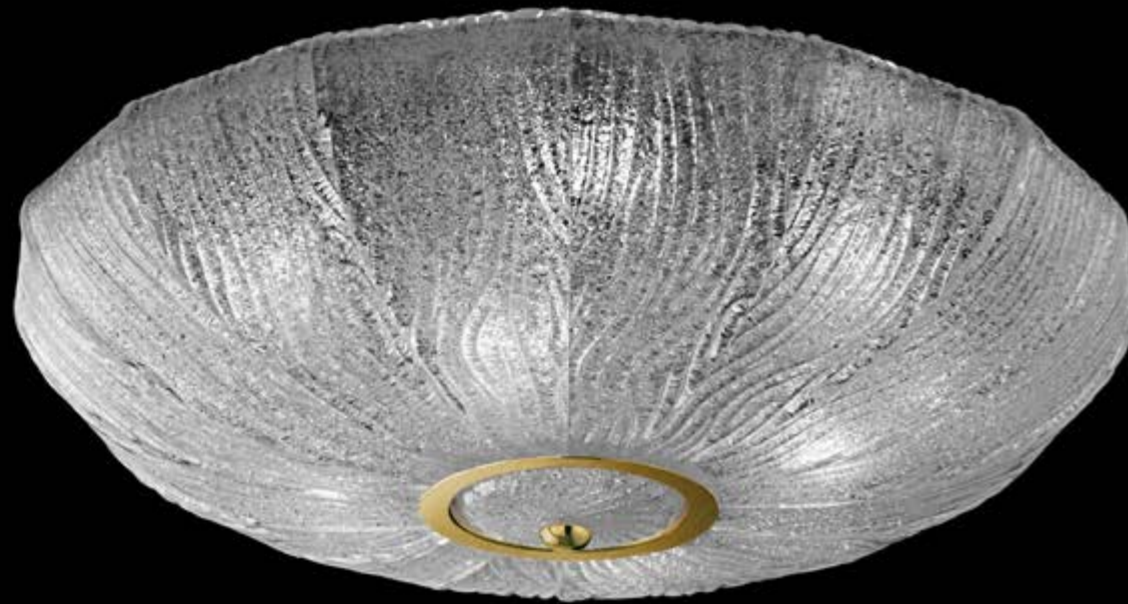

ROYAL

Collezione di plafoniere dal disegno essenziale e pulito. L'effetto scenografico è interamente demandato alla raffinata lavorazione muranese a "rugiada" che rende la superficie estremamente ricca e preziosa grazie anche alla tradizionale palette colori.

A collection of ceiling lamps with a very sharp and clean design. The scenic effect is totally left to the refined Muranese technique "rugiada" that makes the surface texture extremely rich and precious thanks also to the traditional colour palette.

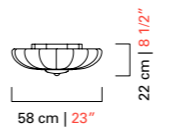
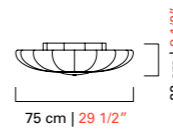
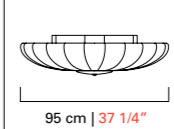
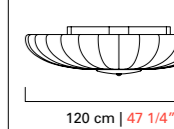

Modelli e misure Models and sizes

	Royal 5406	Royal 5407	Royal 5408	Royal 5409
				
Peso Weight	15 kg 33 lb	22 kg 48 lb	39 kg 86 lb	58 kg 128 lb
Lampadine Bulbs	N. Tipo W max. 7 E27 60 E26 60	8+5 E27+E14 60 E26+E12 60	16 E27 60 E26 60	19 E27 60 E26 60
Dimmerabile Dimmable	D	D	D	D
Lampadine incluse Bulbs included				
Certificazioni Certification Marks				

Colori disponibili Available colours



CR
Cristallo Rugiada
Crystal Rugiada

Finiture Finishings



OF
Ottone
Spazzolato Fine
Fine Brushed Brass



SPADE

Collezione di plafoniere ispirata ai fiori e alla natura che si contraddistingue per il suo delicato design a forma di corolla, realizzata con la tecnica della "rugiada" che dona un raffinato effetto ricamato. I petali si sovrappongono come a formare dei fiori schiusi, sospesi nell'aria.

A collection of ceiling lamps with an accent on flowers and nature, which stands out for its delicate design in the form of a corolla, made with the "rugiada" technique to create a refined embroidered look. Petals overlap to form the image of a blossoming flower, suspended in the air.

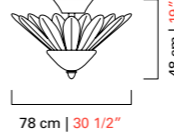
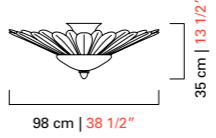

Modelli e misure Models and sizes

	Spade 6744	Spade 6745
		
Peso Weight	32 kg 70 lb	41 kg 90 lb
Lampadine Bulbs	N. Tipo W max. 8+2 E14 60+40 E12 60+40	N. Tipo W max. 8+3 E14 60+40 E12 60+40
Dimmerabile Dimmable	D	D
Lampadine incluse Bulbs included		
Certificazioni Certification Marks		

Colori disponibili Available colours



CR
Cristallo Rugiada
Crystal Rugiada

Finiture Finishings



CL
Cromo Lucido
Polished Chrome



OG
Oro Galvanizzato
Galvanized Gold



OF
Ottone
Spazzolato Fine
Fine Brushed Brass

TOPKAPI

Daniela Puppa

Topkapi è una famiglia di lampade a soffitto che si caratterizzano per il contrasto tra il grande diffusore dalle linee moderne in vetro bianco sabbato - che diffonde una luce morbida e soffusa - e i classici finalini in cristallo trasparente o dai colori vivaci, che brillano per effetto dell'irradiazione diretta.

Topkapi is a family of ceiling lamps characterized by the contrast between the modern lines of the diffuser in white sanded glass which sends out a soft, suffused light, and the classic end-elements in transparent or vividly coloured crystal that shine with the brightness of direct lighting.



Modelli e misure Models and sizes

	Topkapi 7093/45	Topkapi 7093/60	Topkapi 7094/45	Topkapi 7094/60
Peso Weight	8 kg 18 lb	10 kg 22 lb	7 kg 15 lb	9 kg 20 lb
Lampadine Bulbs	N. Tipo W max. 2 E14 60 E12 60	3 E14 60 E12 60	2 E14 60 E12 60	3 E14 60 E12 60
Dimmerabile Dimmable	D	D	D	D
Lampadine incluse Bulbs included				
Certificazioni Certification Marks				

Colori disponibili Available colours



CC
Cristallo
Crystal



IC
Grigio
Grey



EK
Sabbia
Sand



DK
Oliva
Olive



AK
Blu Cadetto
Cadet Blue



LQ
Bluastro
Bluastro



FK
Indaco
Indigo



CK
Pervinca
Periwinkle



VI
Viola
Violet



OO
Oro
Gold

Finiture Finishings





VG
Verniciato Bianco
Painted White

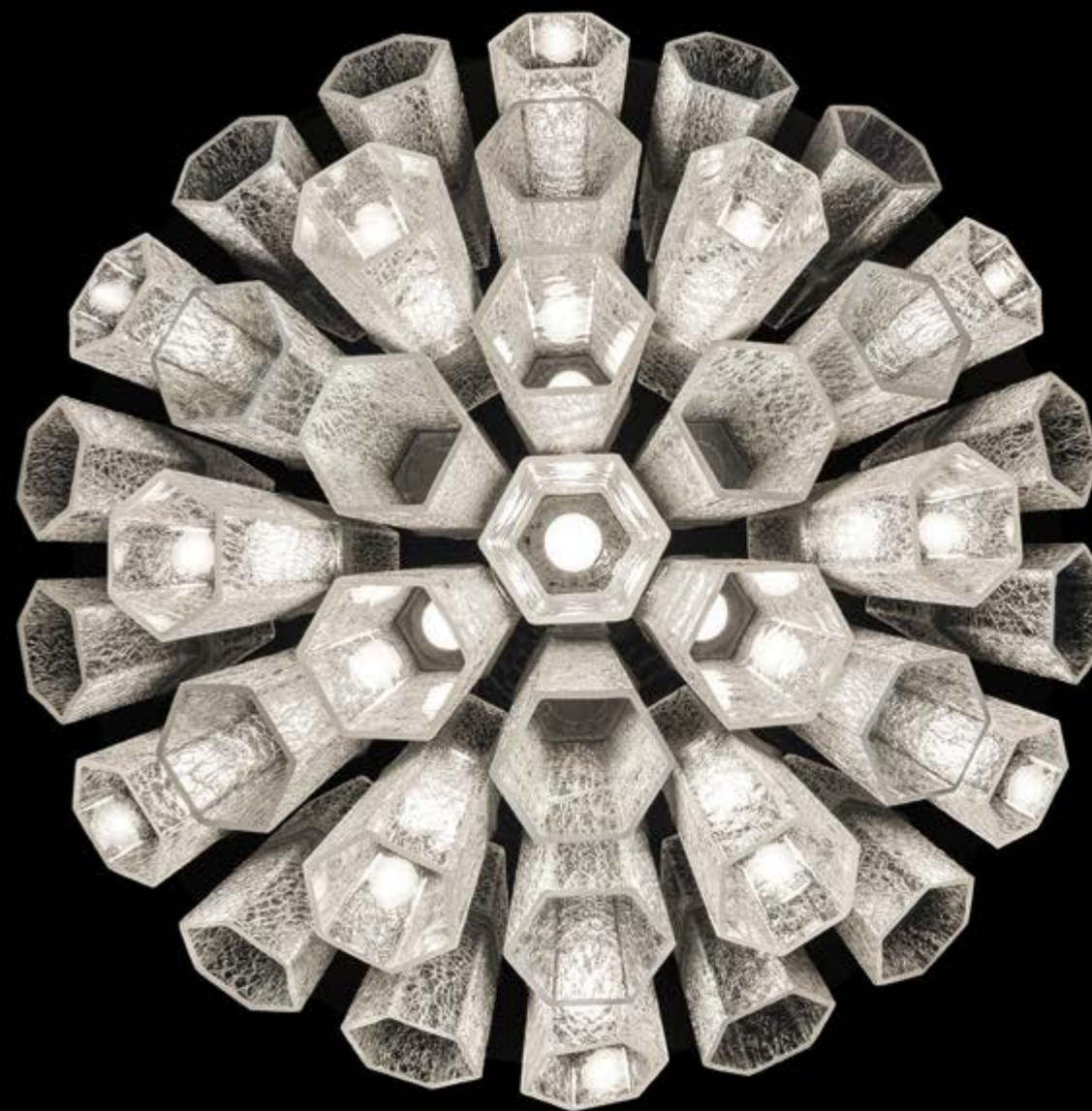

TRIM

Questa collezione attinge dall'archivio delle grandi installazioni realizzate da Barovier&Toso negli anni '60 e '70 attraverso la moltiplicazione e ripetizione di elementi modulari a canne o a poliedri, lisci o arricchiti dalle tradizionali lavorazioni muranesi. L'elemento esagonale realizzato con l'antica tecnica detta "ghiaccio" genera volumi sferici, per riflessione sul plafone specchiato, che perfettamente si integrano nell'architettura degli spazi diventandone quasi un'estensione. La posizione dei moduli può essere personalizzata al momento dell'installazione secondo il proprio estro: un ordine simmetrico e regolare oppure una forma disordinata.

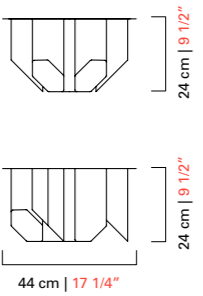
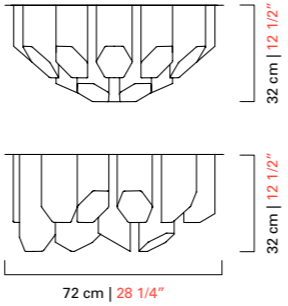
The collection builds on the archive of large installations made by Barovier&Toso in the 1960s and 1970s, multiplying and repeating modular parts, simple or polyhedral, smooth or enhanced by traditional Murano workmanship. The hexagonal tube made with the age-old "ice" technique generates spherical volumes, thanks to the reflection on the mirrored metal structure, that fit perfectly into the architecture of spaces, almost becoming its extension. According to your own creativity, the position of the modules can be customized during installation into a symmetrical and conventional order or into a messy shape.

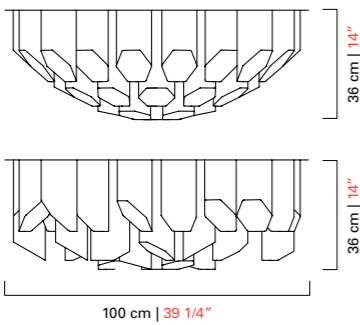
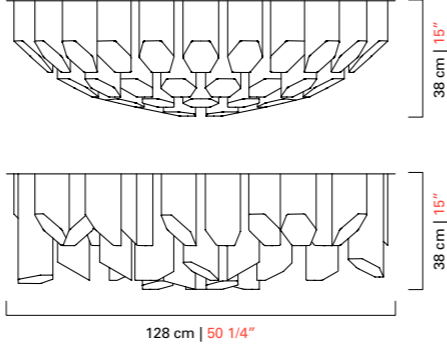

Modelli e misure Models and sizes		Trim 7317	Trim 7318
			
Peso Weight		18 kg 40 lb	45 kg 99 lb
Lampadine N. Tipo W max. Bulbs N. Type W max.		4 Led 12 8	10 Led 12 8
Dimmerabile Dimmable		D	D
Lampadine incluse Bulbs included		Led	Led
Certificazioni Cerification Marks			

Modelli e misure Models and sizes		Trim 7319	Trim 7320
			
Peso Weight		90 kg 198 lb	160 kg 352 lb
Lampadine N. Tipo W max. Bulbs N. Type W max.		16 Led 12 8	28 Led 12 8
Dimmerabile Dimmable		D	D
Lampadine incluse Bulbs included		Led	Led
Certificazioni Cerification Marks			

Colori disponibili
Available colours

CC
 Cristallo
 Crystal

Finiture
Finishings

CL
 Cromo Lucido
 Polished Chrome

CN
 Cromo Nero
 Dark Chrome

OF
 Ottone
 Spazzolato Fine
 Fine Brushed Brass

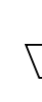

WALL

Punteggiano le pareti, come opere d'arte che impreziosiscono e vestono di personalità gli spazi da vivere e condividere. Dal gusto più classico a quello più semplice e moderno, ogni modello riesce ad enfatizzare la preziosità del Cristallo Veneziano e l'artigianalità delle sue lavorazioni.

They punctuate walls like works of art that enhance and bring personality to spaces for living and sharing. From the most classical taste to simple, modern styling, each model underscores the precious value of Venetian crystal, and the skill that goes into its making.

4604

Completano la collezione di lampadari in stile veneziano due lampade da parete in dimensioni diverse, riprendendo gli stessi elementi caratteristici quali foglie, fiori e pinnacoli.

The collection of Venetian style chandeliers is completed by two wall lamps in different sizes, taking up the same characteristic elements such as leaves, flowers and pinnacles.



Modelli e misure Models and sizes

	4604 4604/02	4604 4604/05
Peso Weight	7 kg 15 lb	13 kg 29 lb
Lampadine Bulbs	N. Tipo W max. 2 E14 60 E12 60	N. Tipo W max. 5 E14 60 E12 60
Dimmerabile Dimmable	D	D
Lampadine incluse Bulbs included		
Certificazioni Certification Marks		

Colori disponibili Available colours



CC
Cristallo
Crystal



DO
Cristallo
Decoro Oro
Crystal Gold
Decoration



LQ
Cristallo
Decoro Bluastro
Crystal Bluastro
Decoration



***OO**
Oro
Gold
*Solo OG
Only OG



PC
Policromo
Polychrome

Finiture Finishings



CL
Cromo Lucido
Polished Chrome



***OG**
Oro Galvanizzato
Galvanized Gold
*Solo OO
Only OO

4607

Questa applique in cristallo veneziano è un eccellente esempio della raffinata lavorazione artigianale. Una moltitudine di decorazioni, dettagli preziosissimi, a completamento dei meravigliosi e fastosi lampadari della collezione.

This Venetian crystal wall lamp is an excellent example of refined craftsmanship. A multitude of decorations, precious details that complete the wonderful and sumptuous collection of chandeliers.



Modelli e misure Models and sizes

4607

4607/02

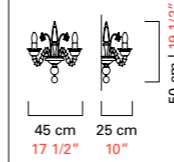

Peso

7 kg

Weight

15 lb

Lampadine

N.	Tipo	W max.
2	E14	60

Bulbs

N.	Type	W max.
	E12	60

Dimmerabile Dimmable

D

Lampadine incluse Bulbs included

Certificazioni Certification Marks



Colori disponibili Available colours



CC

Cristallo
Crystal

DO

Cristallo
Decoro Oro
Crystal Gold
Decoration

LQ

Cristallo
Decoro Bluastro
Crystal Bluastro
Decoration

*OO

Oro
Gold
*Solo OO
Only OO

PC

Polichromo
Polychrome

Finiture Finishings



CL

Cromo Lucido
Polished Chrome

*OG

Oro Galvanizzato
Galvanized Gold
*Solo OO
Only OO

ADONIS

Marcel Wanders Studio

Adonis è una applique creata da Marcel Wanders, ispirata alla tradizione floreale olandese e contaminata da quella vetraria muranese che, da sempre, usa i fiori come elemento distintivo. Leggiadre farfalle e boccioli di tulipano adornano questa lampada a muro.

Adonis is a wall sconce created by Marcel Wanders, inspired by the Dutch floral tradition and fused with Murano glassmaking, which has always featured flowers as a distinctive feature. Graceful butterflies and tulip buds adorn this wall lamp.



Modelli e misure Models and sizes

Adonis
7360/01

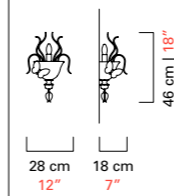

Peso Weight	7 kg 15 lb
Lampadine Bulbs	N. Tipo W max. 1 E14 60 N. Type W max. E12 60
Dimmerabile Dimmable	D
Lampadine incluse Bulbs included	
Certificazioni Certification Marks	UL ENEC UL US

Colori disponibili Available colours



CC
Cristallo
Crystal



AU
Cristallo / Verde
Antalia / Cedro
Liquido
Crystal / Antalia
Green / Liquid
Citron



LA
Cristallo / Bluastro /
Acquamare
Crystal / Bluastro /
Aquamarine



LN
Cristallo / Caramello
/ Cognac
Crystal / Caramel /
Cognac



EU
Bianco / Rubino
/ Rosè
White / Ruby / Light
Pink

Finiture Finishings



CL
Cromo Lucido
Polished Chrome



***OG**
Oro Galvanizzato
Galvanized Gold
*Solo CC e LN
Only CC and LN

AGADIR

Dall'archivio storico pluricentenario di Barovier&Toso una lampada a muro in cristallo veneziano in grado di creare atmosfere incredibilmente rarefatte grazie alla luce soffusa che solo l'elaborata decorazione permette di avere. Minuziose lavorazioni di sapienti mani trasformano il vetro in luce.

From the centuries-old historical archive of Barovier&Toso, a wall sconce in Venetian crystal capable of creating incredibly rarefied atmospheres thanks to the soft radiance that can only be produced by elaborate decoration. Painstaking handwork transforms glass into light.



Modelli e misure Models and sizes

Agadir
5384/02

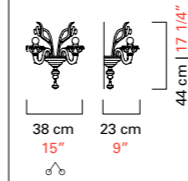

Peso

Weight

3 kg
7 lb

Lampadine

Bulbs

N.	Tipo	W max.
2	E14	60
	E12	60

Dimmerabile

Dimmable

D

Lampadine incluse

Bulbs included

Certificazioni

Certification Marks



Colori disponibili

Available colours



CC

Cristallo
Crystal



DO

Cristallo
Decoro Oro
Crystal Gold
Decoration



***OO**

Oro
Gold
*Solo OG
Only OG



LQ

Cristallo
Decoro Bluastro
Crystal Bluastro
Decoration

Finiture

Finishings



CL

Cromo Lucido
Polished Chrome



***OG**

Oro Galvanizzato
Galvanized Gold
*Solo OO
Only OO

ALEXANDRIA

Delicata, moderna, dalle linee pulite, la lampada da parete di questa collezione ha due luci ed i paralumi in tessuto plissettato.

Delicate, modern, with clean lines, the wall lamp of this collection has two lights and pleated fabric shades.



Modelli e misure Models and sizes

Alexandria
5597/02

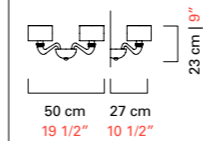

Peso Weight

4 kg
9 lb

Lampadine Bulbs

N.	Tipo	W max.
2	E14	60
	E12	60

Dimmerabile Dimmable

D

Lampadine incluse Bulbs included

Certificazioni Certification Marks



Colori disponibili Available colours



CC
Cristallo
Crystal



IC
Grigio
Grey



EK
Sabbia
Sand



DK
Oliva
Olive



AK
Blu Cadetto
Cadet Blue



LQ
Bluastro
Bluastro



FK
Indaco
Indigo



CK
Pervinca
Periwinkle



VI
Viola
Violet



***OO**
Oro
Gold
*Solo OO
Only OO

Finiture Finishings



CN
Cromo Nero
Dark Chrome



***OG**
Oro Galvanizzato
Galvanized Gold
*Solo OO
Only OO

Paralumi Shades

Nastro Pongè
Pongee Ribbon



BB
Bianco
White



NN
Nero
Black

ALUMINA

Alessandro Piva

Quando si parla di lampade da parete, si pensa sempre a elementi di dimensioni contenute, ma non è decisamente il caso di Alumina: con un lato di 85 centimetri, è una lampada davvero importante, ma comunque leggera nell'aspetto. È composta da cinque elementi quadrangolari decorati a bolle sommerse e realizzati completamente a mano. A completare la composizione, ai cinque elementi in cristallo veneziano si aggiungono quattro griglie decorative in metallo a trama diversa. Grazie alla sua geometria, Alumina può essere utilizzata in molteplici unità affiancate, a formare una parete luminosa.

When one speaks of a wall light, we always think of something reasonable small, but this is definitively not the case with Alumina: with a side measuring 33 1/2", it is a really considerable lamp, but still giving an appearance of lightness. It is made up by five quadrangular elements decorated with submerged bubbles all completely handcrafted. To complete the composition, four decorative and differently finished metal grilles are added to the five Venetian crystal elements. Thanks to its geometry, Alumina can be used in multiple modules side by side, to create a luminous wall.

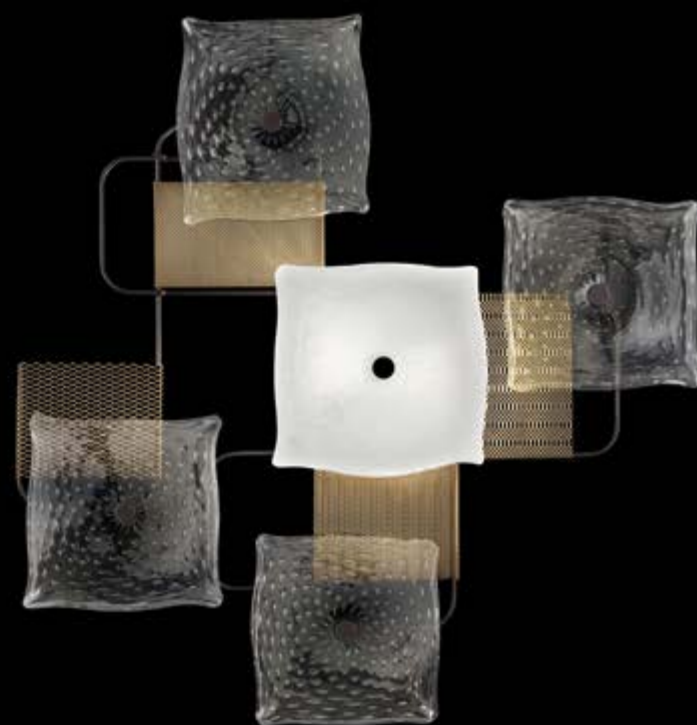

Modelli e misure Models and sizes

Alumina
7284

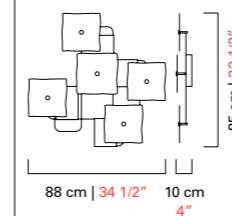

Peso

Weight

8 kg
17 1/2 lb

Lampadine

Bulbs

N.	Tipo	W max.
4	G9	4
		4

Dimmerabile

Dimmable

D

Lampadine incluse

Bulbs included

G9 Led

Certificazioni

Certification Marks



Colori disponibili

Available colours



CC
Cristallo
Crystal



BW
Brown
Brown

Finiture

Finishings



ZO
Bronzo Satinato
Satinized Bronze

AMSTERDAM

Applique che si caratterizza per il rostrato di cristallo, come il lampadario omonimo di cui è naturale complemento. Eleganza pragmatica, impreziosita da un tocco unico della tradizione vetraria di Venezia.

Wall sconce that is characterized by the crystal "rostrato," like the homonymous chandelier of which it is natural complement. Pragmatic elegance enriched by the unique touch of the Venetian glass-blowing tradition.

Domo Amsterdam design Franco Raggi

Il tradizionale fondino dove si inseriscono i bracci è sostituito da una struttura metallica dal disegno lineare.

A metal structure with a minimal design takes the place of the traditional glass chassis from where the arms depart.



Amsterdam 5562/02

Domo Amsterdam 7114/02

Modelli e misure Models and sizes

	Amsterdam 5562/02	Domo Amsterdam 7114/01	Domo Amsterdam 7114/02
Peso Weight	4 kg 9 lb	2,5 kg 6 lb	4 kg 9 lb
Lampadine Bulbs	N. Tipo W max. 2 E14 60	N. Tipo W max. 1 E14 60	N. Tipo W max. 2 E14 60
Dimmerabile Dimmable	D	D	D
Lampadine incluse Bulbs included			
Certificazioni Certification Marks			

Colori disponibili Available colours

*Per Amsterdam la finitura abbinata al colore OO è sempre OG. Per Domo Amsterdam la finitura abbinata al colore OO può essere CL, CN o OF.
For Amsterdam the finishing matching colour OO is always OG.
For Domo Amsterdam the finishings matching colour OO can be CL, CN or OF.



CC
Cristallo
Crystal



IC
Grigio
Grey



EK
Sabbia
Sand



DK
Oliva
Olive



AK
Blu Cadetto
Cadet Blue



LQ
Bluastro
Bluastro



FK
Indaco
Indigo



CK
Pervinca
Periwinkle



VI
Viola
Violet



***OO**
Oro
Gold

Finiture Finishings



CL
Cromo Lucido
Polished Chrome



***OG**
Oro Galvanizzato
Galvanized Gold
*Solo OO Amsterdam
Only OO Amsterdam



***CN**
Cromo Nero
Dark Chrome
*Solo Domo Amsterdam
Only Domo Amsterdam



***OF**
Ottone
Spazzolato Fine
Fine Brushed Brass
*Solo Domo Amsterdam
Only Domo Amsterdam

Paralumi Shades

Esterno: Cotone
External: Cotton

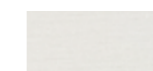
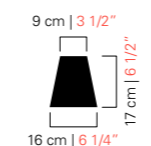

BB
Bianco
White



NN
Nero
Black



NO
Nero Interno Oro
Black Inner Gold

ANGEL

AI Design

Un ventaglio di piume che sembra fluttuare nello spazio come un'ala vaporosa che si dispiega leggera.

A feather fan that, seems to float in space like a vaporous wing that lightly unfolds itself.



Modelli e misure Models and sizes

Angel
7247

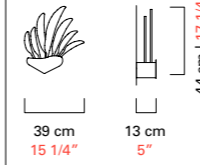

Peso
Weight

7 kg
15 lb

Lampadine N. Tipo W max.
Bulbs N. Type W max.

7	Led	1
		1

Dimmerabile
Dimmable

Lampadine incluse
Bulbs included

Led

Certificazioni
Certification Marks

ERAC

Colori disponibili
Available colours



CC
Cristallo
Crystal

Finiture
Finishings



VM
Verniciato Mirra
Painted Myrrh

ANVERSA

Questa applique prende a prestito il rostrato, elemento caratteristico di due collezioni di enorme successo, Amsterdam e Rotterdam, e lo abbina al diffusore bianco ed al cristallo veneziano in colori tenui dell'ogiva decorativa.

This wall sconce borrows the characteristic "rostrato" element from two highly successful collections, Amsterdam and Rotterdam, combining it with the white diffuser and the Venetian crystal in muted colors of the decorative nose cone.



Modelli e misure Models and sizes

Anversa
5699

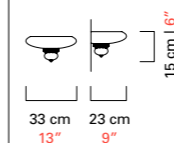

Peso

Weight

4 kg
20 lb

Lampadine

Bulbs

N.	Tipo	W max.
3	G9	25

Dimmerabile

Dimmable

D

Lampadine incluse

Bulbs included

G9 Led

Certificazioni

Certification Marks



Colori disponibili

Available colours



CC
Cristallo
Crystal



IC
Grigio
Grey



EK
Sabbia
Sand



DK
Oliva
Olive



AK
Blu Cadetto
Cadet Blue



LQ
Bluastro
Bluastro



FK
Indaco
Indigo

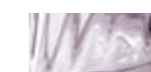

CK
Pervinca
Periwinkle



VI
Viola
Violet



OO
Oro
Gold

Finiture

Finishings



CL
Cromo Lucido
Polished Chrome

BABYLON

L'applique a due luci completa la collezione Babylon. Linee pulite e paralumi plissettati in tessuto, consentono di inserire questo prodotto in ogni ambientazione.

The two lights wall lamp completes the Babylon chandelier collection. Clean lines and pleated fabric lampshades allow to insert this product in any interior design project.



Modelli e misure Models and sizes

Babylon
5599/02

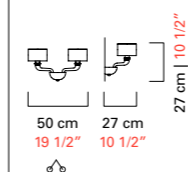

Peso Weight	4 kg 9 lb
Lampadine Bulbs	N. Tipo W max. 2 E14 60 N. Type W max. 2 E12 60
Dimmerabile Dimmable	D
Lampadine incluse Bulbs included	
Certificazioni Certification Marks	

Colori disponibili Available colours



CC
Cristallo
Crystal



IC
Grigio
Grey



EK
Sabbia
Sand



DK
Oliva
Olive



AK
Blu Cadetto
Cadet Blue



LQ
Bluastro
Bluastro



FK
Indaco
Indigo



CK
Pervinca
Periwinkle



VI
Viola
Violet



***OO**
Oro
Gold
*Solo OG
Only OG

Finiture Finishings



CN
Cromo Nero
Dark Chrome



***OG**
Oro Galvanizzato
Galvanized Gold
*Solo OO
Only OO

Paralumi Shades

Nastro Pongè
Pongee Ribbon

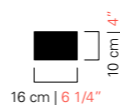

BB
Bianco
White



NN
Nero
Black

BAIKAL

Un'applique a due luci di ispirazione barocca. Ricca di dettagli preziosi come pendagli, pastorali e coppette che conferiscono maestosità e regalità rendendo l'oggetto assoluto protagonista dello spazio.

A two light wall sconce with a Baroque accent. Rich in precious details like pendants, pastorals and bobeches that add regal majesty, making the object the absolute protagonist of the space.



Modelli e misure Models and sizes

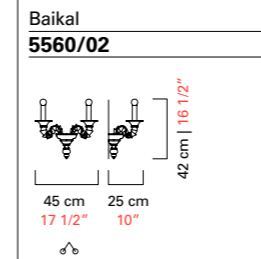

Peso Weight	5 kg 11 lb
Lampadine Bulbs	N. Tipo W max. 2 E14 60 N. Type W max. E12 60
Dimmerabile Dimmable	D
Lampadine incluse Bulbs included	
Certificazioni Certification Marks	

Colori disponibili Available colours



CC
Cristallo
Crystal



BB
Bianco
White



IC
Grigio
Grey



EK
Sabbia
Sand



DK
Oliva
Olive



LQ
Bluastro
Bluastro



FK
Indaco
Indigo



CK
Pervinca
Periwinkle



***OO**
Oro
Gold
*Solo OO
Only OO



NN
Nero
Black

Finiture Finishings



CL
Cromo Lucido
Polished Chrome



***OG**
Oro Galvanizzato
Galvanized Gold
*Solo OO
Only OO

BISSA BOBA

Angelo Barovier

In questa collezione l'applicque è a 3 luci. I bracci sembrano serpenti incantati che si ergono e allontanano sinuosamente dal centro.

In this collection the wall lamp has three lights. Its arms look like an enchanted snake, rising and sinuously moving away from the center.



Modelli e misure Models and sizes

Bissa Boba
6753/03

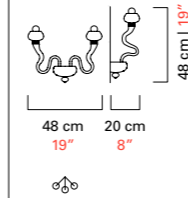

Peso Weight

3 kg
7 lb

Lampadine Bulbs

N.	Tipo	W max.
3	E14	60
	E12	60

Dimmerabile Dimmable

D

Lampadine incluse Bulbs included

Certificazioni Certification Marks



Colori disponibili Available colours



CC
Cristallo
Crystal



IC
Grigio
Grey



EK
Sabbia
Sand



DK
Oliva
Olive



AK
Blu Cadetto
Cadet Blue



LQ
Bluastro
Bluastro



FK
Indaco
Indigo

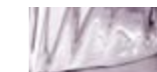

CK
Pervinca
Periwinkle



VI
Viola
Violet



***OO**
Oro
Gold
*Solo OG
Only OG

Finiture Finishings



CL
Cromo Lucido
Polished Chrome



***OG**
Oro Galvanizzato
Galvanized Gold
*Solo OO
Only OO

DEGAS

Elegante ed armonica questa slanciata lampada da muro a due luci affonda le radici nello storico archivio Barovier&Toso e prende il nome da uno dei più noti impressionisti francesi.

Elegant and harmonic, this slender two-lights wall lamp, has its roots in the historical Barovier&Toso archive and it is named after one of the most famous French impressionists.



Modelli e misure Models and sizes

Degas

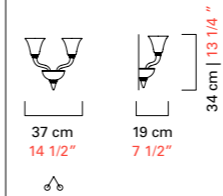
5554/02**Peso**

4 kg

Weight

9 lb

Lampadine

N. Tipo W max.

2

E14

60

Bulbs

N. Type W max.

2

E12

60

Dimmerabile

D

Dimmable**Lampadine incluse****Bulbs included****Certificazioni****Certification Marks**

Colori disponibili

Available colours**CC**Cristallo
Crystal**IC**Grigio
Grey**EK**Sabbia
Sand**DK**Oliva
Olive**AK**Blu Cadetto
Cadet Blue**LQ**Bluastro
Bluastro**FK**Indaco
Indigo**CK**Perivinca
Periwinkle**VI**Viola
Violet***OO**Oro
Gold
*Solo OG
Only OG

Finiture

Finishings**CL**Cromo Lucido
Polished Chrome***OG**Oro Galvanizzato
Galvanized Gold
*Solo OO
Only OO

DHAMAR

Questa applique è caratterizzata da pinnacoli in colore "affogato" nel cristallo e da particolari pendagli con sfere sfaccettate che ne fanno un elemento decorativo importante.

This wall sconce is characterized by colour "sunk" into crystal pinnacles and by pendants with a very unusual shape complemented by the multifaceted spheres, which conjure a compelling decorative effect.



Modelli e misure Models and sizes

Dhamar
5596/02

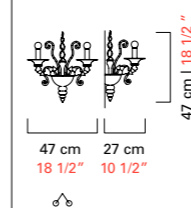

Peso Weight	7 kg 15 lb
Lampadine Bulbs	N. Tipo W max. 2 E14 60 N. Type W max. E12 60
Dimmerabile Dimmable	D
Lampadine incluse Bulbs included	
Certificazioni Certification Marks	

Colori disponibili Available colours



CC
Cristallo
Crystal



BB
Bianco
White



IC
Grigio
Grey



EK
Sabbia
Sand



DK
Oliva
Olive



LQ
Bluastro
Bluastro



FK
Indaco
Indigo



CK
Pervinca
Periwinkle



***OO**
Oro
Gold
*Solo OG
Only OG



NN
Nero
Black

Finiture Finishings



CL
Cromo Lucido
Polished Chrome



***OG**
Oro Galvanizzato
Galvanized Gold
*Solo OO
Only OO

EXCELSIOR

Oggetti che rimandano alla magnificenza dei grandi progetti di alberghi e navi da crociera realizzati da Barovier&Toso nella prima metà del '900. Lampade a muro di grande eleganza, proposte in suggestive e particolari finiture.

Objects that recall the magnificence of the big hospitality and cruise projects that Barovier&Toso developed during the first half of the 20th century. Extremely elegant wall sconces proposed in a distinctive range of finishes.



Modelli e misure Models and sizes

	Excelsior 5361	Excelsior 5362
	<p>21 cm 16 cm 39 cm 8 1/4" 6 1/4" 15 1/4"</p>	<p>38 cm 18 cm 40 cm 15" 7" 15 1/2"</p>
Peso Weight	6 kg 13 lb	8 kg 18 lb
Lampadine N. Tipo W max. Bulbs N. Type W max.	1 E27 60 E26 60	2 E27 60 E26 60
Dimmerabile Dimmable	D	D
Lampadine incluse Bulbs included		
Certificazioni Certification Marks		

Colori disponibili Available colours



CR
Cristallo Rugiada
Crystal Rugiada



GR
Champagne Rugiada
Champagne Rugiada



OR
Oro Rugiada
Gold Rugiada

Finiture Finishings



OG
Oro Galvanizzato
Galvanized Gold

FAUVE

Elementi caratterizzanti di questa collezione sono le foglie sottili ed allungate sapientemente lavorate dai maestri vetrai nelle nostre fornaci. Oggetti dal design pulito che si inseriscono facilmente nei contesti più variegati riuscendo ad impreziosire un angolo o una stanza.

The characteristic features of this collection are the thin extending leaves created by master craftsmen in our furnaces. Objects with a clean design, to easily insert in a wide range of contexts, enhancing a corner or an entire room.

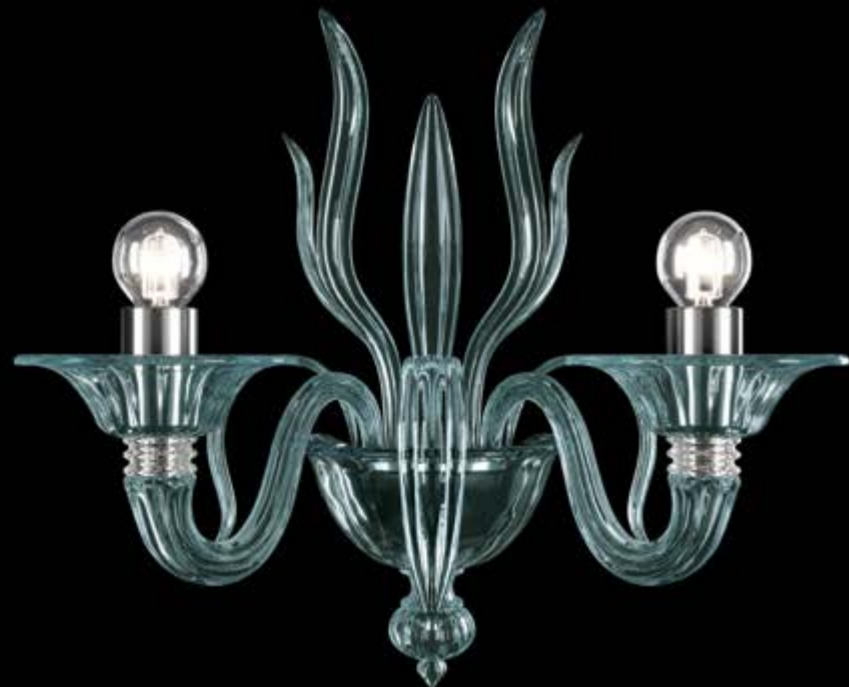

Modelli e misure Models and sizes

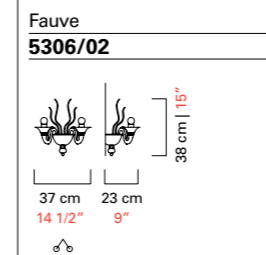

Peso Weight	2,5 kg 6 lb
Lampadine Bulbs	N. Tipo W max. 2 E14 60 N. Type W max. 2 E12 60
Dimmerabile Dimmable	D
Lampadine incluse Bulbs included	
Certificazioni Certification Marks	

Colori disponibili Available colours



CC
Cristallo
Crystal



IC
Grigio
Grey



EK
Sabbia
Sand



DK
Oliva
Olive



AK
Blu Cadetto
Cadet Blue



LQ
Bluastro
Bluastro



FK
Indaco
Indigo



CK
Pervinca
Periwinkle



VI
Viola
Violet



***OO**
Oro
Gold
*Solo OG
Only OG

Finiture Finishings



CL
Cromo Lucido
Polished Chrome



***OG**
Oro Galvanizzato
Galvanized Gold
*Solo OO
Only OO

FEZ

Le foglie ed i pendagli a oliva caratterizzano questa applique ideale per le case moderne ma perfette anche per i palazzi più lussuosi.

Leaves and olive pendants feature in this wall lamp ideal for modern houses but also perfect for more luxurious buildings.



Modelli e misure Models and sizes

Fez

5602/02

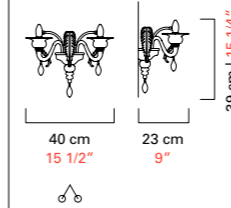

Peso

3 kg

Weight

7 lb

Lampadine

N. Tipo W max.

2 E14 60

Bulbs

N. Type W max.

E12 60

Dimmerabile

D

Dimmable

Lampadine incluse

Bulbs included

Certificazioni

Certification Marks



Colori disponibili

Available colours



CC

Cristallo
Crystal

IC

Grigio
Grey

EK

Sabbia
Sand

DK

Oliva
Olive

AK

Blu Cadetto
Cadet Blue

LQ

Bluastro
Bluastro

FK

Indaco
Indigo

CK

Perivinca
Periwinkle

VI

Viola
Violet

*OO

Oro
Gold
*Solo OG
Only OG

Finiture

Finishings



CL

Cromo Lucido
Polished Chrome

*OG

Oro Galvanizzato
Galvanized Gold
*Solo OO
Only OO

FLORIAN

I nostri archivi storici sono una miniera di ispirazioni: proprio da qui nasce Florian, una collezione di lampade a muro dalle linee retrò eppure così moderne, accentuate dai massicci paralumi in cristallo veneziano eseguiti con la tecnica del "rostrato", invenzione di Ercole Barovier che moltiplica i bagliori di luce e rende il lampadario un'opera di maestria unica.

Our historic archives provide a wealth of inspiration, and it was through them that the Florian design, collection of wall lamps, was conceived. The lines of Florian are so retro but at the same time so contemporary, accentuated by massive Venetian crystal lampshades created using the "rostrato" technique invented by Ercole Barovier, intensifying the sparkle of the lights and making this chandelier a unique piece of craftsmanship.



Modelli e misure Models and sizes

	Florian 5717/01	Florian 5717/02
Peso Weight	4 kg 9 lb	7 kg 15 lb
Lampadine N. Tipo W max. Bulbs N. Type W max.	1 E14 60 E12 60	2 E14 60 E12 60
Dimmerabile Dimmable	D	D
Lampadine incluse Bulbs included		
Certificazioni Certification Marks		

Colori disponibili Available colours



CC
Cristallo
Crystal

Finiture Finishings



CL
Cromo Lucido
Polished Chrome



CN
Cromo Nero
Dark Chrome



OF
Ottone
Spazzolato Fine
Fine Brushed Brass

GALLIA

Applique elegante ispirata alla regolarità del classico e resa senza tempo dai colori caldi e avvolgenti: il diffusore opalino è beige con pagliuzze dorate, mentre varia il colore dell'elemento sferico.

An elegant wall lamp inspired by regular, classical lines and rendered timeless by the warm and welcoming colours: the opaline diffuser is beige, speckled with gold, while the sphere element can be of different colours.



Modelli e misure Models and sizes

Gallia
5627

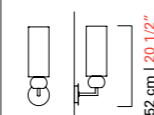

14 cm 22 cm
5 1/4" 8 1/2"

Peso Weight	4 kg 8 lb		
Lampadine Bulbs	N. N.	Tipo Type	W max. W max.
	1	E27 E26	100 60
Dimmerabile Dimmable	D		
Lampadine incluse Bulbs included			
Certificazioni Certification Marks			

Colori disponibili Available colours

*A ogni colore è sempre abbinata la foglia oro.
Each colour is always combined with gold leaf.



OO
Oro
Gold



VA
Verde Antalia
Antalia Green



NN
Nero
Black

Finiture Finishings



OG
Oro Galvanizzato
Galvanized Gold



OF
Ottone
Spazzolato Fine
Fine Brushed Brass





GRAND HOTEL

Una collezione di lampade da muro della nostra più classica produzione, dove l'elegante disegno floreale e la lavorazione realizzata con la tecnica della rugiada permettono effetti decorativi di grande suggestione.

A collection of wall lamps from our classical production. Its elegant floral design and the "rugiada" technique enable attractive and impressive decorative effects.

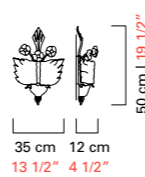
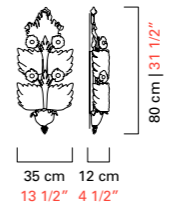
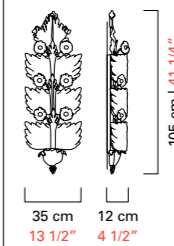

Modelli e misure Models and sizes

	Grand Hotel 4662/2	Grand Hotel 4662/4	Grand Hotel 4662/6
			
Peso Weight	3,5 kg 8 lb	6 kg 13 lb	9 kg 20 lb
Lampadine N. Tipo W max. Bulbs N. Type W max.	2 E14 60 E12 60	4 E14 60 E12 60	6 E14 60 E12 60
Dimmerabile Dimmable	D	D	D
Lampadine incluse Bulbs included			
Certificazioni Certification Marks			

Colori disponibili Available colours



CR
Cristallo Rugiada
Crystal Rugiada



OR
Oro Rugiada
Gold Rugiada

Finiture Finishings



OL
Ottone Lucido
Polished Brass

IZMIR

Forme sinuose, pendagli in cristallo trasparente e bracci in cristallo veneziano ritorto: una combinazione ideale per esaltare la lucentezza e la matericità del vetro.

Sinuous forms, pendants in transparent crystal and arms in twisted Venetian crystal: an ideal combination to embellish the brilliance and substance of the glass.



Modelli e misure Models and sizes

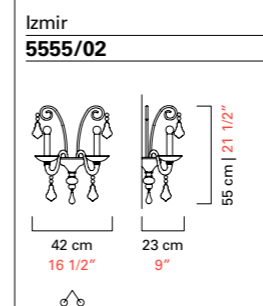

Peso Weight	2,5 kg 6 lb
Lampadine Bulbs	N. Tipo W max. N. Type W max. 2 E14 60 E12 60
Dimmerabile Dimmable	D
Lampadine incluse Bulbs included	
Certificazioni Certification Marks	

Colori disponibili Available colours

CC Cristallo Crystal	IC Grigio Grey	EK Sabbia Sand	DK Oliva Olive	AK Blu Cadetto Cadet Blue
LQ Bluastro Bluastro	FK Indaco Indigo	CK Pervinca Periwinkle	VI Viola Violet	*OO Oro Gold *Solo OG Only OG

Finiture Finishings

CL Cromo Lucido Polished Chrome	*OG Oro Galvanizzato Galvanized Gold *Solo OO Only OO

MAGRITTE

La collezione Magritte è frutto di un lavoro concettuale che indaga l'idea di lampadario fino a ripensarla e destrutturarla. Ispirata al linguaggio surrealista, si presenta con un impianto scenografico ed elegante, a più livelli, come vuole la tradizione, ma nella realtà rivela un nuovo ed avanguardistico design. La collezione include anche una versione applique, a due luci, discreta e raffinata, ideale per punteggiare le pareti di uno spazio pubblico o privato.

The Magritte collection is the result of a conceptual work that investigates the idea of a chandelier to the point of rethinking and deconstructing it. Inspired by the surrealist language, presents itself with a scenographic and elegant layout, on multiple levels, as tradition dictates, but in reality it reveals a new and avant-garde design. The collection also includes a wall sconce version with two lights; this model is discreet and refined, ideal to punctuate the walls of both public and private spaces.



Modelli e misure Models and sizes

Magritte
5721/02

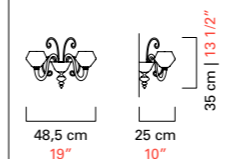

Peso Weight	5 kg 11 lb
Lampadine Bulbs	N. Tipo W max. 2 E14 60 N. Type W max. E12 60
Dimmerabile Dimmable	D
Lampadine incluse Bulbs included	
Certificazioni Certification Marks	

Colori disponibili Available colours



CC
Cristallo
Crystal



IC
Grigio
Grey



EK
Sabbia
Sand



DK
Oliva
Olive



AK
Blu Cadetto
Cadet Blue



LQ
Bluastro
Bluastro



FK
Indaco
Indigo



CK
Pervinca
Periwinkle



VI
Viola
Violet



***OO**
Oro
Gold
*Solo OG
Only OG

Finiture Finishings



CL
Cromo Lucido
Polished Chrome



***OG**
Oro Galvanizzato
Galvanized Gold
*Solo OO
Only OO

MARRAKECH

Il punto di forza di Marrakech, oltre alla versatilità di essere indifferentemente lampada da soffitto o da parete, è la sua illimitata componibilità: la forma a esagono regolare consente di affiancare senza fine le mattonelle in cristallo veneziano che caratterizzano la collezione, ciascuna con una peculiare lavorazione della superficie (fino a tre diverse). L'effetto "rugiada" applicato sul retro degli elementi, una tecnica brevettata da Barovier&Toso nel XX secolo, diffonde la luce fornita da strisce led a bassa tensione incastonate nelle strutture metalliche di sostegno.

The greatest strength of Marrakech, apart from its ability to be used either as a ceiling or wall lamp, is its limitless configuration potential: the regular hexagonal tiles allow endless additions of the Venetian crystal elements which distinguish the collection, with their different surface designs (up to three versions). The "rugiada" effect applied to the back of each element, a technique patented by Barovier&Toso in the 20th century, diffuses the light supplied by the low voltage led strips housed in the metallic support structure.

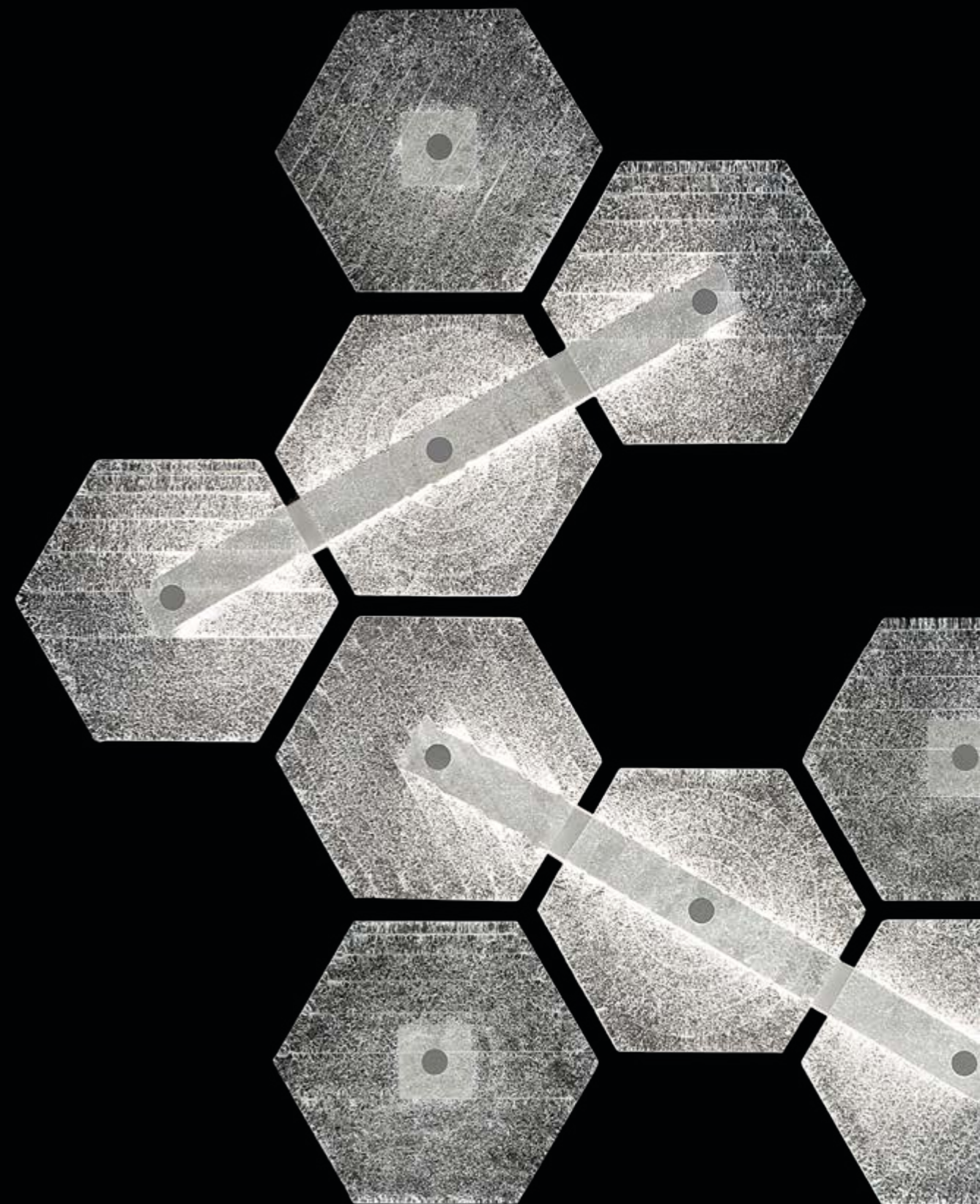
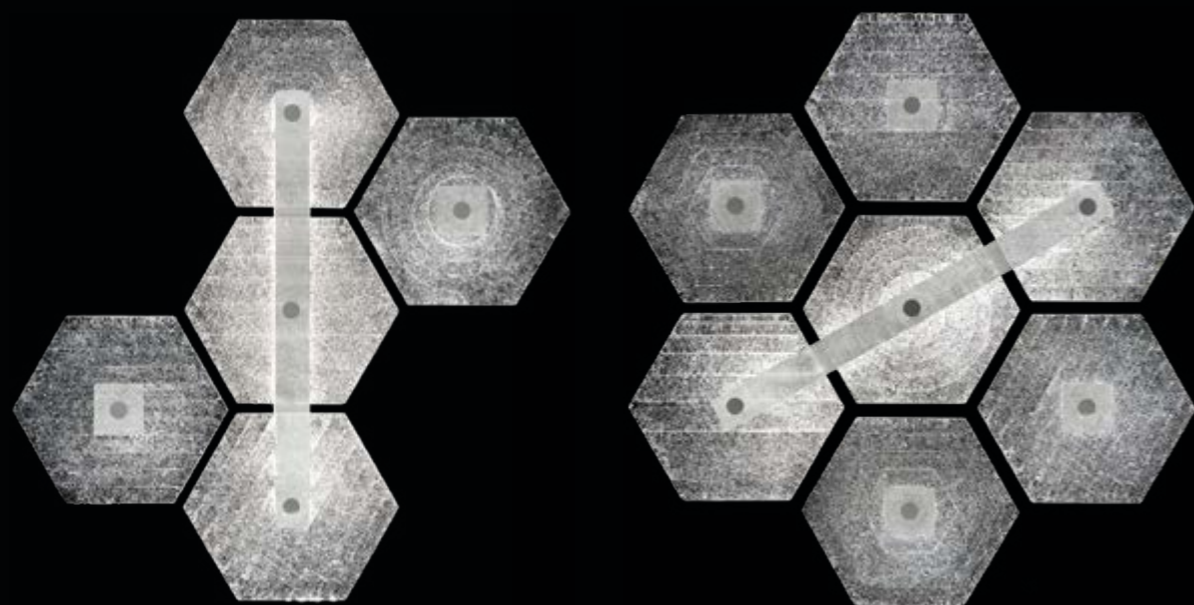

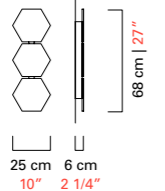
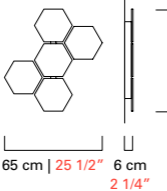
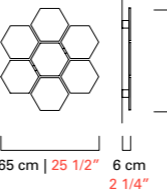
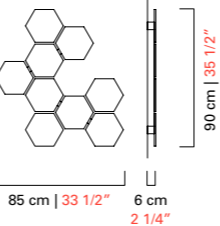
Modelli e misure <i>Models and sizes</i>	Marrakech 7367/B	Marrakech 7368/B	Marrakech 7369/B	Marrakech 7370/B
				
Peso Weight	8 kg 18 lb	12 kg 26 lb	17 kg 37 lb	21 kg 46 lb
Lampadine N. Tipo W max. Bulbs N. Type W max.	1 Strip Led 20 20	1 Strip Led 20 20	1 Strip Led 20 20	2 Strip Led 20 20
Dimmerabile Dimmable				
Lampadine incluse Bulbs included	Strip Led	Strip Led	Strip Led	Strip Led
Certificazioni Certification Marks	ERAC	ERAC	ERAC	ERAC

Colori disponibili
Available colours**CC**
Cristallo
*Crystal***Finiture**
Finishings**VG**
Verniciato Bianco
Painted White

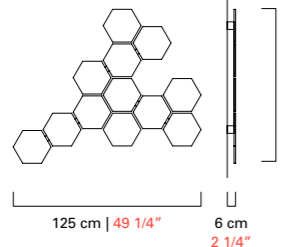
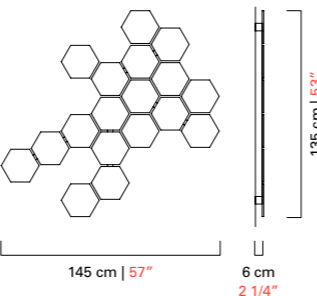
Modelli e misure <i>Models and sizes</i>	Marrakech 7371/B	Marrakech 7372/B
		
Peso Weight	28 kg 61 lb	40 kg 88 lb
Lampadine N. Tipo W max. Bulbs N. Type W max.	3 Strip Led 20 20	4 Strip Led 20 20
Dimmerabile Dimmable		
Lampadine incluse Bulbs included	Strip Led	Strip Led
Certificazioni Certification Marks	ERAC	ERAC

MARYLAND

I bracci molto sinuosi, il pendaglio a goccia, i paralumi eleganti: le lampade a muro Maryland riportano il pensiero agli eleganti palazzi neoclassici del Nuovo Continente.

Sleek curves for the arms, drop pendants and elegant shades: Maryland wall lamp collection recalls of Neoclassical buildings of the New World.

Domo Maryland design Franco Raggi

Il tradizionale fondino dove si inseriscono i bracci è sostituito da una struttura metallica dal disegno lineare.

A metal structure with a minimal design takes the place of the traditional glass chassis from where the arms depart.



Modelli e misure Models and sizes

	Maryland 5587/02	Domo Maryland 7037/01	Domo Maryland 7037/02
	<p>48 cm 19"</p> <p>25 cm 10"</p> <p>56 cm 22"</p>	<p>16 cm 6 1/4"</p> <p>34 cm 13 1/4"</p> <p>50 cm 19 1/2"</p>	<p>55 cm 21 1/2"</p> <p>24 cm 9 1/2"</p> <p>50 cm 19 1/2"</p>
Peso Weight	3 kg 7 lb	2,5 kg 6 lb	4,5 kg 10 lb
Lampadine Bulbs	N. Tipo W max. 2 E14 60 E12 60	1 E14 60 E12 60	2 E14 60 E12 60
Dimmerabile Dimmable	D	D	D
Lampadine incluse Bulbs included			
Certificazioni Certification Marks			

Colori disponibili Available colours

*Per Maryland la finitura abbinata al colore OO è sempre OG. Per Domo Maryland la finitura abbinata al colore OO può essere CL, CN o OF.
For Maryland the finishing matching colour OO is always OG. For Domo Maryland the finishings matching colour OO can be CL, CN or OF.



CC
Cristallo
Crystal



IC
Grigio
Grey



EK
Sabbia
Sand



DK
Oliva
Olive



AK
Blu Cadetto
Cadet Blue



LQ
Bluastro
Bluastro



FK
Indaco
Indigo

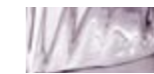

CK
Pervinca
Periwinkle

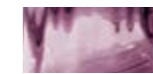

VI
Viola
Violet



***OO**
Oro
Gold
*Solo OG
Only OG

Finiture Finishings



CL
Cromo Lucido
Polished Chrome



***OG**
Oro Galvanizzato
Galvanized Gold
*Solo OO Maryland
Only OO Maryland



***CN**
Cromo Nero
Dark Chrome
*Solo Domo Maryland
Only Domo Maryland



***OF**
Ottone
Spazzolato Fine
Fine Brushed Brass
*Solo Domo Maryland
Only Domo Maryland

Paralumi Shades

Esterno: Cotone
External: Cotton

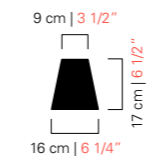

BB
Bianco
White



NN
Nero
Black



NO
Nero Interno Oro
Black Inner Gold

MATRIOSKA

Una applique caratterizzata da una montatura estremamente moderna e contemporanea. Il prezioso elemento in cristallo veneziano, chiamato "cipolla" per la sua particolare forma e per la lavorazione a costolature, diventa protagonista di un'inusuale interpretazione della lampada a muro con paralume.

A wall sconce featuring an extremely modern and contemporary assembly. The precious Venetian crystal element, known as "cipolla" due to its particular form and ribbed workmanship, becomes the protagonist of an unusual interpretation of the wall lamp with shade.



Modelli e misure Models and sizes

Matrioska
7096/01

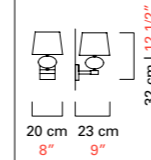

Peso Weight

2,5 kg
6 lb

Lampadine Bulbs

N.	Tipo	W max.
1	E14	60
	E12	60

Dimmerabile Dimmable

D

Lampadine incluse Bulbs included

Certificazioni Certification Marks



Colori disponibili Available colours

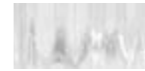

CC
Cristallo
Crystal



IC
Grigio
Grey



EK
Sabbia
Sand



DK
Oliva
Olive



AK
Blu Cadetto
Cadet Blue



LQ
Bluastro
Bluastro



FK
Indaco
Indigo



CK
Pervinca
Periwinkle



VI
Viola
Violet



OO
Oro
Gold

Finiture Finishings



CL
Cromo Lucido
Polished Chrome



CN
Cromo Nero
Dark Chrome



OF
Ottone
Spazzolato Fine
Fine Brushed Brass

Paralumi Shades

Esterno: Cotone
External: Cotton

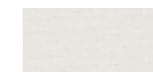
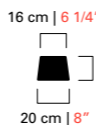

BB
Bianco
White



NN
Nero
Black



NO
Nero Interno Oro
Black Inner Gold

MEDINA

Una applique formosa, con dimensioni generose dalle linee quasi boteriane. Il collare metallico ed il paralume fuori scala caratterizzano questo oggetto.

A shapely wall sconce with generous dimensions whose design recalls somehow Botero's drawings. The metal neck and the oversize shade are distinctive of this object.



Modelli e misure Models and sizes

	Medina 5682	Medina 5683
Peso Weight	4 kg 9 lb	6 kg 13 lb
Lampadine Bulbs	N. Tipo W max. 1 E14 60	N. Tipo W max. 1 E27 100
Dimmerabile Dimmable	D	D
Lampadine incluse Bulbs included		
Certificazioni Certification Marks		

Colori disponibili Available colours

Finiture Finishings

--	--	--

Paralumi Shades

Esterno: Cotone
External: Cotton

--	--	--

MEKNES

Dall'archivio dei disegni storici di Barovier&Toso una lampada a muro della tradizione veneziana, ricca di elementi decorativi ispirati al mondo naturale. Fiori, foglie e boccioli fatti a mano rendono questo oggetto estremamente ricco e prezioso.

From the historical drawings archive of Barovier&Toso a wall lamp from the Venetian tradition, full of decorative elements inspired by nature. Hand crafted flowers, leaves and buds make this object extremely rich and precious.



Modelli e misure Models and sizes

Meknes
4797/02

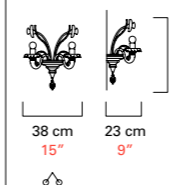

Peso Weight	3 kg 7 lb
Lampadine Bulbs	N. Tipo W max. 2 E14 60 N. Type W max. E12 60
Dimmerabile Dimmable	D
Lampadine incluse Bulbs included	
Certificazioni Certification Marks	

Colori disponibili Available colours



CC
Cristallo
Crystal



DO
Cristallo
Decoro Oro
Crystal Gold
Decoration



LQ
Cristallo
Decoro Bluastro
Crystal Bluastro
Decoration



***OO**
Oro
Gold
*Solo OG
Only OG

Finiture Finishings



CL
Cromo Lucido
Polished Chrome



***OG**
Oro Galvanizzato
Galvanized Gold
*Solo OO
Only OO

METROPOLIS

Metropolis si ispira alle atmosfere glamour ed ammalianti degli anni '20, capaci di rievocare quel vivace fermento che investì le arti visive, il design, l'architettura e la moda dell'epoca. Attingendo a quelle vibranti tendenze estetiche, che videro New York, Mosca, Berlino e Parigi trasformarsi in capitali del lusso, del divertimento e della bella vita. Una nuova collezione affascinante e raffinata, carica di una tensione espressiva intensa e sensuale.

Metropolis takes its cue from the glamorous, seductive atmospheres of the 1920s, drawing on the lively ferment in the visual arts, design, architecture and fashion in that period. Referencing the vibrant aesthetic trends that made New York, Moscow, Berlin and Paris into worldwide capitals of luxury, entertainment and lifestyle. A new collection fascinating and refined, charged with intense and sensual expressive energy.



Modelli e misure Models and sizes

Metropolis
5720/01

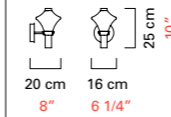

Peso Weight	3 kg 7 lb
Lampadine Bulbs	N. Tipo W max. 1+1 G9+Led 7+1,5 N. Type W max. 7+1,5
Dimmerabile Dimmable	D G9
Lampadine incluse Bulbs included	G9 Led + Led
Certificazioni Certification Marks	UL ENEC UL us

Colori disponibili Available colours



CC
Cristallo
Crystal



IC
Grigio
Grey



EK
Sabbia
Sand



DK
Oliva
Olive



AK
Blu Cadetto
Cadet Blue



LQ
Bluastro
Bluastro



FK
Indaco
Indigo

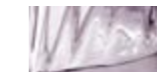

CK
Pervinca
Periwinkle

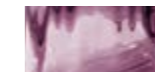

VI
Viola
Violet



OO
Oro
Gold

Finiture Finishings



NJ
Nickel Nero
Spazzolato
Brushed Black
Nickel



OJ
Oro Spazzolato
Brushed Gold

NEKHEL

Attingere alla nostra storia per farla rivivere nel mondo contemporaneo. Un'eredità preziosa che prende vita in questa applique che esalta il gusto veneziano per i fiori e per le lavorazioni complesse.

Tapping into our heritage to bring it to a new life into the contemporary world. A precious legacy that comes alive in this wall sconce that reflects the Venetian passion for flowers and complex handcrafted techniques.



Modelli e misure Models and sizes

Nekhel
5705/02

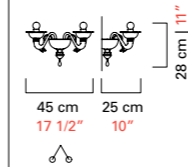

Peso

4 kg

Weight

9 lb

Lampadine

N.	Tipo	W max.	2	E14	60
Bulbs	N.	Type	W max.	E12	60

Dimmerabile

D

Dimmable

Lampadine incluse

Bulbs included

Certificazioni

Certification Marks



Colori disponibili

Available colours



CC

Cristallo
Crystal



DO

Cristallo
Decoro Oro
Crystal Gold
Decoration



LQ

Cristallo
Decoro Bluastro
Crystal Bluastro
Decoration



*OO

Oro
Gold
*Solo OG
Only OG

Finiture

Finishings



CL

Cromo Lucido
Polished Chrome



*OG

Oro Galvanizzato
Galvanized Gold
*Solo OO
Only OO

NEVADA

Arredare con una applique in cristallo veneziano di questa collezione significa donare eleganza e carattere agli ambienti, anche se di stili differenti. L'elemento caratterizzante sono i bracci rettilinei quasi privi di curvature dai quali pendono esili e delicati pendagli a forma di goccia.

Decorating with a wall lamp in Venetian crystal from this collection means adding elegance and character to spaces, even when their styles differ. The rectilinear arms, almost without curvature, are the characteristic feature, supporting slender, delicate dewdrop pendants.

Domo Nevada design Franco Raggi

Il tradizionale fondino dove si inseriscono i bracci è sostituito da una struttura metallica dal disegno lineare.





A metal structure with a minimal design takes the place of the traditional glass chassis from where the arms depart.

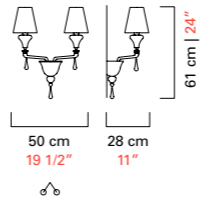
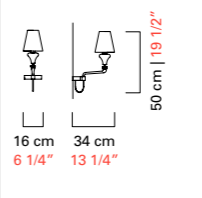
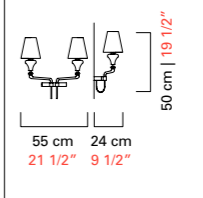

Nevada 5549/02

Domo Nevada 7031/02

Modelli e misure Models and sizes

	Nevada 5549/02	Domo Nevada 7031/01	Domo Nevada 7031/02
			
Peso Weight	3 kg 7 lb	2,5 kg 6 lb	4,5 kg 10 lb
Lampadine Bulbs	N. Tipo W max. 2 E14 60 E12 60	1 E14 60 E12 60	2 E14 60 E12 60
Dimmerabile Dimmable	D	D	D
Lampadine incluse Bulbs included			
Certificazioni Certification Marks			

Colori disponibili Available colours

*Per Nevada la finitura abbinata al colore OO è sempre OG. Per Domo Nevada la finitura abbinata al colore OO può essere CL, CN o OF.
For Nevada the finishing matching colour OO is always OG. For Domo Nevada the finishings matching colour OO can be CL, CN or OF.



				
CC Cristallo Crystal	IC Grigio Grey	EK Sabbia Sand	DK Oliva Olive	AK Blu Cadetto Cadet Blue
				
LQ Bluastro Bluastro	FK Indaco Indigo	CK Pervinca Periwinkle	VI Viola Violet	*OO Oro Gold

Finiture Finishings

			
CL Cromo Lucido Polished Chrome	*OG Oro Galvanizzato Galvanized Gold *Solo OO Nevada Only OO Nevada	*CN Cromo Nero Dark Chrome *Solo Domo Nevada Only Domo Nevada	*OF Ottone Spazzolato Fine Fine Brushed Brass *Solo Domo Nevada Only Domo Nevada

Paralumi Shades

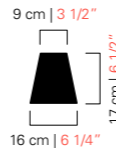
Esterno: Cotone
External: Cotton

			
	BB Bianco White	NN Nero Black	NO Nero Interno Oro Black Inner Gold

NEW FELCI

Per immergersi in una suggestiva atmosfera dallo stile déco, ammiccando al gusto glamour degli anni '20 e '30. Il fascino di una cascata di luce composta da brillanti e voluttuose foglie in cristallo veneziano delicatamente arricciate alle estremità.

For a plunge into an evocative Deco mood that takes its cue from the glamour of the 1920s and 1930s. The charm of a cascade of light composed of sparkling and voluptuous leaves of Venetian crystal, delicately curled at the extremities.



Modelli e misure Models and sizes

	New Felci 7238	New Felci 7239
Peso Weight	12 kg 26 lb	7 kg 15 lb
Lampadine Bulbs	N. Tipo W max. 2+1 E14+ E14 60+40 N. Type W max. E12+ E12 60+40	2 E14 40 E12 40
Dimmerabile Dimmable	D	D
Lampadine incluse Bulbs included		
Certificazioni Certification Marks	ERAC	ERAC

Colori disponibili Available colours



CC
Cristallo
Crystal

Finiture Finishings



CL
Cromo Lucido
Polished Chrome



OG
Oro Galvanizzato
Galvanized Gold

ODILE

Applique in cristallo veneziano realizzate a mano dai nostri esperti maestri vetrai. Queste raffinate creazioni donano eleganza e classe ad ogni tipo di ambiente, sia classico che moderno, rappresentano l'ornamento di lusso che abbina la tradizione antica al design più moderno: vere opere d'arte per illuminare al meglio gli spazi.

Wall sconces in Venetian crystal handcrafted by our expert master glassmakers. These refined creations add elegance and class to any decor, classic or modern. They represent an approach to luxury that combines an age-old tradition with the most advanced design: true works of art to brighten all kinds of spaces.



Modelli e misure Models and sizes

Odile
5307/02

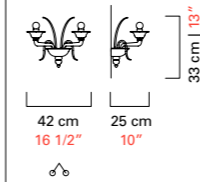

Peso Weight	2 kg 4 lb
Lampadine Bulbs	N. Tipo W max. 2 E14 60 N. Type W max. E12 60
Dimmerabile Dimmable	D
Lampadine incluse Bulbs included	
Certificazioni Certification Marks	

Colori disponibili Available colours



CC
Cristallo
Crystal



IC
Grigio
Grey



EK
Sabbia
Sand



DK
Oliva
Olive



AK
Blu Cadetto
Cadet Blue



LQ
Bluastro
Bluastro



FK
Indaco
Indigo



CK
Pervinca
Periwinkle



VI
Viola
Violet



***OO**
Oro
Gold
*Solo OG
Only OG

Finiture Finishings



CL
Cromo Lucido
Polished Chrome



***OG**
Oro Galvanizzato
Galvanized Gold
*Solo OO
Only OO

OPÉRA

Philippe Nigro

Opéra è una collezione di lampade ispirata all'Opéra Garnier, in cui l'elemento principale è la lavorazione del rostrato. La forma cilindrica va ad enfatizzare il motivo ornamentale, moltiplicando gli angoli di incidenza dei raggi luminosi e creando un fitto involuppo di punte tridimensionali. Alle creazioni in Cristallo Veneziano sono abbinati elementi metallici dalla silhouette molto affine, che circondano e sostengono i corpi luminosi. La versione applique si sviluppa in senso verticale ed è perfetta per valorizzare una parete e punteggiarla di accenti luminosi.

Opéra is a collection of lamps inspired by the Opéra Garnier, where the main feature is the rostrato. The cylindrical form underscores the ornamental motif, multiplying the angles of impact of beams of light and creating a dense wrapping of three-dimensional points. The creations in Venetian Crystal are joined by metal parts with a very similar silhouette, which surround and support the luminous volumes: completely different textures, sharing a specific inspiration in their shapes and substance. The wall sconce version develops vertically and is perfect to enhance walls, punctuating them with luminous accents.



Modelli e misure Models and sizes

Opéra
7389

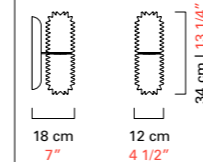

Peso

Weight

6 kg
13 lb

Lampadine

Bulbs

N.	Tipo	W max.
1	Strip Led	12

N.	Type	W max.
1	Strip Led	12

Dimmerabile

Dimmable

D

Lampadine incluse

Bulbs included

Strip Led

Certificazioni

Certification Marks



Colori disponibili

Available colours



CC

Cristallo
Crystal

Finiture

Finishings

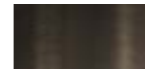

NJ

Nickel Nero
Spazzolato
Brushed Black
Nickel



OJ

Oro Spazzolato
Brushed Gold

PALLADIANO

Simmetria, ordine, perfezione ed eleganza sono le muse ispiratrici di questa collezione. Un omaggio alla razionalità e all'equilibrio delle opere del Palladio ed ai valori dell'architettura formale classica. Anche la scelta della palette cromatica con i suoi colori pieni, non trasparenti, è una celebrazione della matericità e del volume dell'oggetto che si trasforma quasi, esso stesso, in una piccola architettura.

Symmetry, order, perfection and elegance are the muses behind this collection. A tribute to the rationality and balance of the works of Palladio, and the values of formal classical architecture. The selection of colours, in full, non-transparent hues, is a celebration of the material and volume of the object, which is transformed almost into a small work of architecture.



Modelli e misure Models and sizes

Palladiano
5600/02

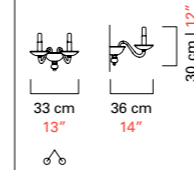

Peso

4 kg

Weight

9 lb

Lampadine

N. Tipo W max.

2

E14

60

Bulbs

N. Type W max.

E12

60

Dimmerabile

D

Dimmable

Lampadine incluse

Bulbs included

Certificazioni

Certification Marks



Colori disponibili

Available colours



CC

Cristallo
Crystal



BB

Bianco
White



NN

Nero
Black

Finiture

Finishings



CL

Cromo Lucido
Polished Chrome

PALMETTE

Una collezione che si distingue per la preziosità delle lavorazioni, rigorosamente realizzate artigianalmente e frutto di una ricerca stilistica che attinge alla storia per darne una interpretazione in chiave contemporanea. Ventagli in foglie di cristallo, sovrapposti per una rilettura intrigante dello stile déco.

A collection that stands out for precious workmanship rigorously done by hand, result of stylistic research that draws on history, granting it a contemporary interpretation. Fans of crystal leaves for an intriguing take on Art Deco.



Modelli e misure Models and sizes

Palmette
7385/1

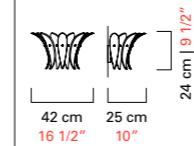

Peso

4 kg

Weight

9 lb

Lampadine

N.	Tipo	W max.
1	E14	60

Bulbs

N.	Type	W max.
	E12	40

Dimmerabile

D

Dimmable

Lampadine incluse

Bulbs included

Certificazioni

Certification Marks



Colori disponibili

Available colours



CC

Cristallo
Crystal

Finiture

Finishings



CL

Cromo Lucido
Polished Chrome



OG

Oro Galvanizzato
Galvanized Gold

PANDORA

Regala leggerezza ed un aspetto fiabesco agli interni grazie ai bracci in cristallo veneziano che sembrano fluttuare nell'aria. Il suo aspetto simile a quello di una medusa crea divertenti giochi di luce che donano profondità agli ambienti, ed il suo paralume di dimensioni importanti genera un'illuminazione omogenea ed elegante.

Interiors take on a light, fairy-tale image thanks to arms of Venetian crystal that seem to float in the air. The resemblance to a jellyfish suggests playful games of light that add depth to spaces, while the large shade generates uniform, elegant light.



Modelli e misure Models and sizes

Pandora
5675/02

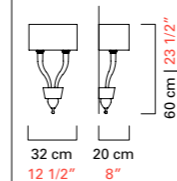

Peso Weight	3 kg 7 lb
Lampadine Bulbs	N. Tipo W max. 2+1 E14+Led 40+1,2 N. Type W max. E12+Led 40+1,2
Dimmerabile Dimmable	D E14
Lampadine incluse Bulbs included	Led
Certificazioni Certification Marks	

Colori disponibili Available colours



CC
Cristallo
Crystal



IC
Grigio
Grey



EK
Sabbia
Sand



DK
Oliva
Olive



AK
Blu Cadetto
Cadet Blue



LQ
Bluastro
Bluastro



FK
Indaco
Indigo

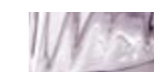

CK
Pervinca
Periwinkle



VI
Viola
Violet



OO
Oro
Gold

Finiture Finishings



CL
Cromo Lucido
Polished Chrome



CN
Cromo Nero
Dark Chrome

Paralumi Shades

Esterno: Cotone
External: Cotton



BB
Bianco
White

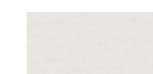

NN
Nero
Black



NO
Nero Interno Oro
Black Inner Gold

PERSEUS

Marcel Wanders Studio

Una scultura luminosa, un'emozione di luce, agli antipodi del classico. Composta da diversi elementi in cristallo veneziano che rappresentano un mix delle tecniche vetrarie reinterpretate, accostate e mescolate in modo sovversivo rispetto ai canoni della classicità.

An illuminated sculpture, a lighting emotion, a world away from the classic style. It is composed of a number of Venetian crystal elements that represent a mix of the glassmaking techniques reinterpreted, paired, and mixed in a subversive way with respect to the canons of classicism.



Modelli e misure Models and sizes

Perseus
7312

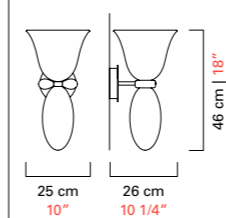

Peso Weight	4 kg 9 lb
Lampadine Bulbs	N. Tipo W max. N. Type W max.
Dimmerabile Dimmable	D
Lampadine incluse Bulbs included	G9 Led
Certificazioni Certification Marks	ERAC

Colori disponibili Available colours



BE
Bianco / Cristallo /
Cedro Liquido
White / Crystal /
Liquid Citron



BZ
Bianco / Cristallo /
Cognac
White / Crystal /
Cognac

Finiture Finishings



CL
Cromo Lucido
Polished Chrome

PIGALLE

Tradizione ed innovazione si fondono in questa collezione ispirata alla Belle Époque. Si caratterizza per eleganza e linee sinuose senza risultare eccessiva ed ostentata. Eloquente per raffinatezza e grazia alterna linee semplici, dettagli curvi e lavorazioni tradizionali.

Tradition and innovation blend in this collection inspired by the Belle Époque. It stands out for its elegant, sinuous lines, without ever seeming excessive or ostentatious. With its eloquent refinement and grace, it mixes simple lines, curved details and traditional workmanship.



Modelli e misure Models and sizes

	Pigalle 5680/01	Pigalle 5680/02
Peso Weight	4 kg 9 lb	5 kg 11 lb
Lampadine Bulbs	N. Tipo W max. 1+1 Led 8,4+8,4 8,4+8,4	N. Tipo W max. 2+1 Led 8,4+8,4 8,4+8,4
Dimmerabile Dimmable		
Lampadine incluse Bulbs included	Led	Led
Certificazioni Certification Marks		

Colori disponibili Available colours



CC
Cristallo
Crystal



OO
Oro
Gold

Finiture Finishings



CL
Cromo Lucido
Polished Chrome



CN
Cromo Nero
Dark Chrome

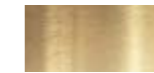

OJ
Oro Spazzolato
Brushed Gold

PIUME

Riprese dai disegni degli anni '20 e '30 del nostro archivio storico, queste applique sono un omaggio allo stile Déco. Con le loro ricche piume evocano ambientazioni lussuose e ricercate. Adatte ad ambienti estremamente decorati come anche, per contrasto, ad interni più minimali.

Resumed from drawings of the 20ies and 30ies from our historical archive, these wall lamps pay a tribute to the Déco era. With their rich feathers they evoke luxurious and refined settings. Perfect for extremely decorated ambiances as well as, playing with contrasts, for more minimal interior design projects.



Modelli e misure Models and sizes

	Piume 5390	Piume 5391	Piume 5392
Peso Weight	6 kg 13 lb	10 kg 22 lb	20 kg 44 lb
Lampadine Bulbs	N. Tipo W max. 1 E27 100 E26 60	N. Tipo W max. 2 E27 60 E26 60	N. Tipo W max. 4 E27 60 E26 60
Dimmerabile Dimmable	D	D	D
Lampadine incluse Bulbs included			
Certificazioni Certification Marks			

Colori disponibili Available colours



OB
Oro Beige
Beige Gold

Finiture Finishings



OG
Oro Galvanizzato
Galvanized Gold

PLISSÉ

Una applique direttamente ispirata dalla tradizione. Gli elementi in cristallo veneziano sono realizzati grazie a una tecnica brevettata da Barovier&Toso, che consente di ottenere un effetto striato regolare che alterna il colore pieno a quello trasparente.

A wall sconce directly inspired by the tradition. A technique patented by Barovier&Toso that allows to obtain a regular striped effect alternating matt and transparent colours on the Venetian crystal elements.



Modelli e misure Models and sizes

Plissé
6703

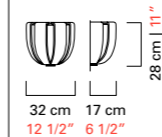

Peso

Weight

4 kg
9 lb

Lampadine

Bulbs

N.	Tipo	W max.
2	E14	60
	E12	60

Dimmerabile

Dimmable

D

Lampadine incluse

Bulbs included

Certificazioni

Certification Marks



Colori disponibili

Available colours



BB

Bianco
White

Finiture

Finishings



VG

Verniciato Bianco
Painted White

PREMIÈRE DAME

L'opulenza delle forme e dei dettagli rifulge nei pendagli di queste applique, degne delle più importanti, sontuose e ricercate dimore francesi. Con una ricchezza decorativa molto sofisticata, questa collezione si caratterizza per le diverse lavorazioni del cristallo veneziano e dei pendagli di fattura originale.

The opulence of shapes and details radiates in the pendants of these wall sconces, worthy of the most important, sumptuous and refined French residences. With its richly decorated and sophisticated design this collection is characterized by different Venetian crystal craftworks and an original pendants fabrication.



Modelli e misure Models and sizes

	Première Dame 5696/01	Première Dame 5696/02
Peso Weight	3 kg 7 lb	4 kg 9 lb
Lampadine N. Tipo W max. Bulbs N. Type W max.	1 E14 60 E12 60	2 E14 60 E12 60
Dimmerabile Dimmable	D	D
Lampadine incluse Bulbs included		
Certificazioni Certification Marks		

Colori disponibili Available colours



CC
Cristallo
Crystal



BB
Bianco
White



IC
Grigio
Grey



EK
Sabbia
Sand



DK
Oliva
Olive



LQ
Bluastro
Bluastro



FK
Indaco
Indigo



CK
Pervinca
Periwinkle



***OO**
Oro
Gold
*Solo OG
Only OG



NN
Nero
Black

Finiture Finishings



CL
Cromo Lucido
Polished Chrome



***OG**
Oro Galvanizzato
Galvanized Gold
*Solo OO
Only OO

Paralumi Shades

Nastro Pongè
Pongee Ribbon

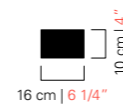

BB
Bianco
White



NN
Nero
Black

PRÉSIDENT

Applique iconiche che mettono in risalto la meticolosa eleganza della lavorazione artigianale. Prismi cesellati, pendenti scintillanti e coppette decorate le rendono elementi d'arredo davvero unici in cui il cristallo veneziano rivela il suo splendore scultoreo.

Iconic wall sconces that proudly display their painstaking workmanship and elegance. Chiselled prisms, sparkling pendants and decorated cups make this a truly unique decor feature, in which Venetian crystal reveals its sculptural splendour.



Modelli e misure Models and sizes

	Président 5695/01	Président 5695/02
Peso Weight	3 kg 7 lb	4 kg 9 lb
Lampadine Bulbs	N. Tipo W max. 1 E14 60 E12 60	N. Tipo W max. 2 E14 60 E12 60
Dimmerabile Dimmable	D	D
Lampadine incluse Bulbs included		
Certificazioni Certification Marks		

Colori disponibili Available colours



CC
Cristallo
Crystal



BB
Bianco
White



IC
Grigio
Grey



EK
Sabbia
Sand



DK
Oliva
Olive



LQ
Bluastro
Bluastro



FK
Indaco
Indigo



CK
Pervinca
Periwinkle



***OO**
Oro
Gold
*Solo OO
*Only OO



NN
Nero
Black

Finiture Finishings



CL
Cromo Lucido
Polished Chrome



***OG**
Oro Galvanizzato
Galvanized Gold
*Solo OO
*Only OO

Paralumi Shades

Esterno: Cotone
External: Cotton

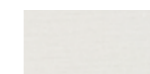
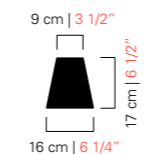

BB
Bianco
White



NN
Nero
Black



NO
Nero Interno Oro
Black Inner Gold

QUADRI

Come in un tulipano gli esili bracci sembrano voler nascondere alla vista i riccioluti pistilli che, grazie alla loro particolare lavorazione ritorta di secolare tradizione, rifrangono la luce proiettando ombre complesse.

Like in a tulip the delicate stems seem to protect the curled pistils which, thanks to the centuries-old crafting technique, refract light generating shadows with a complex texture.



Modelli e misure Models and sizes

	Quadri 5718/01	Quadri 5718/02
Peso Weight	4 kg 9 lb	7 kg 15 lb
Lampadine Bulbs	N. Tipo W max. 1 E14 60	N. Tipo W max. 2 G9 40
Dimmerabile Dimmable	D	
Lampadine incluse Bulbs included		G9 Led
Certificazioni Certification Marks		

Colori disponibili Available colours

Per il 5718/01 il colore disponibile è solo in CC.
For 5718/01 the available color is only CC.



CC
Cristallo
Crystal



IC
Grigio
Grey



EK
Sabbia
Sand



DK
Oliva
Olive



AK
Blu Cadetto
Cadet Blue



LQ
Bluastro
Bluastro



FK
Indaco
Indigo



CK
Pervinca
Periwinkle



VI
Viola
Violet



OO
Oro
Gold

Finiture Finishings



CL
Cromo Lucido
Polished Chrome

RABAT

Una applique classica, che utilizza molti degli stilemi della tradizione veneziana. In particolare, le "morise", decorazioni ondulate eseguite applicando a caldo un cordoncino di vetro pizzicato con le "borselle" (pinze) da "pissegar" (pizzicare) che consentono di ottenere una superficie che sembra un merletto.

A classical wall lamp that features many of the stylistic elements of the Venetian tradition. In particular the "morise," wavy decorations executed by applying a hot crystal ribbon and then pinching it with the "borselle" (pincers) to "pissegar" (pinching) to obtain a texture that looks like a lace.



Modelli e misure Models and sizes

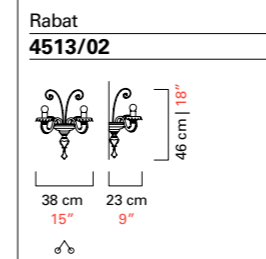

Peso Weight	3 kg 7 lb		
Lampadine Bulbs	N.	Tipo	W max.
	2	E14	60
		E12	60
Dimmerabile Dimmable	D		
Lampadine incluse Bulbs included			
Certificazioni Certification Marks			

Colori disponibili Available colours



CC
Cristallo
Crystal



DO
Cristallo
Decoro Oro
*Crystal Gold
Decoration*



LQ
Cristallo
Decoro Bluastro
*Crystal Bluastro
Decoration*



***OO**
Oro
Gold
*Solo OO
Only OO

Finiture Finishings



CL
Cromo Lucido
Polished Chrome



***OG**
Oro Galvanizzato
Galvanized Gold
*Solo OO
Only OO

RAN ROUND

Trasparenza e leggerezza. Grazie ai bracci dalle ampie curvature, alle ogive soffiare in serie e ad i pendagli a goccia di grandi dimensioni l'applicazione acquisisce una straordinaria lievità e delicatezza.

Transparency and lightness. Thanks to the wide curves of the arms, the mouth blown ogives aligned in series and the extra size drop-shaped pendants, the wall sconce appears extremely slight and delicate.



Modelli e misure Models and sizes

Ran Round

7159

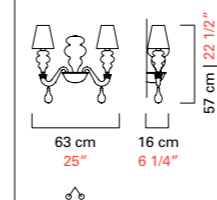

Peso Weight	4 kg 9 lb
Lampadine Bulbs	N. Tipo W max. 2 E14 60
Dimmerabile Dimmable	D
Lampadine incluse Bulbs included	
Certificazioni Certification Marks	

Colori disponibili Available colours



CC
Cristallo
Crystal



IC
Grigio
Grey



EK
Sabbia
Sand



DK
Oliva
Olive



AK
Blu Cadetto
Cadet Blue



LQ
Bluastro
Bluastro



FK
Indaco
Indigo



CK
Pervinca
Periwinkle



VI
Viola
Violet



***OO**
Oro
Gold
*Solo OG
Only OG

Finiture Finishings



CL
Cromo Lucido
Polished Chrome



***OG**
Oro Galvanizzato
Galvanized Gold
*Solo OO
Only OO

Paralumi Shades

Esterno: Cotone
External: Cotton

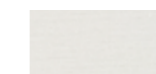
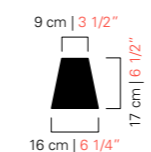

BB
Bianco
White



NN
Nero
Black



NO
Nero Interno Oro
Black Inner Gold

REDON

Una collezione di applique dalle linee sinuose ed armoniche grazie alle decorazioni a foglie delicatamente arriciate alle estremità per un richiamo al mondo naturale.

A collection of wall sconces characterized by a sinuous and harmonious design that recalls natural elements thanks to the decorations reproducing leaves gently curved at their edges.



Modelli e misure Models and sizes

	Redon 5308/02	Redon 5308/05
Peso Weight	3 kg 7 lb	7,5 kg 17 lb
Lampadine Bulbs	N. Tipo W max. 2 E14 60 E12 60	N. Tipo W max. 5 E14 60 E12 60
Dimmerabile Dimmable	D	D
Lampadine incluse Bulbs included		
Certificazioni Certification Marks		

Colori disponibili Available colours



CC
Cristallo
Crystal



IC
Grigio
Grey



EK
Sabbia
Sand



DK
Oliva
Olive



AK
Blu Cadetto
Cadet Blue



LQ
Bluastro
Bluastro



FK
Indaco
Indigo



CK
Pervinca
Periwinkle



VI
Viola
Violet



***OO**
Oro
Gold
*Solo OG
Only OG

Finiture Finishings



CL
Cromo Lucido
Polished Chrome



***OG**
Oro Galvanizzato
Galvanized Gold
*Solo OO
Only OO

REX

Petali preziosi ed elaborati che grazie all'utilizzo della tecnica della "rugiada" sembrano dei merletti fatti a mano. Applique spesso scelte all'inizio del '900 per grandi progetti di navi da crociera e alberghi di lusso sono ancora oggi dei pezzi unici capaci di donare un tocco retrò anche a progetti più contemporanei.

Precious and elaborated petals that thanks to the "rugiada" technique seem handmade laces. These wall lamps were very common at the beginning of the 20th century in big cruises and luxury hotels projects but nowadays they are still unique pieces capable to give a retrò touch also to more contemporary projects.



Modelli e misure Models and sizes

Rex
5388

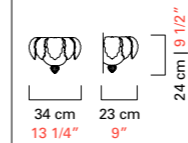

Peso Weight

5 kg
11 lb

Lampadine Bulbs

N.	Tipo	W max.	1	E27	100
				E26	60

Dimmerabile Dimmable

D

Lampadine incluse Bulbs included

Certificazioni Certification Marks



Colori disponibili Available colours



CR
Cristallo Rugiada
Crystal Rugiada



GR
Champagne Rugiada
Champagne Rugiada



OR
Oro Rugiada
Gold Rugiada

Finiture Finishings



OF
Ottone
Spazzolato Fine
Fine Brushed Brass

RIYADH

Di grande impatto scenografico, la lampada da muro Riyadh è ricca di elementi decorativi e lavorazioni a mano complesse. Un tributo al sapiente lavoro dei nostri esperti maestri vetrai. Foglie, pendagli, bossette e coppette si susseguono incessantemente in un intreccio quasi caotico per dar vita ad un disegno perfetto.

Making a highly dramatic impact, the Riyadh wall lamp is rich of decorative elements and complex handcrafted techniques. A tribute to our expert glass masters' skills. Leaves, pendants, "bossette" and cups come into an intricate, almost chaotic, succession to give birth to a perfect design.



Modelli e misure Models and sizes

Riyadh
5349/02

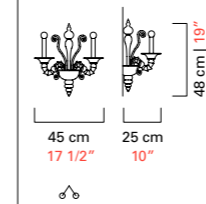

Peso
Weight

7 kg
16 lb

Lampadine N. Tipo W max.
Bulbs N. Type W max.

2 E14 60
E12 60

Dimmerabile
Dimmable

D

Lampadine incluse
Bulbs included

Certificazioni
Certification Marks



Colori disponibili Available colours



CC
Cristallo
Crystal



BB
Bianco
White



IC
Grigio
Grey



EK
Sabbia
Sand



DK
Oliva
Olive



LQ
Bluastro
Bluastro



FK
Indaco
Indigo



CK
Pervinca
Periwinkle



***OO**
Oro
Gold
*Solo OG
Only OG



NN
Nero
Black

Finiture Finishings



CL
Cromo Lucido
Polished Chrome



***OG**
Oro Galvanizzato
Galvanized Gold
*Solo OO
Only OO

ROSATI

Questa applique nasce attingendo ai disegni del prezioso archivio storico di Barovier&Toso rielaborati e riproposti con un design più moderno. Linee sobrie ed eleganti, che vanno al di là delle mode. Ogni tazza ospita al suo interno un "rostrato", piccolo gioiello di invenzione, che protegge alla vista la lampadina la cui luce si moltiplica all'infinito, passando attraverso le cuspidi che sono l'essenza stessa del rostrato.

This wall sconce takes its cue from drawings conserved in the precious historical archives of Barovier&Toso, reworked and reformulated with a more modern design. Simple, elegant lines that transcend fashion. Each candle cup holds a little stroke of genius: a "rostrato," a piece of glass with extruded pointed tips, which hides the lamps from view. Their light is refracted infinitely as it passes through the glass tips that are at the heart of the "rostrato" technique.



Modelli e misure Models and sizes

Rosati
5716/02

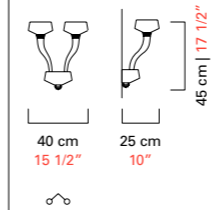

Peso Weight	5 kg 11 lb
Lampadine Bulbs	N. Tipo W max. 2+1 G9+G4 40+1,5 N. Type W max.
Dimmerabile Dimmable	D
Lampadine incluse Bulbs included	G9 Led + G4 Led
Certificazioni Certification Marks	UL ENEC UL us

Colori disponibili Available colours



CC
Cristallo
Crystal



IC
Grigio
Grey



EK
Sabbia
Sand



DK
Oliva
Olive



AK
Blu Cadetto
Cadet Blue



LQ
Bluastro
Bluastro



FK
Indaco
Indigo



CK
Pervinca
Periwinkle



VI
Viola
Violet



***OO**
Oro
Gold
*Solo OG
Only OG

Finiture Finishings



CL
Cromo Lucido
Polished Chrome



***OG**
Oro Galvanizzato
Galvanized Gold
*Solo OO
Only OO

ROTTERDAM

Bracci curvati verso l'alto e rocchetti di cristallo creati artigianalmente utilizzando un brevetto Barovier&Toso: il "rostrato". Oggetto prezioso, di straordinaria eleganza e raffinatezza capace di soddisfare un cliente esigente e sofisticato.

Arms curving upward and crystal spoons created by hand using a Barovier&Toso patent: "rostrato". A precious object of extraordinary elegance and refinement, capable of satisfying the most demanding and sophisticated customers.



Modelli e misure Models and sizes

Rotterdam
5563/02

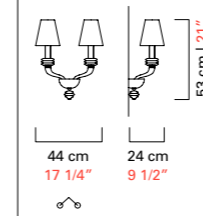

Peso Weight	4 kg 9 lb
Lampadine Bulbs	N. Tipo W max. 2 E14 60
Dimmerabile Dimmable	D
Lampadine incluse Bulbs included	
Certificazioni Certification Marks	

Colori disponibili Available colours



CC
Cristallo
Crystal



IC
Grigio
Grey



EK
Sabbia
Sand



DK
Oliva
Olive



AK
Blu Cadetto
Cadet Blue



LQ
Bluastro
Bluastro



FK
Indaco
Indigo



CK
Pervinca
Periwinkle



VI
Viola
Violet



***OO**
Oro
Gold
*Solo OG
Only OG

Finiture Finishings



CL
Cromo Lucido
Polished Chrome



***OG**
Oro Galvanizzato
Galvanized Gold
*Solo OO
Only OO

Paralumi Shades

Esterno: Cotone
External: Cotton

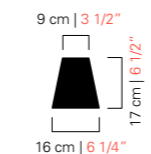

BB
Bianco
White



NN
Nero
Black



NO
Nero Interno Oro
Black Inner Gold

SAINT GERMAIN

Giorgia Brusemini

Una applique di dimensioni contenute che non perde tuttavia la poesia e l'incanto di un prodotto interamente realizzato a mano in cristallo veneziano. Elemento distintivo è la sfera realizzata con la tecnica dell'oro sommerso.

A wall sconce of compact size that do not, however, lose any of its poetry and enchantment. A product made entirely by hand in Venetian crystal, featuring a distinctive sphere made with the "oro sommerso" technique.



Modelli e misure Models and sizes

Saint Germain
7066

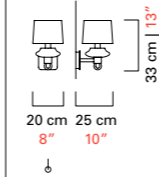

Peso Weight	4 kg 9 lb		
Lampadine Bulbs	N.	Tipo	W max.
	1	E14	60
		E12	60
Dimmerabile Dimmable	D		
Lampadine incluse Bulbs included			
Certificazioni Certification Marks			

Colori disponibili Available colours



CC
Cristallo
Crystal

Finiture Finishings



CL
Cromo Lucido
Polished Chrome



OG
Oro Galvanizzato
Galvanized Gold

Paralumi Shades

Esterno: Cotone
External: Cotton

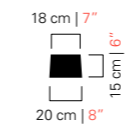

BB
Bianco
White



NN
Nero
Black



NO
Nero Interno Oro
Black Inner Gold

SAN GIORGIO

Una applique ricca di decorazioni molto particolari come i pendagli soffiati a forma di ampolla nella stessa colorazione dei bracci e le piramidi (punte attorcigliate).

Wall sconce full of specific decorations such as the ampoule shaped pendants, mouth blown in the same colour of the arms, and the pyramids (curled points).



Modelli e misure Models and sizes

San Giorgio
5558/02

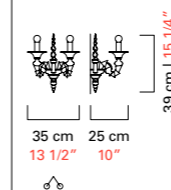

Peso Weight	2,5 kg 6 lb
Lampadine Bulbs	N. Tipo W max. 2 E14 60 N. Type W max. E12 60
Dimmerabile Dimmable	D
Lampadine incluse Bulbs included	
Certificazioni Certification Marks	

Colori disponibili Available colours



CC
Cristallo
Crystal



BB
Bianco
White



IC
Grigio
Grey



EK
Sabbia
Sand



DK
Oliva
Olive



LQ
Bluastro
Bluastro



FK
Indaco
Indigo

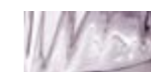

CK
Pervinca
Periwinkle



***OO**
Oro
Gold
*Solo OG
Only OG



NN
Nero
Black

Finiture Finishings



CL
Cromo Lucido
Polished Chrome



***OG**
Oro Galvanizzato
Galvanized Gold
*Solo OO
Only OO

SPADE

Collezione di applique ispirata ai fiori e alla natura che si contraddistingue per il suo delicato design a forma di corolla, realizzata con la tecnica della "rugiada" che dona un raffinato effetto ricamato. I petali si sovrappongono come a formare dei fiori schiusi, sospesi sul muro.

A collection of wall lamps with an accent on flowers and nature, which stands out for its delicate design in the form of a corolla, made with the "rugiada" technique to create a refined embroidered look. Petals overlap to form the image of a blossoming flower, suspended on the wall.



Modelli e misure Models and sizes

Spade
6747

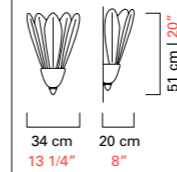

Peso
Weight

7 kg
15 lb

Lampadine N. Tipo W max.
Bulbs N. Type W max.

3 E14 60
E12 60

Dimmerabile
Dimmable

D

Lampadine incluse
Bulbs included

Certificazioni
Certification Marks



Colori disponibili Available colours



CR

Cristallo Rugiada
Crystal Rugiada

Finiture Finishings



CL

Cromo Lucido
Polished Chrome



OG

Oro Galvanizzato
Galvanized Gold



OF

Ottone
Spazzolato Fine
Fine Brushed Brass

TAIF

Sintesi perfetta di esperienze e materiali diversi, che sbalordisce per la sua ineguagliabile armonia. Una collezione di lampade da muro di grande successo, usate per arredi prestigiosi, che nasce nel 1980 per illuminare la residenza del re saudita a Taif, città da cui prende il nome. Angelo Barovier, che studia il progetto, ripensa l'immagine della tradizione muranese, preservando il valore del cristallo veneziano e accogliendo nuovi linguaggi per approdare infine all'equilibrio compiuto del Classico.

The perfect synthesis of experience and selected materials wrought with stunning and unequalled harmony. Taif was created in 1980 for the home of the Saudi king in the eponymous city of Taif, whence comes the name. Angelo Barovier, who conceived the design, rethought the image of the traditional Murano wall sconces, preserving the value of Venetian crystal while incorporating new languages. An amalgam, then, of tradition and creativity, of memory and innovation, from which blossoms the time-tested equilibrium of the classical.

Mood Taif design Franco Raggi

Il tradizionale fondino dove si inseriscono i bracci è sostituito da una struttura metallica dal disegno lineare.

A metal structure with a minimal design takes the place of the traditional glass chassis from where the arms depart.







Taif 5350/02

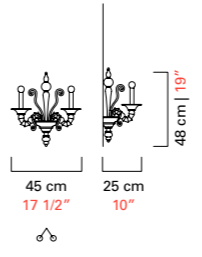
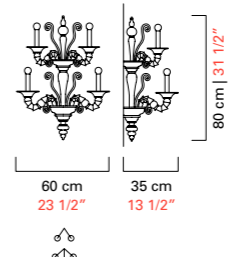
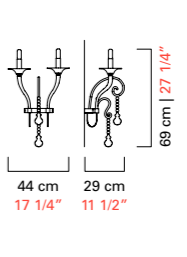

Mood Taif 7022/02

Modelli e misure Models and sizes

	Taif 5350/02	Taif 5350/05	Mood Taif 7022/02
			
Peso Weight	7 kg 15 lb	11 kg 24 lb	4,5 kg 10 lb
Lampadine Bulbs	N. Tipo W max. 2 E14 60 E12 60	5 E14 60 E12 60	2 E14 60 E12 60
Dimmerabile Dimmable	D	D	D
Lampadine incluse Bulbs included			
Certificazioni Certification Marks			

Colori disponibili Available colours

*Per Taif la finitura abbinata al colore OO è sempre OG. Per Mood Taif la finitura abbinata al colore OO può essere CL, CN o OF.
For Taif the finishing matching colour OO is always OG. For Mood Taif the finishings matching colour OO can be CL, CN or OF.



CC
Cristallo
Crystal



BB
Bianco
White



IC
Grigio
Grey



EK
Sabbia
Sand



DK
Oliva
Olive



LQ
Bluastro
Bluastro



FK
Indaco
Indigo



CK
Pervinca
Periwinkle



***OO**
Oro
Gold
*Solo OG
*Only OG



NN
Nero
Black

Finiture Finishings



CL
Cromo Lucido
Polished Chrome



***OG**
Oro Galvanizzato
Galvanized Gold
*Solo OO Taif
*Only OO Taif



***CN**
Cromo Nero
Dark Chrome
*Solo Mood Taif
*Only Mood Taif



***OF**
Ottone
Spazzolato Fine
Fine Brushed Brass
*Solo Mood Taif
*Only Mood Taif

TANGERI

Sfere riccamente decorate e pastorali abilmente ritorti si alternano in questa applique che attinge alla tradizione ma il cui disegno, alleggerito e semplificato, ben si adatta sia ad interni di gusto classico che contemporaneo.

Richly decorated spheres and gracefully curled pastorals alternate in this wall sconce that draws on the tradition while, lightening and simplifying the design, makes it perfect for both classic and contemporary settings.



Modelli e misure Models and sizes

Tangeri
5604/02

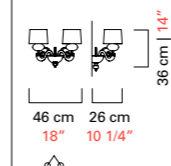

Peso
Weight

5 kg
11 lb

Lampadine N. Tipo W max.
Bulbs N. Type W max.

2 E14 60
E12 60

Dimmerabile
Dimmable

D

Lampadine incluse
Bulbs included

Certificazioni
Certification Marks



Colori disponibili Available colours



CC
Cristallo
Crystal



IC
Grigio
Grey



EK
Sabbia
Sand

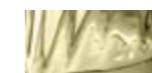

DK
Oliva
Olive



AK
Blu Cadetto
Cadet Blue



LQ
Bluastro
Bluastro



FK
Indaco
Indigo



CK
Pervinca
Periwinkle



VI
Viola
Violet



***OO**
Oro
Gold
*Solo OG
Only OG

Finiture Finishings



CL
Cromo Lucido
Polished Chrome



***OG**
Oro Galvanizzato
Galvanized Gold
*Solo OO
Only OO

Paralumi Shades

Esterno: Cotone
External: Cotton

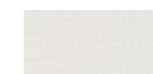
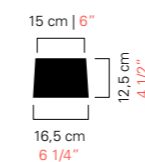

BB
Bianco
White



NN
Nero
Black



NO
Nero Interno Oro
Black Inner Gold

TAYMYR

I pendagli a bolla soffiati in cristallo veneziano e le lunghe candele dalla finitura metallica sono le peculiarità di questa applique. La lampadina di foggia cilindrica rende più moderno l'insieme.

Bubble pendants in mouth blown Venetian crystal and long metal-finish candles are the key features of this wall sconce. The cylindrical bulbs enhance the modernity of the whole.



Modelli e misure Models and sizes

Taymyr
5589/02

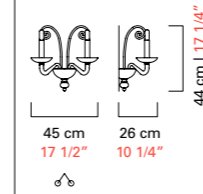

Peso Weight	3 kg 7 lb
Lampadine Bulbs	N. Tipo W max. 2 E14 60
Dimmerabile Dimmable	D
Lampadine incluse Bulbs included	
Certificazioni Certification Marks	

Colori disponibili Available colours



CC
Cristallo
Crystal



IC
Grigio
Grey



EK
Sabbia
Sand



DK
Oliva
Olive



AK
Blu Cadetto
Cadet Blue



LQ
Bluastro
Bluastro



FK
Indaco
Indigo



CK
Pervinca
Periwinkle



VI
Viola
Violet



***OO**
Oro
Gold
*Solo OG
Only OG

Finiture Finishings



CL
Cromo Lucido
Polished Chrome



***OG**
Oro Galvanizzato
Galvanized Gold
*Solo OO
Only OO

TORVIK

Una lampada da muro dal disegno classico e tradizionale che richiama le fiaccole dell'antica Grecia. Uno stelo allungato arricchito da costolature sorregge una coppetta che nasconde la fonte luminosa. Una preziosa perla funge da elemento terminale.

A wall lamp with a classical and traditional design that recalls the torches of ancient Greece. A stretched stem, enriched by the ribbing of the surface, supports a cup that hides the light source. A precious pearl serves as final element.



Modelli e misure Models and sizes

Torvik
5656

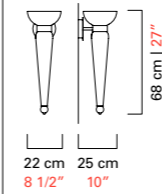

Peso Weight

4 kg
9 lb

Lampadine Bulbs

N.	Tipo	W max.		
N.	Type	W max.		
1	E14	100		
	E12	60		

Dimmerabile Dimmable

D

Lampadine incluse Bulbs included

Certificazioni Certification Marks



Colori disponibili Available colours



OO

Oro
Gold

Finiture Finishings



OG

Oro Galvanizzato
Galvanized Gold



OF

Ottone
Spazzolato Fine
Fine Brushed Brass

TUILERIES

Con una forma moderna resa tradizionale dalla tecnica della "rugiada", brevettata nel XX secolo da Barovier&Toso, Tuileries è una lampada da parete infinita: la sua perfetta simmetria consente di creare composizioni illimitate di elementi illuminati e non, sempre perfettamente combinati tra loro ed arricchiti dalla struttura metallica spazzolata in un caldo colore bronzo miele. La personalizzazione è massima, consentendo di arrivare a coprire pareti intere, quasi come un rivestimento.

With its modern form made more traditional using the "rugiada" technique, patented in the 20th century by Barovier&Toso, Tuileries is an infinite wall lamp: its perfect symmetry enables the creation of endless compositions of illuminated and non illuminated elements, always perfectly arranged and enriched by the brushed metallic structure with its warm honey bronze colour. The opportunities for personalization are limitless, allowing entire walls to be covered, almost as a sort of luxury paneling.

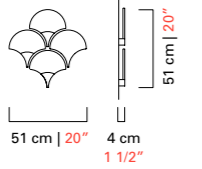
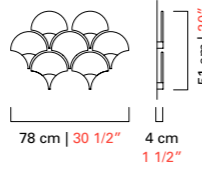
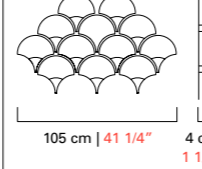
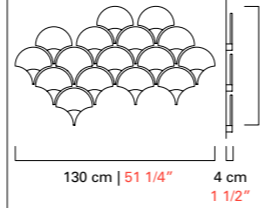

Modelli e misure
Models and sizes

	Tuileries 7373	Tuileries 7374	Tuileries 7375	Tuileries 7376
				
Peso Weight	6 kg 13 lb	10 kg 22 lb	17 kg 37 lb	23 kg 51 lb
Lampadine N. Tipo W max. Bulbs N. Type W max.	2 Strip Led 2,5 2,5	3 Strip Led 2,5 2,5	5 Strip Led 2,5 2,5	7 Strip Led 2,5 2,5
Dimmerabile Dimmable				
Lampadine incluse Bulbs included	Strip Led	Strip Led	Strip Led	Strip Led
Certificazioni Certification Marks	ERAC	ERAC	ERAC	ERAC

Colori disponibili
Available colours

CC
Cristallo
Crystal

Finiture
Finishings

OZ
Bronzo Miele
Honey Bronze

Modelli e misure
Models and sizes

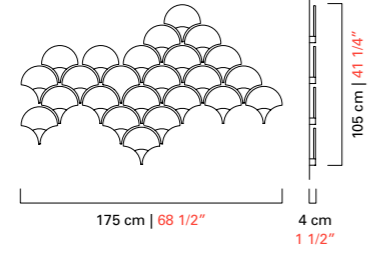
	Tuileries 7377
	
Peso Weight	33 kg 73 lb
Lampadine N. Tipo W max. Bulbs N. Type W max.	9 Strip Led 2,5 2,5
Dimmerabile Dimmable	
Lampadine incluse Bulbs included	Strip Led
Certificazioni Certification Marks	ERAC

TWINS

Come in un passato mai passato la materia vetro prende forma, e la luce si alterna alle ombre in un vigoroso abbraccio vorticante. Una lampada da muro dall'aspetto vigoroso ma raffinato. Il cristallo dei bracci, molto materico, è trasparente mentre le lampade sono racchiuse in tazzine di colore bianco opaco che diffonde e ammorbidisce la luce.

In a past that is ever present, the glass takes shape and light alternates with shadows to generate a vigorous, vertiginous embrace. A wall lamp with a vigorous yet refined appearance. The arms' crystal, which is very material, is transparent, while the light bulbs are enclosed in opaque white cups which diffuse and soften the light.



Modelli e misure Models and sizes

Twins
7225/02

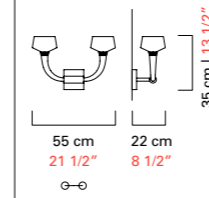

Peso Weight	4 kg 9 lb				
Lampadine Bulbs	N.	Tipo	W max.		
	2	G9	40		
Dimmerabile Dimmable	D				
Lampadine incluse Bulbs included	G9 Led				
Certificazioni Certification Marks	EAC				

Colori disponibili Available colours



CC
Cristallo
Crystal



OO
Oro
Gold

Finiture Finishings



CL
Cromo Lucido
Polished Chrome



CN
Cromo Nero
Dark Chrome



OF
Ottone
Spazzolato Fine
Fine Brushed Brass

VALIANT

Un disegno anni '20, linee pulite e solo alcuni elementi decorativi. Un oggetto essenziale che non passa mai di moda particolarmente adatto ad ambienti contemporanei.

A drawing from the 20ies, clean lines and just few decorative elements. An essential object that never goes out of fashion particularly suitable for contemporary interiors.



Modelli e misure Models and sizes

	Valiant 5507/02	Valiant 5507/05
Peso Weight	2 kg 4 lb	4 kg 9 lb
Lampadine N. Tipo W max. Bulbs N. Type W max.	2 E14 60 E12 60	5 E14 60 E12 60
Dimmerabile Dimmable	D	D
Lampadine incluse Bulbs included		
Certificazioni Certification Marks		

Colori disponibili Available colours



CC
Cristallo
Crystal



IC
Grigio
Grey



EK
Sabbia
Sand



DK
Oliva
Olive



AK
Blu Cadetto
Cadet Blue



LQ
Bluastro
Bluastro



FK
Indaco
Indigo



CK
Pervinca
Periwinkle



VI
Viola
Violet



***OO**
Oro
Gold
*Solo OO
Only OO

Finiture Finishings



CL
Cromo Lucido
Polished Chrome



***OG**
Oro Galvanizzato
Galvanized Gold
*Solo OO
Only OO

VENEZIA 1295

L'origine di tutto, il compendio di settecento anni di tradizioni tramandate di padre in figlio, oltre le mode e il tempo che scorre: una applique ricca di storia, di dettagli e di emozioni. Caratterizzata da un elemento ricorrente, il "rostrato", un'invenzione del secolo scorso di Ercole Barovier che prende origine dalle tecniche di lavorazione artigianali dei suoi avi.

At the very heart of it all is the culmination of seven hundred years of tradition handed down from father to son through changing times and fashions: a wall sconce rich in history, detail and emotion. Featuring a recurring motif, the "rostrato," invented by Ercole Barovier almost a century ago developing techniques used by his ancestors.



Modelli e misure Models and sizes

Venezia 1295

5715/02

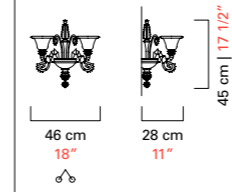

Peso

Weight

8 kg
18 lb

Lampadine

Bulbs

N.	Tipo	W max.
2	G9	40

Dimmerabile

Dimmable

Lampadine incluse

Bulbs included

G9 Led

Certificazioni

Certification Marks



Colori disponibili

Available colours

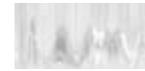

CC

Cristallo
Crystal

Finiture

Finishings



CL

Cromo Lucido
Polished Chrome



OG

Oro Galvanizzato
Galvanized Gold

VERMONT

Elemento caratterizzante di questa collezione di lampade da muro sono le grandi sfere in cristallo veneziano soffiato. Insieme ai bracci morbidamente ricurvi generano un'eterea ma preziosa nuvola di vetro.

The large Venetian crystal spheres are the distinctive elements of this collection. Along with the softly curved arms, they generate an ethereal but at the same time precious crystal cloud.



Modelli e misure Models and sizes

	Vermont 5550/02	Vermont 5550/05
Peso Weight	4 kg 9 lb	7 kg 16 lb
Lampadine Bulbs	N. Tipo W max. 2 E14 60 E12 60	N. Tipo W max. 5 E14 60 E12 60
Dimmerabile Dimmable	D	D
Lampadine incluse Bulbs included		
Certificazioni Certification Marks		

Colori disponibili Available colours



CC
Cristallo
Crystal



IC
Grigio
Grey



EK
Sabbia
Sand



DK
Oliva
Olive



AK
Blu Cadetto
Cadet Blue



LQ
Bluastro
Bluastro



FK
Indaco
Indigo



CK
Pervinca
Periwinkle



VI
Viola
Violet



***OO**
Oro
Gold
*Solo OG
Only OG

Finiture Finishings



CL
Cromo Lucido
Polished Chrome



***OG**
Oro Galvanizzato
Galvanized Gold
*Solo OO
Only OO

Paralumi Shades

Esterno: Cotone
External: Cotton

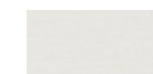
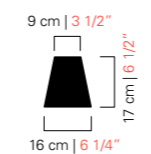

BB
Bianco
White



NN
Nero
Black



NO
Nero Interno Oro
Black Inner Gold

VERTIGO

Vertigo si ispira alle atmosfere glamour ed ammalianti degli anni '20, capaci di rievocare quel vivace fermento che investì le arti visive, il design, l'architettura e la moda dell'epoca. Attingendo a quelle vibranti tendenze estetiche, che videro New York, Mosca, Berlino e Parigi trasformarsi in capitali del lusso, del divertimento e della bella vita. Una nuova collezione affascinante e raffinata, carica di una tensione espressiva intensa e sensuale.

Vertigo takes its cue from the glamorous, seductive atmospheres of the 1920s, drawing on the lively ferment in the visual arts, design, architecture and fashion in that period. Referencing the vibrant aesthetic trends that made New York, Moscow, Berlin and Paris into worldwide capitals of luxury, entertainment and lifestyle. A new collection fascinating and refined, charged with intense and sensual expressive energy.



Modelli e misure Models and sizes

	Vertigo 5719/01	Vertigo 5719/02
Peso Weight	3 kg 7 lb	5 kg 11 lb
Lampadine Bulbs	N. Tipo W max. 1+1 G9+Led 7+1,5 N. Type W max. 7+1,5	2+1 G9+G4 7+1,5 7+1,5
Dimmerabile Dimmable	D G9	D G9
Lampadine incluse Bulbs included	G9 Led + Led	G9 Led + G4 Led
Certificazioni Certification Marks		

Colori disponibili Available colours



CC
Cristallo
Crystal



IC
Grigio
Grey



EK
Sabbia
Sand



DK
Oliva
Olive



AK
Blu Cadetto
Cadet Blue



LQ
Bluastro
Bluastro



FK
Indaco
Indigo



CK
Perwinka
Perwinkle



VI
Viola
Violet



OO
Oro
Gold

Finiture Finishings



NJ
Nickel Nero
Spazzolato
Brushed Black
Nickel



OJ
Oro Spazzolato
Brushed Gold

WINDSOR

Bracci sinuosi ed eleganti, che si dipanano dal fondino centrale. Le tazzine portalampana sono sempre bianco opaco con una sfumatura nella stessa tonalità dei bracci.

Sinuous, elegant arms which unfurl from the central chassis. The lamp-holder cups are always opaque white with a shade whose tonality is the same as the arms.



Modelli e misure Models and sizes

Windsor
5676/02

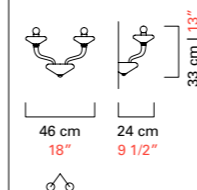

Peso Weight	3 kg 7 lb
Lampadine Bulbs	N. Tipo W max. 2 E14 60 E12 60
Dimmerabile Dimmable	D
Lampadine incluse Bulbs included	
Certificazioni Certification Marks	UL CCC ENEC UL us

Colori disponibili Available colours



CC
Cristallo
Crystal



IC
Grigio
Grey



EK
Sabbia
Sand



DK
Oliva
Olive



AK
Blu Cadetto
Cadet Blue



LQ
Bluastro
Bluastro



FK
Indaco
Indigo



CK
Pervinca
Periwinkle



VI
Viola
Violet



***OO**
Oro
Gold
*Solo OG
Only OG

Finiture Finishings



CL
Cromo Lucido
Polished Chrome



***OG**
Oro Galvanizzato
Galvanized Gold
*Solo OO
Only OO



TABLE

Sofisticated presences, detentrici di scultorea lucentezza, avvolgono lo spazio di luce soffusa. Espressione di molteplici personalità, i diversi design sono modulati per ogni occasione. In comune, la capacità di connotare l'intorno dipingendo angoli caldi ed accoglienti.

Sophisticated presences, formulations of sculptural radiance, they wrap spaces in soft light. Expressing multiple personalities, the various designs are gauged to suit all occasions. They share in the ability to add character to their surroundings, producing warm, welcoming corners.

AMSTERDAM

Una lampada da tavolo che si caratterizza per il rostrato di cristallo, come il lampadario omonimo di cui è naturale complemento. Eleganza pragmatica impreziosita da un tocco unico della tradizione vetraria di Venezia.

A table lamp that is characterized by the crystal "rostrato", like the homonymous chandelier of which it is natural complement. Pragmatic elegance enriched by the unique touch of the Venetian glass-blowing tradition.



Modelli e misure Models and sizes

Amsterdam
5564

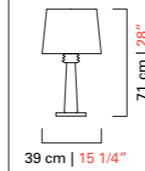

Peso Weight	6 kg 13 lb
Lampadine Bulbs	N. Tipo W max. 1 E27 100 N. Type W max. E26 60
Dimmerabile Dimmable	D
Lampadine incluse Bulbs included	
Certificazioni Cerification Marks	

Colori disponibili Available colours



CC
Cristallo
Crystal



IC
Grigio
Grey



EK
Sabbia
Sand



DK
Oliva
Olive



AK
Blu Cadetto
Cadet Blue



LQ
Bluastro
Bluastro



FK
Indastro
Indigo



CK
Pervinca
Periwinkle



VI
Viola
Violet



OO
Oro
Gold

Finiture Finishings



CL
Cromo Lucido
Polished Chrome



CN
Cromo Nero
Dark Chrome



OF
Ottone
Spazzolato Fine
Fine Brushed Brass

Paralumi Shades

Esterno: Cotone
External: Cotton

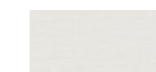
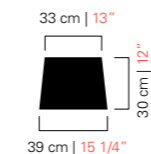

BB
Bianco
White



NN
Nero
Black



NO
Nero Interno Oro
Black Inner Gold

CAMPARINO

Camparino è una lampada da tavolo wireless elegante e raffinata che racchiude passato e presente in un unico elemento di dimensioni ridotte: da un lato interpreta la tradizione muranese utilizzando la tecnica del "rostrato", dall'altro sintetizza l'idea di modernità impiegando un sistema di alimentazione a batteria al litio ricaricabile, che la rende trasportabile ovunque, e una tecnologia che consente l'accensione, lo spegnimento e la regolazione dell'intensità luminosa con una manopola di controllo del dimmer in ottone spazzolato. Ha una base in marmo pregiato, in due varianti: Bianco Carrara e Nero Belgio.

Camparino is an elegant, sophisticated wireless table lamp that brings together past and present in a single, compact piece. On the one hand it reflects Murano glassmaking tradition, in that it uses the "rostrato" technique; on the other, it represents the ultimate in modernity: its rechargeable lithium battery allows it to be transported anywhere, while wireless technology means that it can be turned on or off and its brightness adjusted with just a movement of the brushed brass dimmer control knob.

The base is in precious marble, in two options: White Carrara and Belgian Black.



Modelli e misure Models and sizes

Camparino
7358

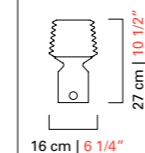

Peso Weight	4 kg 9 lb
Lampadine Bulbs	N. Tipo W max. 1 Led 6 N. Type W max. 6
Dimmerabile Dimmable	D
Lampadine incluse Bulbs included	Led
Certificazioni Certification Marks	

Colori disponibili Available colours



CC
Cristallo
Crystal

Finiture Finishings



MW
Marmo Bianco
White Marble



MB
Marmo Nero
Black Marble

ERCOLE

Ispirata a un'idea originale di Ercole Barovier risalente agli anni '40 del Novecento e realizzata con l'allora innovativa tecnica del "rostrato", questa lampada da tavolo è disponibile in due dimensioni differenti: la più grande è provvista di sorgente luminosa anche all'interno della base, con accensione separata.

Inspired by an original idea by Ercole Barovier in the 1940s and created using the "rostrato" technique he had just invented, this table lamp is available in different sizes: the bigger of the two includes an additional light source inside the base, controlled separately.



Modelli e misure Models and sizes

	Ercole 7356	Ercole 7357																		
Peso Weight	6 kg 13 lb	9 kg 20 lb																		
Lampadine Bulbs	<table border="1"> <thead> <tr> <th>N.</th> <th>Tipo</th> <th>W max.</th> </tr> </thead> <tbody> <tr> <td>1</td> <td>E14</td> <td>60</td> </tr> <tr> <td></td> <td>E12</td> <td>60</td> </tr> </tbody> </table>	N.	Tipo	W max.	1	E14	60		E12	60	<table border="1"> <thead> <tr> <th>N.</th> <th>Tipo</th> <th>W max.</th> </tr> </thead> <tbody> <tr> <td>1+1</td> <td>E27+G9</td> <td>60+1,5</td> </tr> <tr> <td></td> <td>E26+G9</td> <td>7+1,5</td> </tr> </tbody> </table>	N.	Tipo	W max.	1+1	E27+G9	60+1,5		E26+G9	7+1,5
N.	Tipo	W max.																		
1	E14	60																		
	E12	60																		
N.	Tipo	W max.																		
1+1	E27+G9	60+1,5																		
	E26+G9	7+1,5																		
Dimmerabile Dimmable	D	D																		
Lampadine incluse Bulbs included		E27 Led + G9 Led																		
Certificazioni Certification Marks																				

Colori disponibili Available colours



CC
Cristallo
Crystal

Finiture Finishings



CL
Cromo Lucido
Polished Chrome

EVA

Le grandi ogive sospese identificano questa lampada estremamente moderna. La leggerezza è la caratteristica principale che la rende adatta ad ogni progetto di interni.

The great hanging ogives identify this modern table lamp. Lightness is the main feature which makes it suitable for any interior design project.



Modelli e misure Models and sizes

Eva
7056

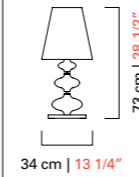

Peso Weight

7 kg
15 lb

Lampadine Bulbs

N.	Tipo	W max.
1	E27	100
	E26	60

Dimmerabile Dimmable

D

Lampadine incluse Bulbs included

Certificazioni Certification Marks



Colori disponibili Available colours



CC
Cristallo
Crystal



IC
Grigio
Grey



EK
Sabbia
Sand



DK
Oliva
Olive



AK
Blu Cadetto
Cadet Blue



LQ
Bluastro
Bluastro



FK
Indaco
Indigo



CK
Periwinkle
Periwinkle



VI
Viola
Violet



OO
Oro
Gold

Finiture Finishings



CN
Cromo Nero
Dark Chrome



OF
Ottone
Spazzolato Fine
Fine Brushed Brass

Paralumi Shades

Esterno: Cotone
External: Cotton

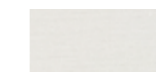
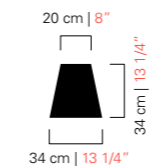

BB
Bianco
White



NN
Nero
Black



NO
Nero Interno Oro
Black Inner Gold

GALLIA

Una lampada da tavolo elegante ispirata ai canoni classici della simmetria e delle proporzioni, resa senza tempo dai colori caldi e avvolgenti: il diffusore opalino è beige, con pagliuzze dorate, mentre varia il colore dell'elemento sferico detto "cipolla".

An elegant table lamp inspired by the classical canons of symmetry and proportions, rendered timeless by the warm and caressing colours: the opaline diffuser is beige, speckled with gold, while the sphere part, called "cipolla" can be of different colours.



Modelli e misure Models and sizes

Gallia
5625

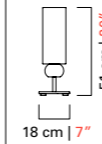

18 cm | 7"

Peso
Weight

6 kg
13 lb

Lampadine N. Tipo W max.
Bulbs N. Type W max.

1	E27	100
	E26	60

Dimmerabile
Dimmable

D

Lampadine incluse
Bulbs included

Certificazioni
Certification Marks



Colori disponibili Available colours

A ogni colore è sempre abbinata la foglia oro.
Each colour is always combined with gold leaf.



OO
Oro
Gold

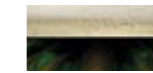

VA
Verde Antalia
Antalia Green



NN
Nero
Black

Finiture Finishings



OG
Oro Galvanizzato
Galvanized Gold



OF
Ottone
Spazzolato Fine
Fine Brushed Brass

GRACE

Philippe Nigro

Fiera ed elegante come una principessa dall'eterna bellezza, la collezione Grace è permeata da un gentile fascino classico. Eclettica la struttura, che mutua dal lampadario tradizionale muranese il sistema del diffusore: ecco che la coppetta cresce di scala e diventa un ampio calice, che accoglie ed esalta la preziosità dell'elemento luminoso al suo interno, realizzato in rostrato. Sopraffine anche le tecniche con le quali viene creato il tronco, percorso da suggestive bolle racchiuse tra due strati di vetro, cromaticamente distinti. L'effetto finale è lucente, ed è il risultato di una complessa sequenza di lavorazioni, dal ballotton sommerso fino alla specchiatura.

Proud and elegant as a princess of eternal beauty, the Grace collection is permeated by genteel classic charm. The structure is eclectic, borrowing the diffuser system from the traditional Murano chandelier: the cup grows in size and becomes a large goblet that contains and enhances the luminous element inside it, made with the rostrato technique. The methods utilized to create the trunk, crossed by evocative bubbles enclosed between two layers of glass, in separate colours, are equally sophisticated. The final effect is dazzling, the result of a complex sequence of workmanship, from dipped ballotton to mirror finishing.

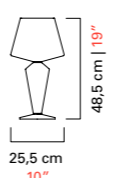
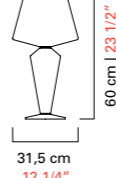

Modelli e misure Models and sizes

	Grace 7430	Grace 7431
		
Peso Weight	7 kg 15 lb	10 kg 22 lb
Lampadine Bulbs	N. Tipo W max. 1 G9+Led 7	N. Tipo W max. 1 G9+Led 7
Dimmerabile Dimmable	D G9	D G9
Lampadine incluse Bulbs included	G9 Led	G9 Led
Certificazioni Certification Marks		

Colori disponibili Available colours



CC
Cristallo
Crystal



DK
Oliva
Olive



AK
Blu Cadetto
Cadet Blue



LQ
Bluastro
Bluastro



VI
Viola
Violet



VA
Verde Antalia
Antalia Green



BW
Brown
Brown

Finiture Finishings



OJ
Oro Spazzolato
Brushed Gold



CN
Cromo Nero
Dark Chrome

MARTA

Una lampada da tavolo con un fusto molto esile ed una sfera in cristallo veneziano lavorata con la tradizionale tecnica a "corteccia". La massa vetrosa ancora calda viene fatta rotolare abilmente su di uno stampo piatto a lamelle e poi, successivamente, soffiata per ottenere una superficie irregolare e tridimensionale che ricorda quella della corteccia di un albero.

A table lamp with a very slender stem bearing a Venetian crystal sphere worked with the traditional "corteccia" technique. The hot glass is skilfully turned on a flat lamellar plate and then blown to obtain an irregular three-dimensional surface, resembling the bark of a tree.



Modelli e misure Models and sizes

Marta
5576

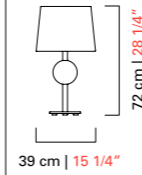

Peso Weight	5 kg 11 lb
Lampadine Bulbs	N. Tipo W max. N. Type W max. 1 E27 100 E26 100
Dimmerabile Dimmable	D
Lampadine incluse Bulbs included	
Certificazioni Certification Marks	

Colori disponibili Available colours



CC
Cristallo
Crystal



IC
Grigio
Grey



EK
Sabbia
Sand



DK
Oliva
Olive



AK
Blu Cadetto
Cadet Blue



LQ
Bluastro
Bluastro



FK
Indaco
Indigo



CK
Pervinca
Periwinkle



VI
Viola
Violet



OO
Oro
Gold

Finiture Finishings



CL
Cromo Lucido
Polished Chrome



CN
Cromo Nero
Dark Chrome



OF
Ottone
Spazzolato Fine
Fine Brushed Brass

Paralumi Shades

Esterno: Cotone
External: Cotton

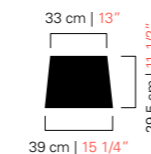

BB
Bianco
White



NN
Nero
Black



NO
Nero Interno Oro
Black Inner Gold



MEDINA

Una collezione formosa, con dimensioni generose dalle linee quasi boteriane. Il collare metallico ed i paralumi fuori scala caratterizzano l'intera linea.

A shapely collection with generous dimensions whose design recalls somehow Botero's drawings. The metal neck and the oversize shades are distinctive of the entire line.

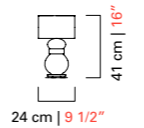
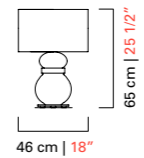

Modelli e misure Models and sizes

	Medina 5685	Medina 5686
		
Peso Weight	4 kg 9 lb	7 kg 15 lb
Lampadine Bulbs	N. Tipo W max. 1 E14 60 E12 60	N. Tipo W max. 1 E27 100 E26 100
Dimmerabile Dimmable	D	D
Lampadine incluse Bulbs included		
Certificazioni Certification Marks		

Colori disponibili Available colours



CC
Cristallo
Crystal



IC
Grigio
Grey



EK
Sabbia
Sand

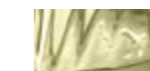

DK
Oliva
Olive



AK
Blu Cadetto
Cadet Blue



LQ
Bluastro
Bluastro



FK
Indaco
Indigo

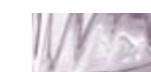

CK
Pervinca
Periwinkle



VI
Viola
Violet



OO
Oro
Gold

Finiture Finishings



CL
Cromo Lucido
Polished Chrome



CN
Cromo Nero
Dark Chrome



OF
Ottone
Spazzolato Fine
Fine Brushed Brass

Paralumi Shades

Esterno: Cotone
External: Cotton



BB
Bianco
White



NN
Nero
Black

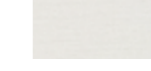

NO
Nero Interno Oro
Black Inner Gold

MY MARYLIN

Giorgia Brusemini

Il diffusore è in vetro bianco opalino mentre preziosi rocchetti di cristallo realizzati a mano con la tecnica del "rostrato" avvolgono la base della lampada.

The diffuser is made of white opaline glass while precious crystal spools, handmade with the "rostrato" technique, wrap around the base of the lamp.



Modelli e misure Models and sizes

	My Marilyn 6997	My Marilyn 6998
Peso Weight	9 kg 20 lb	12 kg 26 lb
Lampadine Bulbs	N. Tipo W max. 1 E27 100 E26 100	N. Tipo W max. 1 E27 100 E26 100
Dimmerabile Dimmable	D	D
Lampadine incluse Bulbs included		
Certificazioni Certification Marks		

Colori disponibili Available colours



CC
Cristallo
Crystal

Finiture Finishings



VM
Verniciato Mirra
Painted Myrrh



VN
Verniciato Nero
Painted Black

OPÉRA

Philippe Nigro

Opéra è una collezione di lampade ispirata all'Opéra Garnier, in cui l'elemento principale è la lavorazione del rostrato. La forma cilindrica va ad enfatizzare il motivo ornamentale, moltiplicando gli angoli di incidenza dei raggi luminosi e creando un fitto involuppo di punte tridimensionali. Alle creazioni in Cristallo Veneziano sono abbinati elementi metallici dalla silhouette molto affine, che circondano e sostengono i corpi luminosi. Il modello da tavolo presenta un'estetica ancora più avvolgente, capace di creare, anche da spenta, un'atmosfera calda e preziosa.

Opéra is a collection of lamps inspired by the Opéra Garnier, where the main feature is the rostrato. The cylindrical form underscores the ornamental motif, multiplying the angles of impact of beams of light and creating a dense wrapping of three-dimensional points. The creations in Venetian Crystal are joined by metal parts with a very similar silhouette, which surround and support the luminous volumes: completely different textures, sharing a specific inspiration in their shapes and substance. The table model has an even more enveloping look, and is able to create a warm, precious atmosphere even when the lamp is off.



Modelli e misure Models and sizes

Opéra
7391

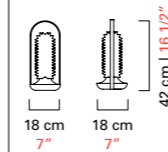

Peso Weight	8 kg 18 lb
Lampadine Bulbs	N. Tipo W max. 1 Strip Led 10 N. Type W max. Strip Led 10
Dimmerabile Dimmable	D Not dimmable for the USA version
Lampadine incluse Bulbs included	Strip Led
Certificazioni Certification Marks	

Colori disponibili Available colours



CC
Cristallo
Crystal

Finiture Finishings



NJ
Nickel Nero
Spazzolato
Brushed Black
Nickel



OJ
Oro Spazzolato
Brushed Gold



PADMA

Collezione disegnata per esprimere armonia, sintesi tra le parti, sinergia tra contrasti. L'ampolla esterna presenta un design molto pulito, ottenuto con un'unica soffiata e una graduale sfumatura di colore, risultato di un sapiente gesto artigianale. Gli altri elementi, invece, finemente lavorati con la tipica tecnica muranese delle costolature, hanno delle forme complesse e sofisticate.

This collection is designed to express harmony, a synthesis of parts, a synergy of contrasts. The external ampoule has a very clean design, made in a single blowing, and a gradually shaded colour, produced by the skillful gesture of the artisan. The other parts, finely crafted with the typical Murano ribbing technique, have complex, sophisticated forms.

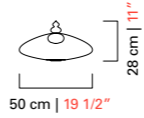

Modelli e misure Models and sizes

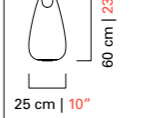
	Padma 7378	Padma 7380	Padma 7382
			
Peso Weight	8 kg 15 lb	8 kg 15 lb	8 kg 15 lb
Lampadine Bulbs	N. Tipo W max. 1 Led 10 N. Type W max. 1 Led 10	N. Tipo W max. 1 Led 10 N. Type W max. 1 Led 10	N. Tipo W max. 1 Led 10 N. Type W max. 1 Led 10
Dimmerabile Dimmable	D	D	D
Lampadine incluse Bulbs included	Led	Led	Led
Certificazioni Certification Marks	EAC	EAC	EAC

Colori disponibili Available colours

Diffusore
Diffuser



BB
Bianco Sfumato
Shaded White



IC
Grigio Sfumato
Shaded Grey

Colori disponibili Available colours

Dettaglio decorativo
Decorative detail



CC
Cristallo
Crystal



BB
Bianco
White



IC
Grigio
Grey



EK
Sabbia
Sand



DK
Oliva
Olive



LQ
Bluastro
Bluastro



FK
Indaco
Indigo



CK
Pervinca
Periwinkle



OO
Oro
Gold



NN
Nero
Black

Finiture Finishings



NJ
Nickel nero
spazzolato
Brushed Black
Nickel



OJ
Oro Spazzolato
Brushed Gold

PERSEUS

Marcel Wanders Studio

Una scultura luminosa da tavolo, un'emozione di luce, agli antipodi del classico. Composta da un gran numero di elementi in cristallo veneziano che rappresentano un mix delle tecniche vetrarie reinterpretate, accostate e mescolate in modo sovversivo rispetto ai canoni della classicità.

An illuminated sculpture, a lighting emotion, a world away from the classic style. It is composed of a large number of Venetian crystal elements that represent a mix of the glassmaking techniques reinterpreted, paired, and mixed in a subversive way with respect to the canons of classicism.



Modelli e misure Models and sizes

Perseus
7314

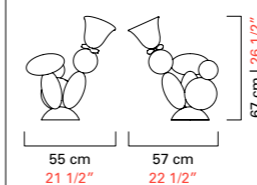

Peso Weight

10 kg
22 lb

Lampadine Bulbs

N.	Tipo	W max.
3	G4	7

Dimmerabile Dimmable

Lampadine incluse Bulbs included

G4 Led

Certificazioni Certification Marks

ERAC

Colori disponibili Available colours



WZ

Cristallo /
Cedro liquido /
Acquamarine / Grigio
/ Bianco
Crystal /
Liquid Citron /
Aquamarine /
Grey / White

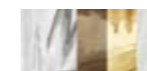

WP

Cristallo / Grigio /
Brown / Cognac /
Bianco
Crystal / Grey /
Brown / Cognac /
White

Finiture Finishings



CL

Cromo Lucido
Polished Chrome

PIGALLE

Tradizione ed innovazione si fondono in questa collezione ispirata alla Belle Époque. Si caratterizza per eleganza e linee sinuose senza risultare eccessiva ed ostentata. Eloquente per raffinatezza e grazia alterna linee semplici, dettagli curvi e lavorazioni tradizionali.

Tradition and innovation blend in this collection inspired by the Belle Époque. It stands out for its elegant, sinuous lines, without ever seeming excessive or ostentatious. With its eloquent refinement and grace, it mixes simple lines, curved details and traditional workmanship.



Modelli e misure Models and sizes

	Pigalle 5677	Pigalle 5678
Peso Weight	12 kg 26 lb	7 kg 15 lb
Lampadine Bulbs	N. Tipo W max. 3 E14 60	N. Tipo W max. 3 E14 60
Dimmerabile Dimmable	D	D
Lampadine incluse Bulbs included		
Certificazioni Certification Marks		

Colori disponibili Available colours



CC
Cristallo
Crystal



OO
Oro
Gold

Finiture Finishings



CL
Cromo Lucido
Polished Chrome



CN
Cromo Nero
Dark Chrome



OJ
Oro Spazzolato
Brushed Gold

Paralumi Shades

Esterno: Cotone
External: Cotton

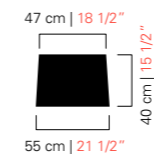

BB
Bianco
White

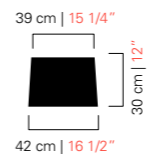

NN
Nero
Black

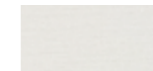

BB
Bianco
White



NN
Nero
Black



NO
Nero Interno Oro
Black Inner Gold

RAN

Trasparenza e leggerezza. Grazie alle ogive soffiate in serie questa piccola lampada da tavolo acquisisce una straordinaria lievità e delicatezza.

Transparency and lightness. Thanks to the mouth blown ogives aligned in series this tiny table lamp appears extremely slight and delicate.



Modelli e misure Models and sizes

	Ran 7180	Ran 7181	Ran 7182
Peso Weight	4 kg 9 lb	7 kg 15 lb	9 kg 20 lb
Lampadine Bulbs	N. Tipo W max. 1 E14 60	N. Tipo W max. 1 E27 100	N. Tipo W max. 1 E27 100
Dimmerabile Dimmable	D	D	D
Lampadine incluse Bulbs included			
Certificazioni Certification Marks			

Colori disponibili Available colours



CC
Cristallo
Crystal



IC
Grigio
Grey



EK
Sabbia
Sand



DK
Oliva
Olive



AK
Blu Cadetto
Cadet Blue



LQ
Bluastro
Bluastro



FK
Indaco
Indigo



CK
Pervinca
Periwinkle



VI
Viola
Violet



OO
Oro
Gold

Finiture Finishings



CL
Cromo Lucido
Polished Chrome



CN
Cromo Nero
Dark Chrome



OF
Ottone
Spazzolato Fine
Fine Brushed Brass

Paralumi Shades

Esterno: Cotone
External: Cotton



BB
Bianco
White



NN
Nero
Black



NO
Nero Interno Oro
Black Inner Gold

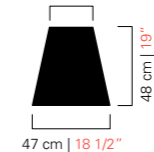
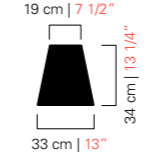
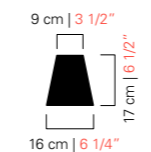

RIVE GAUCHE

Giorgia Brusemini

Una lampada dal sapore anni '50 che racconta la poesia e l'incanto di un prodotto interamente realizzato a mano in cristallo veneziano. Elemento distintivo è la sfera realizzata con la tecnica dell'oro sommerso.

A table lamp that recalls the 50ies style that tells the poetry and enchantment of a product made entirely by hand in Venetian crystal, featuring a distinctive sphere made with the "oro sommerso" technique.



Modelli e misure Models and sizes

Rive Gauche

7068

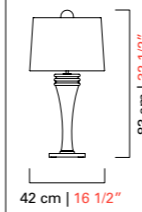

Peso
Weight

8 kg
18 lb

Lampadine N. Tipo W max.
Bulbs N. Type W max.

3 E14 60
E12 60

Dimmerabile
Dimmable

D

Lampadine incluse
Bulbs included

Certificazioni
Certification Marks



Colori disponibili Available colours



CC
Cristallo
Crystal



IC
Grigio
Grey



EK
Sabbia
Sand



DK
Oliva
Olive



AK
Blu Cadetto
Cadet Blue



LQ
Bluastro
Bluastro



FK
Indaco
Indigo



CK
Pervinca
Periwinkle



VI
Viola
Violet



OO
Oro
Gold

Finiture Finishings



CL
Cromo Lucido
Polished Chrome



OG
Oro Galvanizzato
Galvanized Gold

Paralumi Shades

Esterno: Cotone
External: Cotton

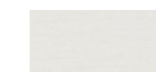
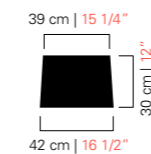

BB
Bianco
White



NN
Nero
Black



NO
Nero Interno Oro
Black Inner Gold

ROTTERDAM

Fusto ogivale e rocchetti di cristallo creati artigianalmente utilizzando un brevetto Barovier&Toso: il "rostrato". Oggetto prezioso, di straordinaria eleganza e raffinatezza capace di soddisfare un cliente esigente e sofisticato.

An oval trunk, crystal spools created by hand using a Barovier&Toso patent: "rostrato". A precious object of extraordinary elegance and refinement, capable of satisfying the most demanding and sophisticated customers.



Modelli e misure Models and sizes

Rotterdam
5565

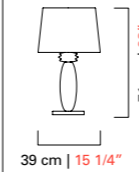

Peso Weight	6 kg 13 lb
Lampadine Bulbs	N. Tipo W max. 1 E27 100 N. Type W max. E26 60
Dimmerabile Dimmable	D
Lampadine incluse Bulbs included	
Certificazioni Certification Marks	

Colori disponibili Available colours



CC
Cristallo
Crystal



IC
Grigio
Grey



EK
Sabbia
Sand



DK
Oliva
Olive



AK
Blu Cadetto
Cadet Blue



LQ
Bluastro
Bluastro



FK
Indaco
Indigo



CK
Perwinca
Periwinkle



VI
Viola
Violet



OO
Oro
Gold

Finiture Finishings



CL
Cromo Lucido
Polished Chrome



CN
Cromo Nero
Dark Chrome



OF
Ottone
Spazzolato Fine
Fine Brushed Brass

Paralumi Shades

Esterno: Cotone
External: Cotton

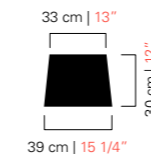

BB
Bianco
White



NN
Nero
Black



NO
Nero Interno Oro
Black Inner Gold

SAINT GERMAIN

Giorgia Brusemini

Una lampada dal sapore anni '50 che racconta la poesia e l'incanto di un prodotto interamente realizzato a mano in cristallo veneziano. Elemento distintivo è la sfera realizzata con la tecnica dell'oro sommerso.

A table lamp that recalls the 50ies style that tells the poetry and enchantment of a product made entirely by hand in Venetian crystal, featuring a distinctive sphere made with the "oro sommerso" technique.



Modelli e misure Models and sizes

Saint Germain
7067

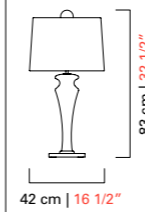

Peso Weight

8 kg
18 lb

Lampadine Bulbs

N.	Tipo	W max.
3	E14	60
	E12	60

Dimmerabile Dimmable

D

Lampadine incluse Bulbs included

Certificazioni Certification Marks



Colori disponibili Available colours



CC
Cristallo
Crystal



IC
Grigio
Grey



EK
Sabbia
Sand



DK
Oliva
Olive



AK
Blu Cadetto
Cadet Blue



LQ
Bluastro
Bluastro



FK
Indaco
Indigo



CK
Pervinca
Periwinkle



VI
Viola
Violet



OO
Oro
Gold

Finiture Finishings



CL
Cromo Lucido
Polished Chrome



OG
Oro Galvanizzato
Galvanized Gold

Paralumi Shades

Esterno: Cotone
External: Cotton



BB
Bianco
White

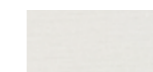

NN
Nero
Black



NO
Nero Interno Oro
Black Inner Gold

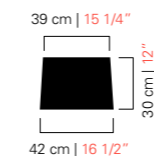

SAMURAI

Angelo Barovier

Angelo Barovier, nel 1966, progettava una lampada con costolature che successivamente è stata ripresa, ingigantita, messa sotto sopra e moltiplicata, fino ad ottenere un oggetto dalle dimensioni generose. Il disegno è caratterizzato da linee piramidali che fanno pensare ad un Samurai in posizione di riposo. Il cristallo veneziano con cui è realizzata è molto massiccio e la sua esecuzione richiede la mano e la forza di un esperto maestro vetraio.

Angelo Barovier had an idea for a ribbed lamp in 1966. Then his design was revisited, but this time inverted, repeated and created on a giant scale. Its pyramid shape recalls of a Samurai at rest. The Venetian crystal used for this piece is extremely massive, and working it requires the skill and strength of an experienced master glassmaker.



Modelli e misure Models and sizes

	Samurai 7052	Samurai 7082	Samurai 7081
Peso Weight	12 kg 26 lb	9 kg 20 lb	7 kg 15 lb
Lampadine N. Tipo W max. Bulbs N. Type W max.	3 E14 60 E12 60	3 E14 40 E12 40	1 E14 40 E12 40
Dimmerabile Dimmable	D	D	D
Lampadine incluse Bulbs included			
Certificazioni Certification Marks			

Colori disponibili Available colours



CC
Cristallo
Crystal



IC
Grigio
Grey



EK
Sabbia
Sand



DK
Oliva
Olive



AK
Blu Cadetto
Cadet Blue



LQ
Bluastro
Bluastro



FK
Indaco
Indigo

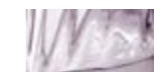

CK
Pervinca
Periwinkle



VI
Viola
Violet



OO
Oro
Gold

Finiture Finishings



CN
Cromo Nero
Dark Chrome



OF
Ottone
Spazzolato Fine
Fine Brushed Brass

Paralumi Shades

Esterno: Cotone
External: Cotton



55 cm | 21 1/2"



38 cm | 15"



20,5 cm
16,5 cm | 6 1/4"
8"



BB
Bianco
White



NN
Nero
Black

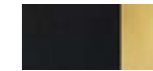

NO
Nero Interno Oro
Black Inner Gold

SARA

Una lampada da tavolo dalla forma generosa e curvilinea impreziosita da una fascia realizzata in foglia d'oro 24K applicata esternamente.

Sinuous and curvy lines for this table lamp whose precious detail is the 24K gold leaf strip applied on the surface.



Modelli e misure Models and sizes

Sara
5574

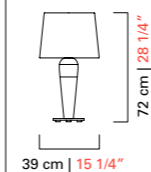

Peso Weight

5 kg
11 lb

Lampadine Bulbs

N.	Tipo	W max.
1	E27	100
	E26	100

Dimmerabile Dimmable

D

Lampadine incluse Bulbs included

Certificazioni Certification Marks



Colori disponibili Available colours



CC
Cristallo
Crystal



IC
Grigio
Grey



EK
Sabbia
Sand

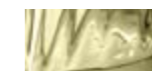

DK
Oliva
Olive



AK
Blu Cadetto
Cadet Blue



LQ
Bluastro
Bluastro



FK
Indaco
Indigo

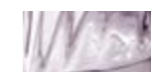

CK
Pervinca
Periwinkle



VI
Viola
Violet



OO
Oro
Gold

Finiture Finishings



CN
Cromo Nero
Dark Chrome



OF
Ottone
Spazzolato Fine
Fine Brushed Brass

Paralumi Shades

Esterno: Cotone
External: Cotton

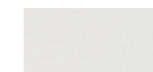
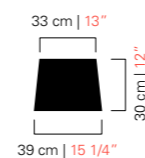

BB
Bianco
White



NN
Nero
Black



NO
Nero Interno Oro
Black Inner Gold

TWINS

Come in un passato mai passato la materia vetro prende forma, e la luce si alterna alle ombre in un vigoroso abbraccio vorticante. Una lampada da tavolo dall'aspetto vigoroso ma raffinato.

In a past that is ever present, the glass takes shape and light alternates with shadows to generate a vigorous, vertiginous embrace. A table lamp with a vigorous yet refined appearance.



Modelli e misure Models and sizes

Twins
7224

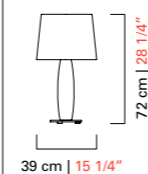

Peso Weight	5 kg 11 lb		
Lampadine Bulbs	N.	Tipo	W max.
	1	E27	100
		E26	60
Dimmerabile Dimmable	D		
Lampadine incluse Bulbs included			
Certificazioni Certification Marks			

Colori disponibili Available colours



CC
Cristallo
Crystal



OO
Oro
Gold

Finiture Finishings



CL
Cromo Lucido
Polished Chrome



CN
Cromo Nero
Dark Chrome



OF
Ottone
Spazzolato Fine
Fine Brushed Brass

Paralumi Shades

Esterno: Cotone
External: Cotton

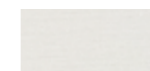
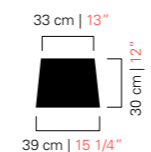

BB
Bianco
White



NN
Nero
Black



NO
Nero Interno Oro
Black Inner Gold

VERONESE

Umberto Riva

Un vaso di cristallo attraversato da un raggio di luce nel famoso quadro di Paolo Veronese che rappresenta l'Annunciazione. A questo si ispirano le linee purissime di questo oggetto riletto in chiave moderna e di grande eleganza. Con la sua luce diffusa e avvolgente questa lampada si inserisce indifferentemente sia in ambienti classici che in arredamenti moderni e contemporanei rendendoli unici ed esclusivi.

A crystal vase crossed by a beam of light, in the famous painting by Paolo Veronese depicting the Annunciation. This is the image behind the pure lines of an object of consummate elegance, reinterpreted in modern terms. With its diffused, enveloping light the lamp fits perfectly into classic and modern decors, bringing them unique, exclusive character.



Modelli e misure Models and sizes

Veronese
6536

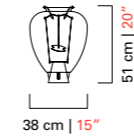

Peso Weight

9 kg
20 lb

Lampadine Bulbs

N.	Tipo	W max.
1	GU10	20

Dimmerabile Dimmable

D

Lampadine incluse Bulbs included

GU10 Led

Certificazioni Certification Marks

ERAC

Colori disponibili Available colours



CC
Cristallo
Crystal



VV
Verdino
Light Green



AA
Ambra
Amber

Finiture Finishings



CN
Cromo Nero
Dark Chrome



FLOOR

Sostengono punti di luce, proiettando impalpabili nuvole luminose. Sono slanciate e lineari oppure affusolate ed adorne di dettagli lungo il fusto. Si inseriscono in modo dinamico nell'ambiente, valorizzando l'arredo e caratterizzando l'atmosfera.

Supporting spots of light they project impalpable clouds of light. They are slender and linear, or tapered and adorned with refined details along the stem. For dynamic insertion in any context, they enhance the decor and define the atmosphere.

AMSTERDAM

Il fascino discreto della luce soffusa, calda e avvolgente. Una lampada che ha il potere di trasformare qualsiasi ambiente in uno spazio accogliente e piacevole giocando con l'alternanza fra volumi opachi e volumi trasparenti, un dialogo fra lavorazioni diverse che esaltano la fattura del prodotto. Elegante e preziosa è caratterizzata da rocchetti in rostrato.

The discreet charm of soft, warm, enveloping light. A lamp that has the power to transform any room into a welcoming, appealing space, alternating opaque and transparent volumes, in a dialogue of different craftings that bring out the fine workmanship of the product. Elegant and precious it is characterized by "rostrato" details.



Modelli e misure Models and sizes

Amsterdam
7352

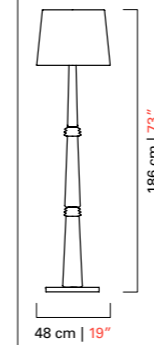

Peso Weight	18 kg 40 lb
Lampadine Bulbs	N. Tipo W max. 1 E27 100 N. Type W max. E26 100
Dimmerabile Dimmable	D
Lampadine incluse Bulbs included	
Certificazioni Certification Marks	UL ENEC UL US

Colori disponibili Available colours

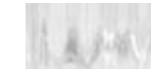

CC
Cristallo
Crystal



IC
Grigio
Grey



EK
Sabbia
Sand



DK
Oliva
Olive



AK
Blu Cadetto
Cadet Blue



LQ
Bluastro
Bluastro



FK
Indaco
Indigo



CK
Pervinca
Periwinkle



VI
Viola
Violet



OO
Oro
Gold

Finiture Finishings



CL
Cromo Lucido
Polished Chrome



CN
Cromo Nero
Dark Chrome



OF
Ottone
Spazzolato Fine
Fine Brushed Brass

Paralumi Shades

Esterno: Cotone
External: Cotton

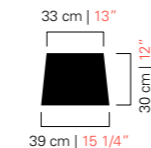

BB
Bianco
White



NN
Nero
Black

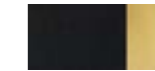

NO
Nero Interno Oro
Black Inner Gold

ERCOLE

Ispirata a un'idea originale di Ercole Barovier risalente agli anni '40 del Novecento e realizzata con l'allora innovativa tecnica del "rostrato", Ercole è una lampada da terra caratterizzata da un ricco effetto di luce che le conferisce preziosità e ricchezza.

Inspired by an original idea by Ercole Barovier in the 1940s and created using the "rostrato" technique he had just invented, the Ercole floor lamp is distinguished by a rich play of light that creates a sense of luxury and richness.



Modelli e misure Models and sizes

Ercole
7355

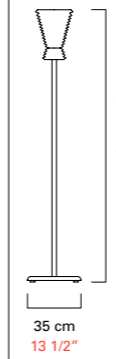

Peso Weight	27 kg 82 lb
Lampadine Bulbs	N. Tipo W max. 1 E27 100 N. Type W max. E26 100
Dimmerabile Dimmable	D
Lampadine incluse Bulbs included	
Certificazioni Certification Marks	UL ENEC UL US

Colori disponibili Available colours



CC
Cristallo
Crystal

Finiture Finishings



CL
Cromo Lucido
Polished Chrome

EVA

Le grandi ogive sospese identificano questa lampada estremamente moderna. La leggerezza è la caratteristica principale che la rende adatta ad ogni progetto di interni.

The great hanging ogives identify this modern floor lamp. Lightness is the main feature which makes it suitable for any interior design project.



Modelli e misure Models and sizes

Eva
7058

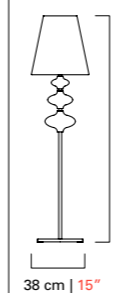

Peso Weight	10 kg 22 lb
Lampadine Bulbs	N. Tipo W max. 1 E27 100 N. Type W max. E26 60
Dimmerabile Dimmable	D
Lampadine incluse Bulbs included	
Certificazioni Certification Marks	UL EAC c UL us

Colori disponibili Available colours



CC
Cristallo
Crystal



IC
Grigio
Grey



EK
Sabbia
Sand



DK
Oliva
Olive



AK
Blu Cadetto
Cadet Blue



LQ
Bluastro
Bluastro



FK
Indaco
Indigo



CK
Pervinca
Periwinkle



VI
Viola
Violet



OO
Oro
Gold

Finiture Finishings



CN
Cromo Nero
Dark Chrome



OF
Ottone
Spazzolato Fine
Fine Brushed Brass

Paralumi Shades

Esterno: Cotone
External: Cotton

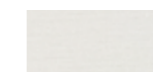
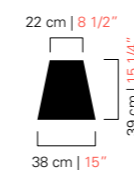

BB
Bianco
White



NN
Nero
Black



NO
Nero Interno Oro
Black Inner Gold

GALLIA

Una lampada da terra elegante ispirata ai canoni classici della simmetria e delle proporzioni, resa senza tempo dai colori caldi e avvolgenti: il diffusore opalino è beige con pagliuzze dorate, mentre varia il colore dell'elemento sferico detto "cipolla".

An elegant floor lamp inspired by the classical canons of symmetry and proportions, rendered timeless by the warm and caressing colours: the opaline diffuser is beige, speckled with gold, while the sphere element, called "cipolla" can be of different colours.

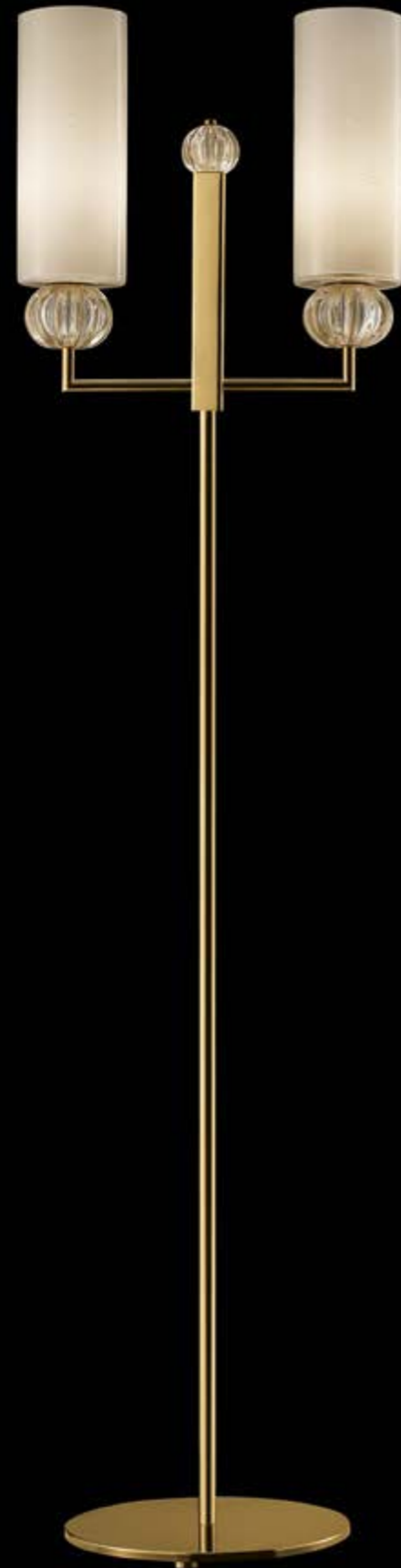

Modelli e misure Models and sizes

Gallia
5626

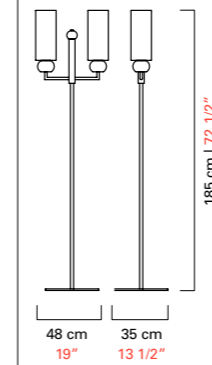

Peso Weight	15 kg 33 lb
Lampadine Bulbs	N. Tipo W max. N. Type W max.
	2 E27 100 E26 60
Dimmerabile Dimmable	D
Lampadine incluse Bulbs included	
Certificazioni Certification Marks	UL EAC c UL US

Colori disponibili Available colours

*A ogni colore è sempre abbinata la foglia oro.
Each colour is always combined with gold leaf.



OO
Oro
Gold

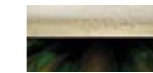

VA
Verde Antalia
Antalia Green



NN
Nero
Black

Finiture Finishings



OG
Oro Galvanizzato
Galvanized Gold



OF
Ottone
Spazzolato Fine
Fine Brushed Brass

MARTA

Una lampada da terra con un fusto molto esile dove sono allineate sfere in cristallo veneziano lavorate con la tradizionale tecnica a "corteccia". La massa vetrosa ancora calda viene fatta rotolare abilmente su di uno stampo piatto a lamelle e poi, successivamente, soffiata per ottenere una superficie irregolare e tridimensionale che ricorda quella della corteccia di un albero.

A floor lamp with a very slender stem bearing aligned Venetian crystal spheres worked with the traditional "corteccia" technique. The hot glass is skilfully turned on a flat lamellar plate and then blown to obtain an irregular three-dimensional surface, resembling the bark of a tree.



Modelli e misure Models and sizes

Marta
5577

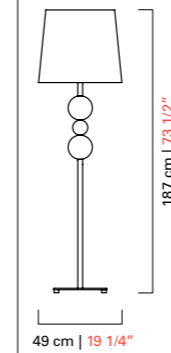

Peso Weight	14 kg 31 lb
Lampadine Bulbs	N. Tipo W max. 1 E27 250 N. Type W max. E26 250
Dimmerabile Dimmable	D
Lampadine incluse Bulbs included	
Certificazioni Certification Marks	UL ENEC c UL US

Colori disponibili Available colours



CC
Cristallo
Crystal



IC
Grigio
Grey



EK
Sabbia
Sand



DK
Oliva
Olive



AK
Blu Cadetto
Cadet Blue



LQ
Bluastro
Bluastro



FK
Indaco
Indigo



CK
Pervinca
Periwinkle



VI
Viola
Violet



OO
Oro
Gold

Finiture Finishings



CL
Cromo Lucido
Polished Chrome



CN
Cromo Nero
Dark Chrome



OF
Ottone
Spazzolato Fine
Fine Brushed Brass

Paralumi Shades

Esterno: Cotone
External: Cotton

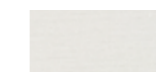
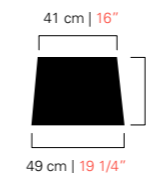

BB
Bianco
White



NN
Nero
Black



NO
Nero Interno Oro
Black Inner Gold

MY MARYLIN

Giorgia Brusemini

Il diffusore è in vetro bianco opalino mentre preziosi rocchetti di cristallo realizzati a mano con la tecnica del "rostrato" avvolgono la base della lampada.

The diffuser is made of white opaline glass while precious crystal spools, handmade with the "rostrato" technique, wrap around the base of the lamp.



Modelli e misure Models and sizes

My Marilyn
6999

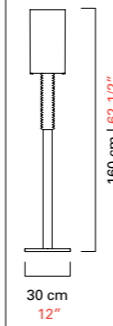

Peso Weight	18 kg 40 lb
Lampadine Bulbs	N. Tipo W max. N. Type W max.
Dimmerabile Dimmable	D
Lampadine incluse Bulbs included	
Certificazioni Cerification Marks	EAC c UL us

Colori disponibili Available colours



CC
Cristallo
Crystal

Finiture Finishings



VM
Verniciato Mirra
Painted Myrrh



VN
Verniciato Nero
Painted Black

OPÉRA

Philippe Nigro

Opéra è una collezione di lampade ispirata all'Opéra Garnier, in cui l'elemento principale è la lavorazione del rostrato. La forma cilindrica va ad enfatizzare il motivo ornamentale, moltiplicando gli angoli di incidenza dei raggi luminosi e creando un fitto involuppo di punte tridimensionali. Alle creazioni in Cristallo Veneziano sono abbinati elementi metallici dalla silhouette molto affine, che circondano e sostengono i corpi luminosi. Il modello da tavolo presenta un'estetica ancora più avvolgente, capace di creare, anche da spenta, un'atmosfera calda e preziosa.

Opéra is a collection of lamps inspired by the Opéra Garnier, where the main feature is the rostrato. The cylindrical form underscores the ornamental motif, multiplying the angles of impact of beams of light and creating a dense wrapping of three-dimensional points. The creations in Venetian Crystal are joined by metal parts with a very similar silhouette, which surround and support the luminous volumes: completely different textures, sharing a specific inspiration in their shapes and substance. The table model has an even more enveloping look, and is able to create a warm, precious atmosphere even when the lamp is off.



Modelli e misure Models and sizes

Opéra
7392

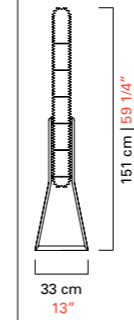

Peso Weight	25 kg 55 lb
Lampadine Bulbs	N. Tipo W max. 1 Strip Led 32 N. Type W max. Strip Led 32
Dimmerabile Dimmable	D
Lampadine incluse Bulbs included	Strip Led
Certificazioni Certification Marks	EAC c UL us

Colori disponibili Available colours



CC
Cristallo
Crystal

Finiture Finishings



NJ
Nickel Nero
Spazzolato
Brushed Black
Nickel



OJ
Oro Spazzolato
Brushed Gold

PERSEUS

Marcel Wanders Studio

Una lampada da terra composta da elementi in cristallo veneziano che rappresentano quasi un compendio delle tecniche vetrarie studiate e sviluppate da Barovier&Toso nel corso della sua lunga storia, qui reinterpretate, accostate e mescolate in modo sovversivo rispetto ai canoni della classicità.

This floor lamp is composed of a large number of Venetian crystal elements that represent a compendium of the glassmaking techniques studied and developed by Barovier&Toso in the course of its long history, here reinterpreted, paired, and mixed in a subversive way with respect to the canons of classicism.



Modelli e misure Models and sizes

Perseus
7313

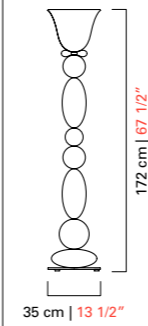

Peso Weight	20 kg 44 lb
Lampadine Bulbs	N. Tipo W max. 1 E27 60 N. Type W max. E26 60
Dimmerabile Dimmable	D
Lampadine incluse Bulbs included	
Certificazioni Certification Marks	UL ENEC UL US

Colori disponibili Available colours



WZ
Cristallo /
Cedro liquido /
Acquamarine / Grigio
/ Bianco
Crystal / Liquid
Citron / Aquamarine
/ Grey / White

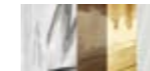

WP
Cristallo / Grigio /
Brown / Cognac /
Bianco
Crystal / Grey /
Brown / Cognac /
White

Finiture Finishings



CL
Cromo Lucido
Polished Chrome

ROTTERDAM

Fusto con elementi ogivali e rocchetti di cristallo creati artigianalmente utilizzando un brevetto Barovier&Toso: il "rostrato". Oggetto prezioso, di straordinaria eleganza e raffinatezza capace di soddisfare un cliente esigente e sofisticato.

A trunk with oval elements and crystal spoils created by hand using a Barovier&Toso patent: "rostrato". A precious object of extraordinary elegance and refinement, capable of satisfying the most demanding and sophisticated customers.



Modelli e misure Models and sizes

Rotterdam

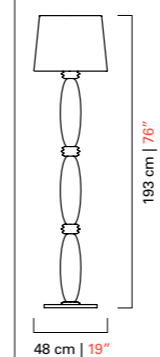
7353

Peso Weight	19 kg 42 lb
Lampadine Bulbs	N. Tipo W max. 1 E27 100 N. Type W max. E26 100
Dimmerabile Dimmable	D
Lampadine incluse Bulbs included	
Certificazioni Certification Marks	UL ENEC UL US

Colori disponibili Available colours



CC
Cristallo
Crystal



IC
Grigio
Grey



EK
Sabbia
Sand

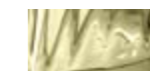

DK
Oliva
Olive



AK
Blu Cadetto
Cadet Blue



LQ
Bluastro
Bluastro



FK
Indaco
Indigo

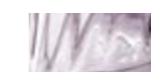

CK
Perivinka
Periwinkle



VI
Viola
Violet



OO
Oro
Gold

Finiture Finishings



CL
Cromo Lucido
Polished Chrome



CN
Cromo Nero
Dark Chrome



OF
Ottone
Spazzolato Fine
Fine Brushed Brass

Paralumi Shades

Esterno: Cotone
External: Cotton

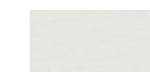
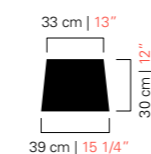

BB
Bianco
White



NN
Nero
Black



NO
Nero Interno Oro
Black Inner Gold

SAMURAI

Angelo Barovier

Angelo Barovier, nel 1966, progettava una lampada con costolature che successivamente è stata ripresa, ingigantita, messa sotto sopra e moltiplicata, fino ad ottenere un oggetto dalle dimensioni generose. Il disegno è caratterizzato da linee piramidali che fanno pensare ad un Samurai in posizione di riposo. Il cristallo veneziano con cui è realizzata è molto massiccio e la sua esecuzione richiede la mano e la forza di un esperto maestro vetraio.

Angelo Barovier had an idea for a ribbed lamp in 1966. Then his design was revisited, but this time inverted, repeated and created on a giant scale. Its pyramid shape recalls of a Samurai at rest. The Venetian crystal used for this piece is extremely massive, and working it requires the skill and strength of an experienced master glassmaker.



Modelli e misure Models and sizes

Samurai
7054

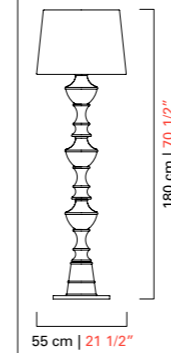

Peso Weight	16 kg 35 lb
Lampadine Bulbs	N. Tipo W max. 3 E14 60 N. Type W max. E12 60
Dimmerabile Dimmable	D
Lampadine incluse Bulbs included	
Certificazioni Certification Marks	UL ENEC UL US

Colori disponibili Available colours



CC
Cristallo
Crystal



IC
Grigio
Grey



EK
Sabbia
Sand



DK
Oliva
Olive



AK
Blu Cadetto
Cadet Blue



LQ
Bluastro
Bluastro



FK
Indaco
Indigo



CK
Pervinca
Periwinkle



VI
Viola
Violet



OO
Oro
Gold

Finiture Finishings



CN
Cromo Nero
Dark Chrome



OF
Ottone
Spazzolato Fine
Fine Brushed Brass

Paralumi Shades

Esterno: Cotone
External: Cotton

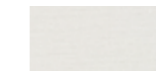
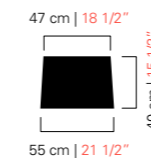

BB
Bianco
White



NN
Nero
Black



NO
Nero Interno Oro
Black Inner Gold



BESPOKE

Ci sono oltre 700 anni di sartorialità Made in Italy in tutto ciò che creiamo. Un “savoir faire” che si svela nella realizzazione di tutti i nostri prodotti, ognuno dei quali ha una sua storia distintiva. Il catalogo Barovier&Toso offre un’ampia gamma di collezioni, ciascuna con innumerevoli possibili combinazioni tra dimensioni, colori del cristallo veneziano, finiture metalliche e paralumi. Se all’interno di questa gamma il cliente non dovesse trovare il suo prodotto ideale, Barovier&Toso è in grado di aiutarlo nella personalizzazione secondo le specifiche esigenze al fine di creare un oggetto unico e prezioso. Essendo infatti ogni prodotto realizzato interamente a mano e in maniera artigianale nelle nostre fornaci di Murano, può essere “cucito” su misura. I nostri consulenti sono sempre a disposizione per guidare il cliente nella personalizzazione del prodotto che può spaziare da piccole variazioni sulle dimensioni e colori sino all’ideazione e creazione di un progetto custom.

Everything we create is based on over 700 years of sartorial prowess Made in Italy. This know-how is clearly perceptible in the making of all our products, each of which has its own distinctive story. The Barovier&Toso catalogue offers a wide range of collections, all with countless possible combinations in terms of size, the colours of Venetian crystal, the metal finishings and shades. Should a customer fail to find his or her ideal product in this range, Barovier&Toso can help to personalize creations based on specific requirements, to generate a unique, precious object. Since every item is made entirely by hand by skilled craftsmen in our glassworks in Murano, the pieces can be truly “tailored” to meet all tastes. Our consultants are always available to guide clients in the personalization of products, ranging from small variations of sizes and colours to the invention and manufacture of a custom design.

Colori disponibili
Available colours

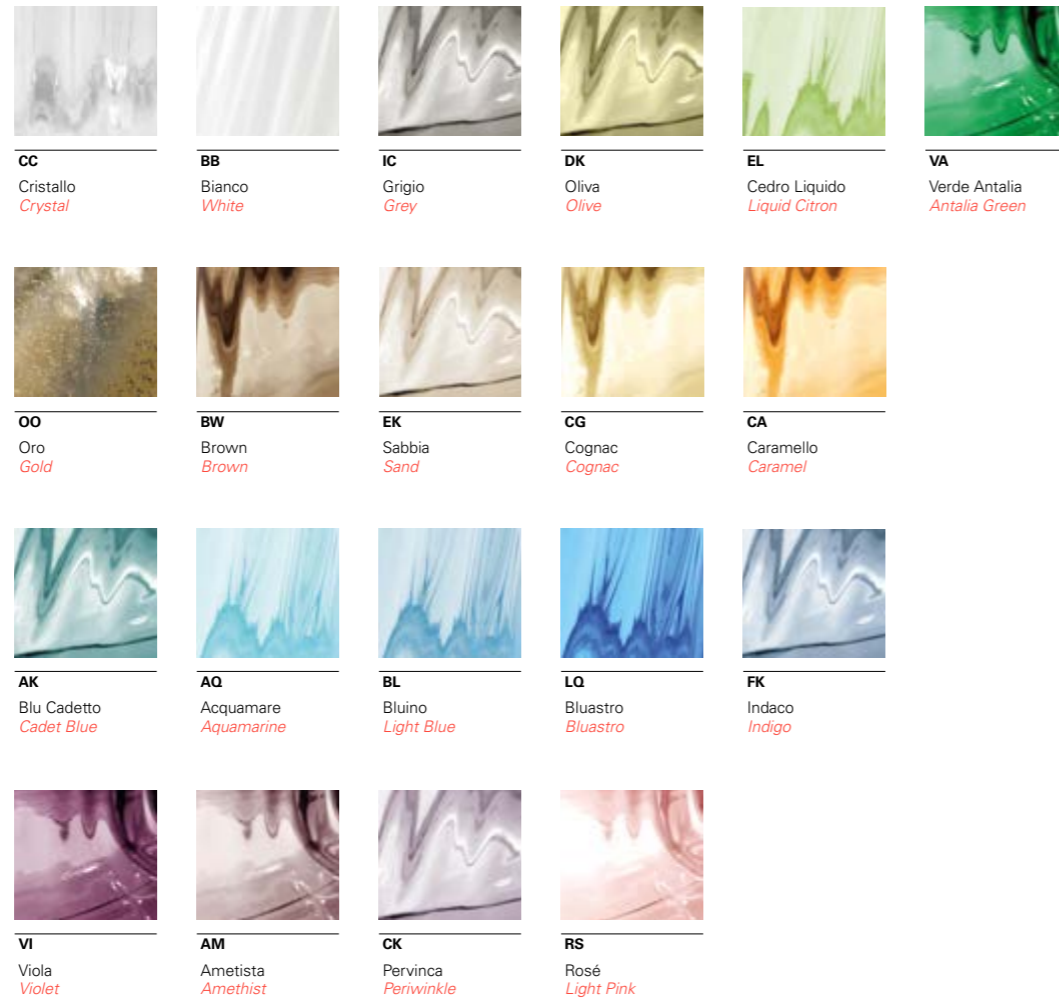

Finiture
Finishing

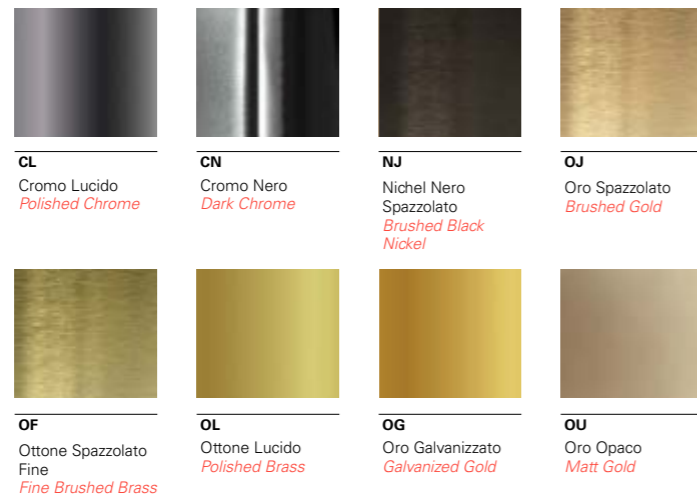

Paralumi Standard
Standard Shades

Esterno: Cotone
External: Cotton



Paralumi Speciali
Special Shades

Esterno: Cotone
External: Cotton



Esterno: Seta
External: Silk

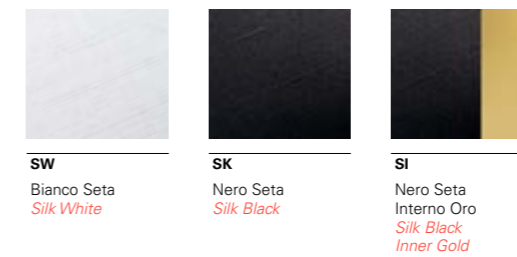

Nota: Per ogni combinazione personalizzata colore vetro, finitura metallica e paralumi va sempre verificata la fattibilità con i nostri Consulenti Commerciali e con il nostro Design Department.
Note: For every customized combination of glass, metal finish and shades, please verify feasibility with our Sales Consultants and our Design Department.

Collezioni Collections	AA Ambra Amber	AM Ametista Amethyst	AK Blu Cadedto Cadet Blue	AQ Acquamarine Aquamarine	BB Bianco White	BL Bluino Light Blue	BW Brown Brown	CA Caramello Caramel	CC Cristallo Crystal	CK Pervinca Periwinkle	CR Cristallo Rugiada Crystal Rugiada	CG Cognac Cognac	DK Oliva Olive	DO Cristallo Decoro Oro Crystal Gold Decoration
Opéra		●	●	●		●			●	●		●	●	
Padma		●	●	●	●	●	●	●	●	●		●	●	
Palladiano					●				●					
Palmette									●					
Palmyra									●					
Pandora		●	●	●		●	●	●	●	●		●	●	
Perseus	Per i colori Standard fare riferimento alla pagina prodotto. Per i colori Bespoke verificare con il nostro Design Department.													
Pigalle		●	●	●		●	●	●	●	●		●	●	
Piume														
Plissé					●									
Première Dame		●	●	●	●	●	●	●	●	●		●	●	
Président		●	●	●	●	●	●	●	●	●		●	●	
Quadri		●	●	●		●	●	●	●	●		●	●	
Rabat		●	●	●		●	●	●	●	●		●	●	●
Ran Ran Round		●	●	●		●	●	●	●	●		●	●	
Redon		●	●	●		●	●	●	●	●		●	●	
Rex										●				
Rive Gauche		●	●	●		●	●	●	●	●		●	●	
Riyadh		●	●	●	●	●	●	●	●	●		●	●	
Robin		●	●	●		●	●	●	●	●		●	●	
Rosati		●	●	●		●	●	●	●	●		●	●	
Rotterdam		●	●	●		●	●	●	●	●		●	●	
Royal										●				
Saint Germain (3)		●	●	●		●	●	●	●	●		●	●	
Samurai		●	●	●		●	●	●	●	●		●	●	
San Giorgio		●	●	●	●	●	●	●	●	●		●	●	
Sara		●	●	●		●	●	●	●	●		●	●	
Spade		●	●	●		●	●	●	●	●		●	●	
Spinn		●	●	●	●	●	●	●	●	●		●	●	
Swing		●	●	●		●	●	●	●	●		●	●	
Taif		●	●	●	●	●	●	●	●	●		●	●	
Tangeri		●	●	●		●	●	●	●	●		●	●	
Taymyr		●	●	●		●	●	●	●	●		●	●	
Topkapi		●	●	●		●	●	●	●	●		●	●	
Torpedo Amsterdam		●	●	●		●	●	●	●	●		●	●	
Torpedo Nevada		●	●	●		●	●	●	●	●		●	●	
Torpedo Taif		●	●	●	●	●	●	●	●	●		●	●	
Torvik (4)		●	●	●	●	●	●	●	●	●		●	●	
Trim		●	●	●		●			●	●		●	●	
Tuileries									●					
Twins (5)									●					
Valiant		●	●	●		●	●	●	●	●		●	●	
Vallonné		●	●	●		●	●	●	●	●		●	●	
Vallonné Opale					●									
Venezia 1295		●	●	●		●			●	●		●	●	
Veronese	●								●					
Vermont		●	●	●		●	●	●	●	●		●	●	
Vertigo		●	●	●		●	●	●	●	●		●	●	
Windsor		●	●	●		●	●	●	●	●		●	●	

● Colori Bespoke | Bespoke Colours
● Colori Standard | Standard Colours

(2) Il colore OO è previsto solo per lampadario, applique e lampada da tavolo. | The OO colour is only available for the chandelier, wall sconce and table lamp.
(3) L'applique è disponibile solo nel colore CC. | The CC colour is the only option for the wall sconce.

EK Sabbia Sand	EL Cedro Liquid Citron	FK Indaco Indigo	GR Champagne Rugiada Champagne Rugiada	IC Grigio Grey	LQ Bluastro Bluastro	NN Nero Black	OB Oro Beige Beige Gold	OO Oro Gold	OR Oro Rugiada Gold Rugiada	PC Policromo Polychrome	RS Rosé Light Pink	VA Verde Antalia Antalia Green	VI Viola Violet	VV Verdino Light Green
●	●	●		●				●			●			
●	●	●		●	●	●		●			●	●	●	
						●								
●	●	●		●	●			●			●	●	●	
●	●	●		●	●			●			●	●	●	
●	●	●		●	●			●			●	●	●	
●	●	●		●	●			●			●	●	●	
●	●	●		●	●	●		●			●	●	●	
●	●	●		●	●			●			●	●	●	
●	●	●		●	●			●			●	●	●	
●	●	●		●	●			●			●	●	●	
●	●	●		●	●			●			●	●	●	
●	●	●		●	●			●			●	●	●	
●	●	●		●	●			●			●	●	●	
●	●	●		●	●			●			●	●	●	
●	●	●		●	●			●			●	●	●	
●	●	●		●	●			●			●	●	●	
●	●	●		●	●			●			●	●	●	
●	●	●		●	●			●			●	●	●	
●	●	●		●	●			●			●	●	●	
●	●	●		●	●			●			●	●	●	
●	●	●		●	●			●			●	●	●	
●	●	●		●	●			●			●	●	●	
●	●	●		●	●			●			●	●	●	
●	●	●		●	●			●			●	●	●	
●	●	●		●	●			●			●	●	●	
●	●	●		●	●			●			●	●	●	
●	●	●		●	●			●			●	●	●	
●	●	●		●	●			●			●	●	●	
●	●	●		●	●			●			●	●	●	
●	●	●		●	●			●			●	●	●	
●	●	●		●	●			●			●	●	●	
●	●	●		●	●			●			●	●	●	
●	●	●		●	●			●			●	●	●	
●	●	●		●	●			●			●	●	●	
●	●	●		●	●			●			●	●	●	
●	●	●		●	●			●			●	●	●	
●	●	●		●	●			●			●	●	●	
●	●	●		●	●			●			●	●	●	
●	●	●		●	●			●			●	●	●	
●	●	●		●	●			●			●	●	●	
●	●	●		●	●			●			●	●	●	
●	●	●		●	●			●			●	●	●	
●	●	●		●	●			●			●	●	●	
●	●	●		●	●			●			●	●	●	
●	●	●		●	●			●			●	●	●	
●	●	●		●	●			●			●	●	●	
●	●	●		●	●			●			●	●	●	
●	●	●		●	●			●			●	●	●	
●	●	●		●	●			●			●	●	●	
●	●	●		●	●			●			●	●	●	
●	●	●		●	●			●			●	●	●	
●	●	●		●	●			●			●	●	●	
●	●	●		●	●			●			●	●	●	
●	●	●		●	●			●			●	●	●	
●	●	●		●	●			●			●	●	●	
●	●	●		●	●			●			●	●	●	
●	●	●		●	●			●			●	●	●	
●	●	●		●	●			●			●	●	●	
●	●	●		●	●			●			●	●	●	
●	●	●		●	●			●			●	●	●	
●	●	●		●	●			●			●	●	●	
●	●	●		●	●			●			●	●	●	
●	●	●		●	●			●			●	●	●	
●	●	●		●	●			●			●	●	●	
●	●	●		●	●			●			●	●	●	
●	●	●		●	●			●			●	●	●	
●	●	●		●	●			●			●	●	●	
●	●	●		●	●			●			●	●	●	
●	●	●		●	●			●			●	●	●	
●	●	●		●	●			●			●	●	●	
●	●	●		●	●			●						

Caratteristiche dei prodotti

Le descrizioni e le illustrazioni del presente catalogo si intendono fornite a titolo indicativo e non impegnativo. Barovier&Toso si riserva il diritto di apportare alle proprie collezioni le eventuali modifiche di parti, dettagli e accessori che ritenesse opportune, in qualunque momento e senza avviso, ferme restando le caratteristiche essenziali dei prodotti qui descritti ed illustrati.

Autenticità, Installazione e Qualità

Ogni prodotto è corredato di Certificato di Autenticità e di libretto di Installazione e Cura, contenente le indicazioni per la corretta installazione e per una manutenzione che preservi il valore e la bellezza della lampada nel tempo. È inoltre accompagnato da una scheda di collaudo sulla quale è indicata la data al confezionamento del prodotto e le sigle di identificazione degli addetti al controllo di qualità. In caso di reclamo, il cliente dovrà sempre fornire copia della scheda. Ogni prodotto è altresì corredato.

Avviso importante

Barovier&Toso non risponde per eventuali danni a persone o cose causati da una non corretta installazione dei propri apparecchi di illuminazione, da un uso di lampadine diverse da quelle prescritte o dalla modifica delle caratteristiche tecnico-costruttive dei prodotti stessi.

Omologazioni

Tutti i nostri lampadari sono omologati

Copyright

Il materiale riportato in questo catalogo e il catalogo stesso sono tutelati dalle leggi sui diritti relativi al copyright, ai marchi commerciali e/o su altri diritti di proprietà intellettuale. Detto materiale è di proprietà di Barovier&Toso Vetrerie Artistiche Riunite srl o delle sue controllate o consociate. Il suddetto materiale comprende, a titolo meramente esemplificativo, fotografie, immagini, illustrazioni, testo, disegni, logo, marchi commerciali, veste commerciale ed eventuale altro materiale contenuto nel catalogo. Tutti i diritti riservati. È vietata la registrazione, memorizzazione, moltiplicazione in copie, riproduzione, ulteriore pubblicazione, esposizione, esibizione, trasmissione, distribuzione, trasferimento, traduzione, trasposizione, modifica, anche parziale, di tali contenuti (consistano essi in informazioni, grafica, testi, immagini e qualsiasi altra espressione creativa) in qualsiasi forma e con qualsiasi mezzo (elettronico, meccanico, telematico, a mezzo di fotocopie, stampe, microfilm, registrazioni su qualsiasi supporto), salvo preventiva e specifica autorizzazione da parte di Barovier&Toso Vetrerie Artistiche Riunite srl. Qualora venga concessa la preventiva autorizzazione scritta alla riproduzione, è fatto comunque obbligo di citarne la fonte.

Marchio registrato

Barovier&Toso è un marchio registrato in tutto il mondo.

Main features of the products

Specifications and pictures contained in this catalogue are indicative but not binding. Therefore, while keeping the main features of the above described models, Barovier&Toso reserves the rights to modify parts, details and fittings of its collection range whenever it deems it necessary, without previous notice to its customers.

Installation instructions and quality test

Each item is accompanied by its own “dossier” including a certificate of authenticity and a card containing quality control inspections and installation instructions. This card shows both the packing date and the identification marks of the inspectors. In case of compliant, the customer should send us a copy of this card, which also contains instructions for correct assembly of the fixture.

Important notice

Barovier&Toso is not liable for injuries or damages due to incorrect installation of its fixtures, use of bulbs different from those prescribed, modification of the original constructional or technical characteristics of the items.

Certifications

All our items comply with the standard of

Copyright notice

All materials on this catalogue and the catalogue itself, are protected by copyrights, trademarks and/or other intellectual property rights. These materials are owned by Barovier&Toso Vetrerie Artistiche Riunite srl or its subsidiaries or affiliates. Such materials include, but are not limited to, the photographs, images, illustrations, text, designs, logos, trademarks and other materials contained in this catalogue. All rights are reserved, worldwide. You may not record, store, copy, reproduce, republish, publicly exhibit, post, transmit, distribute, transfer, translate, transpose, modify, in whole or in part, any such material (information, artwork, text, pictures and the like), in any form or by any electronic, mechanical, photocopying, recording or any other means (including CD-ROM) without first obtaining the case-by-case prior consent of Barovier&Toso Vetrerie Artistiche Riunite srl. When the reproduction has been previously authorized, the use is permitted only if the source for the material has been clearly stated.

Registered trade-mark

Barovier&Toso is a registered trade-mark all over the world.

Certificazioni



Il marchio IMQ è utilizzato per apparecchi elettrici e componenti. Attesta la conformità dei prodotti elettrici ai requisiti delle norme CEI ed EN.



Il certificato cinese obbligatorio, comunemente noto come marchio CCC (China Compulsory Certification), è un marchio di sicurezza elettrica obbligatorio per molti prodotti venduti sul mercato cinese.



I marchi UL e cULus indicano che UL ha testato dei campioni rappresentativi di un prodotto, valutandoli idonei agli standard applicabili o ad altri requisiti, in relazione ai loro potenziali rischi di incendio, shock elettrico e pericoli meccanici. I marchi UL e cULus su un prodotto testimoniano la costante conformità del produttore alle norme di sicurezza applicabili.

EAC

Il certificato di coformità EAC è il marchio di sicurezza dell’Unione Economica Euroasiatica: Federazione Russa, Armenia, Bielorussia, Kazakistan and Kirghizistan. I certificati e le dichiarazioni EAC confermano che il prodotto dell’azienda in oggetto soddisfa i requisiti dei regolamenti tecnici della EAEU ed è sicuro da usare.

Certification Marks



IMQ mark is used for electrical appliances and components. The IMQ mark certifies that electrical products comply with the requirements of CEI and EN standards.



CCC is short for China Compulsory Certification scheme which requires manufacturers to obtain electrical approval for their products before they can be legally marketed in China.



In addition to a typical safety certification, UL also certifies certain products for functional safety. Based on a product’s application and usage, the functional safety assessment is performed in accordance with the requirements of a published and relevant functional safety standard. Functional safety is the part of overall safety that depends on the correct functioning of safety-related control systems and software.

EAC

EAC certificate of conformity is the safety mark for the Eurasian Economic Union: Russian Federation, Armenia, Belarus, Kazakhstan and Kyrgyzstan. EAC Certificates and Declarations confirm that their subject product meets the requirements of Technical Regulations of the EAEU and is safe to use.

CHANDELIERS

4604	24
4607	26
Adonis	28
Agadir	32
Alexandria	34
Amsterdam Domo Torpedo	36
Babylon	42
Baikal	44
Bissa Boba	46
Degas	48
Dhamar	50
Fauve	52
Fez	54
Florian	56
Izmir	58
Magritte	60
Maryland Domo	64
Meknes	70
Metropolis	72
Nekhel	76
Nevada Domo Torpedo	78
Odile	84
Palladiano	86
Pigalle	90
Première Dame	92
Président	94
Quadri	98
Rabat	100
Ran Round	102
Redon	106
Riyadh	108
Rosati	110
Rotterdam	114
Saint Germain	118
San Giorgio	120
Taif Mood Torpedo	122
Tangeri	128
Taymyr	130
Twins	132
Valiant	134
Venezia 1295	136
Vermont	140
Vertigo	142
Windsor	146

SUSPENSIONS

Angel	150
Colimaçon	152
Crown	156
Eva	160
Exagon	162
Fanali Veneziani	164
Gallia	168
Hanami	170
Manhattan	174
Marta	176
Matrioska	178
Medina	182
New Eden	184
New Felci	186
Opéra	190
Padma	194
Palmette	198
Palmyra	202
Pandora	206
Perseus	208
Pigalle	210
Piume	212
Rex	216
Robin	218
Samurai	220
Spade	222
Spinn	224
Swing	228
Trim	232
Vallonné	234
Vallonné Opale	238

CEILING

Alumina	242
Anversa	244
Excelsior	246
Grand Hotel	250
Marrakech	252
New Felci	256
Palmette	258
Pigalle	260
Piume	262
Plissé	264

Rex	266
Royal	270
Spade	272
Topkapi	274
Trim	276

WALL

4604	282
4607	284
Adonis	286
Agadir	288
Alexandria	290
Alumina	292
Amsterdam Domo	294
Angel	296
Anversa	298
Babylon	300
Baikal	302
Bissa Boba	304
Degas	306
Dhamar	308
Excelsior	310
Fauve	312
Fez	314
Florian	316
Gallia	318
Grand Hotel	320
Izmir	322
Magritte	324
Marrakech	326
Maryland Domo	330
Matrioska	332
Medina	334
Meknes	336
Metropolis	338
Nekhel	340
Nevada Domo	342
New Felci	344
Odile	346
Opéra	348
Palladiano	350
Palmette	352
Pandora	354

Perseus	356
Pigalle	358
Piume	360
Plissé	362
Première Dame	364
Président	366
Quadri	368
Rabat	370
Ran Round	372
Redon	374
Rex	376
Riyadh	378
Rosati	380
Rotterdam	382
Saint Germain	384
San Giorgio	386
Spade	388
Taif Mood	390
Tangeri	392
Taymyr	394
Torvik	396
Tuileries	398
Twins	402
Valiant	404
Venezia 1295	406
Vermont	408
Vertigo	410
Windsor	412

TABLE

Amsterdam	416
Camparino	418
Ercole	420
Eva	422
Gallia	424
Grace	426
Marta	428
Medina	430
My Marilyn	432
Opéra	434
Padma	436
Perseus	438
Pigalle	440

Ran	442
Rive Gauche	444
Rotterdam	446
Saint Germain	448
Samurai	450
Sara	452
Twins	454
Veronese	456

FLOOR







Amsterdam	460
Ercole	462
Eva	464
Gallia	466
Marta	468
My Marilyn	470
Opéra	472
Perseus	474
Rotterdam	476
Samurai	478

BESPOKE

Colori Colours	482
Finiture Finishing	482
Paralumi Shades	483

INDICE 2 | INDEX 2

						
PRODUCT	CHANDELIERS	SUSPENSIONS	CEILING	WALL	TABLE	FLOOR
4604	24-25			282-283		
4607	26-27			284-285		
Adonis	28-31			286-287		
Agadir	32-33			288-289		
Alexandria	34-35			290-291		
Alumina			242-243	292-293		
Amsterdam	36-41			294-295	416-417	460-461
Amsterdam Domo	36-41			294-295		
Amsterdam Torpedo	36-41			294-295		
Angel		150-151		296-297		
Anversa			244-245	298-299		
Babylon	42-43			300-301		
Baikal	44-45			302-303		
Bissa Boba	46-47			304-305		
Camparino					418-419	
Colimaçon		152-155				
Crown		156-159				
Degas	48-49			306-307		
Dhamar	50-51			308-309		
Ercole					420-421	462-463
Eva		160-161			422-423	464-465
Exagon		162-163				
Excelsior			246-249	310-311		
Fanali Veneziani		164-167				
Fauve	52-53			312-313		
Fez	54-55			314-315		
Florian	56-57			316-317		
Gallia		168-169		318-319	424-425	466-467
Grace					426-427	
Grand Hotel			250-251	320-321		
Hanami		170-173				
Izmir	58-59			322-323		
Magritte	60-63			324-325		
Manhattan		174-175				
Marrakech			252-255	326-329		
Marta		176-177			428-429	468-469
Maryland	64-69			330-331		
Maryland Domo	64-69			330-331		
Matrioska		178-181		332-333		
Medina		182-183		334-335	430-431	
Meknes	70-71			336-337		
Metropolis	72-75			338-339		
My Marilyn					432-433	470-471
Nekhel	76-77			340-341		
Nevada	78-83			342-343		
Nevada Domo	78-83			342-343		
Nevada Torpedo	78-83			342-343		
New Eden		184-185				
New Felci		186-189	256-257	344-345		
Odile	84-85			346-347		

						
PRODUCT	CHANDELIERS	SUSPENSIONS	CEILING	WALL	TABLE	FLOOR
Opéra		190-193		348-349	434-435	472-473
Padma		194-197			436-437	
Palladiano	86-89			350-351		
Palmette		198-201	258-259	352-353		
Palmyra		202-205				
Pandora		206-207		354-355		
Perseus		208-209		356-357	438-439	474-475
Pigalle	90-91	210-211	260-261	358-359	440-441	
Piume		212-215	262-263	360-361		
Plissé			264-265	362-363		
Première Dame	92-93			364-365		
Président	94-97			366-367		
Quadri	98-99			368-369		
Rabat	100-101			370-371		
Ran					442-443	
Ran Round	102-105			372-373		
Redon	106-107			374-375		
Rex		216-217	266-269	376-377		
Rive Gauche					444-445	
Riyadh	108-109			378-379		
Robin		218-219				
Rosati	110-113			380-381		
Rotterdam	114-117			382-383	446-447	476-477
Royal			270-271			
Saint Germain	118-119			384-385	448-449	
Samurai		220-221			450-451	478-479
San Giorgio	120-121			386-387		
Sara					452-453	
Spade		222-223	272-273	388-389		
Spinn		224-227				
Swing		228-231				
Taif	122-127			390-391		
Taif Mood	122-127			390-391		
Taif Torpedo	122-127					
Tangeri	128-129			392-393		
Taymyr	130-131			394-395		
Topkapi			274-275			
Torvik				396-397		
Trim		232-233	276-279			
Tuileries				398-401		
Twins	132-133			402-403	454-455	
Valiant	134-135			404-405		
Vallonné		234-237				
Vallonné Opale		238-239				
Venezia 1295	136-139			406-407		
Vermont	140-141			408-409		
Veronese					456-457	
Vertigo	142-145			410-411		
Windsor	146-147			412-413		

Barovier&Toso
Vetriere Artistiche Riunite srl

Headquarter
Fondamenta Vetrai 28
30141 Murano Venezia | Italy
T. (+39) 041 739 049
info@barovier.com

Marketing Office
Via Durini 5
20122 Milano | Italy
T. (+39) 02 778 78 600
press@barovier.com

Palazzo Barovier&Toso
Fondamenta Manin 1/D | 30141 Murano
palazzo@barovier.com

Showroom Barovier&Toso
Via Durini 5 | 20122 Milano
showroom.milano@barovier.com

barovier.com

Segnalibri | Bookmarks

Lampadario
Chandelier

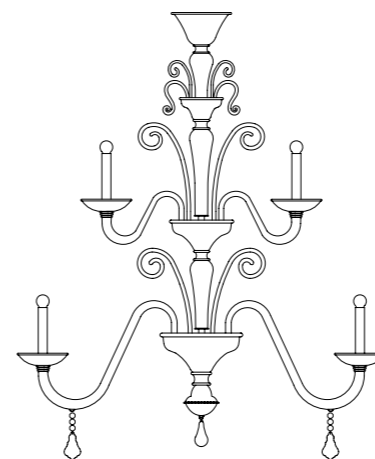

Sospensione
Suspension

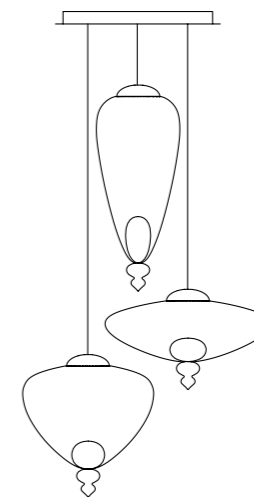

Soffitto
Ceiling

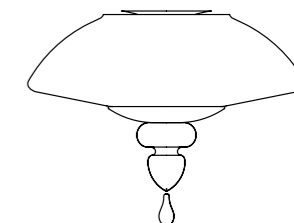

Parete
Wall

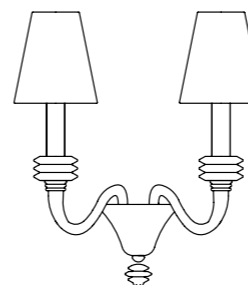

Tavolo
Table

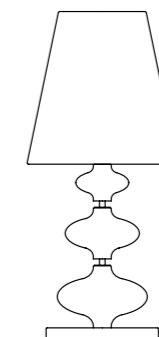

Terra
Floor

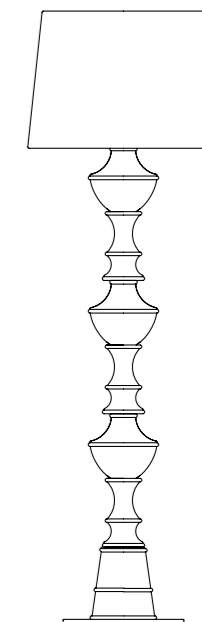

Soffitto
Ceiling

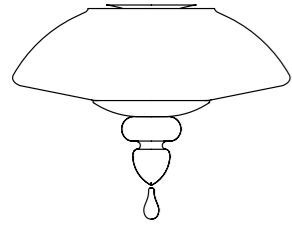

Sospensione
Suspension

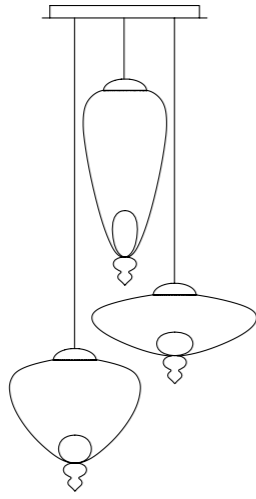

Lampadario
Chandelier

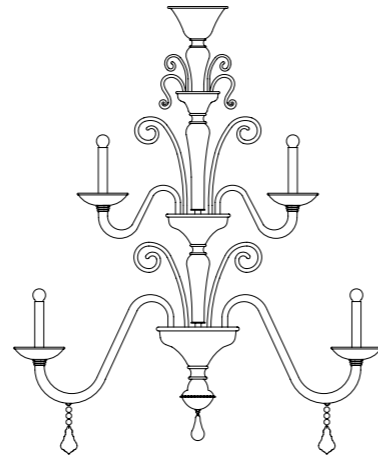

Terra
Floor

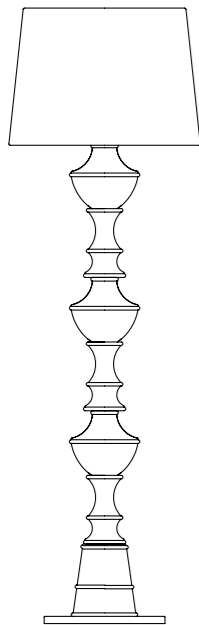

Tavolo
Table

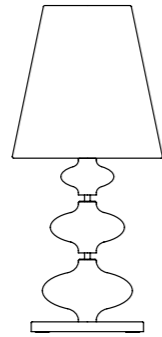

Parete
Wall

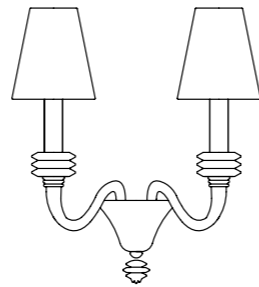



barovier.com